

DEURPANELEN
PANNEAUX DE PORTE

03•2023

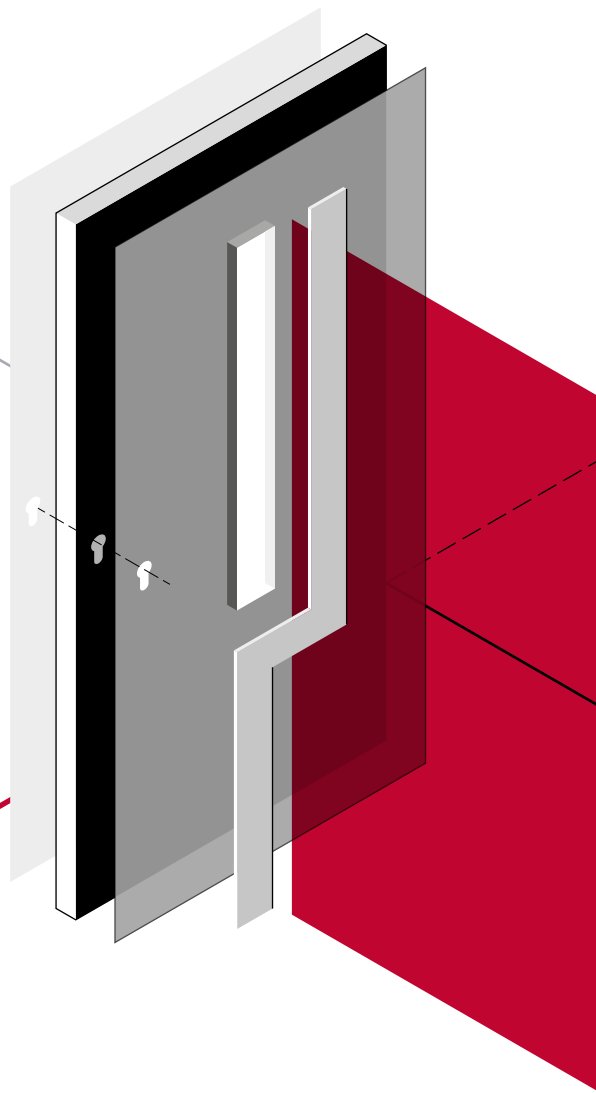

FORM FOLLOWS FUNCTION.

frager.

CREATORS OF DOORS

PRIJSLIJST • TARIF
€ BRUTO • BRUT €
versie • version 01/03/2023

info

ALFABETISCHE LIJST LISTE ALPHABETIQUE	3
FACADE	5
MAGNETUDE	7
OVERZICHT OPTIES APERÇU OPTIONS	12
INFOGRAPHICS	20

m modern

MINIMAL	22	■
PRESIDENTIAL	23	
DIMENSIONAL	25	
ARBRAS	27	
TUBED	28	
RETRO	32	
UNIQUE	33	
BAUHAUS	35	■
SOLINOX	39	■
IMAGINE	48	■

t timeless

DECOVER	52	■
RAINURE	58	■
V-FORM	60	■
SOLO	63	■
LIGHT DESIGN	73	■
MONDIAL	85	■
TOPLINE	92	■
MONTY	101	■

c classic

TRADITION	115	■
DIAMANT	117	
EXPANSION	118	
CLASSICS	119	
ROMANESQUE	121	
PROGRESS	125	■
ALUFIX	135	■

a appendix

DEURBESLAG QUINCAILLERIE	149	■
VLAKKE PANELEN PANNEAUX LISSES	168	■
WEBSHOP	176	



NIEUWE NAAM NOUVEAU NOM	ID NR N°	OUDE NAAM ANCIEN NOM	PAG.
ABRUZZO	LD341	EQUILINE 5	82
ALTO	SO141 2	19410 T2 SOPRANO	67
AMALFI	LD321	EQUILINE 3	82
AMBASSADE	TO091	870	98
AMBASSADE	TO092	4710	98
AMON	MI301 2	FLAT + TUBE 016 HOR	28
AMSTERDAM	LD021	902	75
ANDALUSIA	SX231	EQUINOX 4	45
ANDORRA	AF121	104110	143
ANGELA	SO071	21530 ANGEL	66
ANGELINO	LD031	21530 ANGEL	75
ANITA	SO091 2	24250	66
ANUBIS	MI381 2	FLAT + TUBE 051 HOR	30
AOSTA	LD371	EQUILINE 8	83
APATJET	DI011	DIAMANT K1/2	117
APOLLO	MI291 2	FLAT + TUBE 011 VER	28
APULIA	LD331	EQUILINE 4	82
AQUINO	SX151	DESIGN K	44
AQUITAINE	SO281	EQUISOL 6	70
ARAGON	SX261	EQUINOX 7	46
ARDECHE	SO321	EQUISOL 10	71
ARES	MI281 2	FLAT + TUBE 011 HOR	28
ARIANE	LD261	LD DESIGN C	80
ARNE	SO101	24830	66
ARNOX	SX121 2	59050	42
ARTEMIS	MI391 2	FLAT + TUBE 051 VER	30
ARTOX	SX141	59810	43
ASTURIA	SX281	EQUINOX 9	46
ATLANTA	MY161	70600	108
ATLANTA	MY162	70620	109
ATLAS	LD281	LD DESIGN E	80
AUVERGNE	SO301	EQUISOL 8	71
AVERIL	SO061	24530	65
AZURA	MY171	70800	109
AZURA	MY172	70810	109
BACCHUS	MI401 2	FLAT + TUBE 052 HOR	30
BACH	TR011		120
BACON	SX181	DESIGN N	44
BALEARES	SX251	EQUINOX 6	45
BALINE	LD141	96110	77
BARIMON	SO151 2	19410 T3 SOPRANO	67
BARTOK	TR051		120
BASIL	MI231 2	3D BASIL	25
BASSO	SO131 2	19410 T1 SOPRANO	67
BEEL	EX061	EXPANSION K2 + V1	118
BEIROET	AF181		144
BELLINI	IM031 2	IM 4X10	50
BELVEDERE	AF141	105110	143
BERLIOZ	TR061		120
BERNINI	PR021	PR 20A	128
BERNINI	PR022	PR 20B	128
BERNINI	PR023	PR 21A	128
BERNINI	PR024	PR 21B	128
BERNINI	PR025	PR 22A	128
BERNINI	PR026	PR 22B	128
BILBAO	AF031	103200	138
BILBAO	AF032	103210	138
BORVO	MI691 2	FLAT + TUBE 013 VER	29
BOTTICELLI	IM021 2	IM 2X20	50
BOURGONDIE	SO311	EQUISOL 9	71
BRAMANTE	PR031	PR 30A	129
BRAMANTE	PR032	PR 30B	129
BRAMANTE	PR033	PR 31A	129
BRAMANTE	PR034	PR 31B	129
BRAMANTE	PR035	PR 32A	129
BRAMANTE	PR036	PR 32B	129
BRAMANTE	PR037	PR 33A	130

NIEUWE NAAM NOUVEAU NOM	ID NR N°	OUDE NAAM ANCIEN NOM	PAG.
BRAMANTE	PR038	PR 33B	130
BRANDT	BH021 2		36
BRETAGNE	SO271	EQUISOL 5	70
BREUER	BH011 2		36
BRIKITA	SO011	11520	65
BRUNELLESCHI	PR041	PR 40A	130
BRUNELLESCHI	PR042	PR 40B	130
BRUNELLESCHI	PR043	PR 42A	130
BRUNELLESCHI	PR044	PR 42B	130
BRUNELLESCHI	PR045	PR 44A	131
BRUNELLESCHI	PR046	PR 44B	131
BUCHANAN	MI611 2	JEFFRA 2	23
BURGOS	AF021	103100	138
BURGOS	AF022	103110	138
CADENS	LD101	94130	76
CADRAGE	LD191	97410A	78
CADRAGE	LD192	97410B	78
CALABRIA	LD391	EQUILINE 10	83
CALATRAVA	EX011	EXPANSION K1/2	118
CALINE	LD161 2	96340	78
CALLOX	SX111 2	59040	42
CALLU	SO041	17740	65
CAPLET	TR121	GRIEG 1/4	122
CARAVAGGIO	IM011 2	IM 1Y20	50
CARBOON	SO351	UNIC 5	69
CARLOS	SO031 2	48035	65
CATALUNIA	SX291	EQUINOX 10	46
CHARON	MI411 2	FLAT + TUBE 052 VER	31
CHATEAU	TO061	650	96
CHATEAU	TO062	2510	96
CHATEAU	TO063	2520	97
CLARA	MY211	25740	110
COLOBUS	MI571 2		32
COMPTA	SO111	72250	66
CORROX	SX301		43
COTTAGE	LD211	98510A	79
COTTAGE	LD212	98510B	79
DEBORA	MY191	25130	109
DEVOON	SO331	EQUISOL 3	70
DIEGO	MY181	607/OND	109
DORDOGNE	SO291	EQUISOL 7	71
DOREA	AF061	102200	140
DOREA	AF062	102210	140
DOREA	AF063	102220	140
DOREA	AF064	102230	140
ELEGANCE	TO011	510	94
ELEGANCE	TO012	1110	94
ELEGANCE	TO013	515	94
ELEGANCE	TO014	1115	94
ELENA	MY081	80800	105
ELENA	MY082	80820	105
ELGAR	TR091	ELGAR 3/4	122
ELZAS	SO261	EQUISOL 4	70
ENNIO	MO131 2	63830	89
ENTOURAGE	LD221	98610A	80
ENTOURAGE	LD222	98610B	80
ERASMUS	MO191	MO DESIGN C	91
EUPORIE	MI161 2	ONE 7.10	33
EVA	MY061	60800	104
EVA	MY062	60810	104
EVA	MY063	60850	104
FALCON	LD241	LD DESIGN A	80
FAURE	TR081	SATIE 1/4	122
FILOX	SX011 2	57830	41
FINISSAGE	SO191	76410B	68
FIXETE	VF091	V-FORM XPS VERTICAL	62
FIXINA	VF101	V-FORM XPS 1/2 VERTICAL	62

NIEUWE NAAM NOUVEAU NOM	ID NR N°	OUDE NAAM ANCIEN NOM	PAG.
FIXLINE	LD171 2	96410	78
FIXLINE	LD173 4	96410	78
FIXORA	VF081	V-FORM XPS HORIZONTAL	62
FIXORINA	VF121	V-FORM XPS 1/2 HORIZONTAL	62
FLANDRIA	SO051	17830	65
FLUORIET	DI031	DIAMANT K2	117
FREELINE	LD151 2	96210	77
FREELINE	LD153 4	96210	77
FREUD	MO221	MO DESIGN I	91
FREYA	MI451	FLAT	28
GALA	MO051	621	88
GALICIA	SX271	EQUINOX 8	46
GRIEG	TR111	GRIEG 3/4	122
GROPIUS	BH071 2		37
HADES	MI311 2	FLAT + TUBE 016 VER	29
HADID	EX051	EXPANSION K4	118
HARRISON	MI621 2	JEFFERSON 1	23
HEPPY	SO121 2	82610	66
HEPRO	LD081 2	93610	76
HEPTOX	SX061 2	53610	41
HERA	MI321 2	FLAT + TUBE 017 HOR	29
HERMES	MI421 2	FLAT + ART 290 S	31
HERMITAGE	LD121	94410A	76
HERMITAGE	LD122	94410B	77
HERMITAGE	LD122	94410B	77
HOLOCEEN	SO371		69
HORTA	PR051	PR 70	132
HORTA	PR052	PR 71	132
HORTA	PR053	PR 71V	132
HORTA	PR054	PR 71G	132
HUBBLE	MI061 2	UNO 5.0	33
ISIS	MO021 2	141	87
JACKSON	MI631 2	JEFFERSON 2	23
JEF	MI251 2	3D JEF	25
JOHNSON	MI531 2	JEFFERSON 123	24
JUNIOR	MO071 2	95010	88
JUNO	MI341 2	FLAT + TUBE 018 HOR	29
JURA	SO201	75410B UNIC1	68
JUUL	MI191 2	3D JUUL	25
KAHN	PR061		131
KANDINSKY	BH091 2		37
KANT	MO181	MO DESIGN B	91
KEPLER	MI041 2	UNO 4.0	33
KLEE	BH041 2		36
KOBE	LD041 2	92120	75
KRIJT	SO341	75420B UNIC2	68
LAMBRISSE	LD231	98710A	80
LAMBRISSE	LD232	98710B	80
LAMPENS	EX031	EXPANSION K2	118
LAZIO	LD311	EQUILINE 2	82
LEE	MO111 2	25420	89
LEMUR	MI581 2		32
LEON	MI201 2	3D LEON	25
LEVINAS	SX171	DESIGN M	44
LIECHTENSTEIN	AF131	104210	143
LIGURIA	LD381	EQUILINE 9	83
LINCOLN	MI511 2	JEFFERSON 13	24
LINEA	MO041	162	87
LITRES	MO151 2	693	90
LIUNO	MO141 2	691	89
LOCASTE	MI121 2	ONE 6.0	33
LOKI	MI591 2		33
LORD	LD051	92330	75
LOU	MI671 2		26
LUCA	MY101	80100	106
LUCA	MY102	80110	106
LUCA	MY103	85100	106

NIEUWE NAAM NOUVEAU NOM	ID NR N°	OUDE NAAM ANCIEN NOM	PAG.
LUCA	MY104	85110	106
MADISON	MO081 2	211	88
MADRID	AF101	102800	142
MADRID	AF102	102820	142
MADRID	AF103	102809	142
MADRID	AF104	102819	142
MADRID OND	AF161	102802	144
MAGPIE	MI541 2		32
MALACHIET	DI061	DIAMANT K4	117
MANCHA	SX241	EQUINOX 5	45
MARIAGE	MO161	64410A	90
MARIAGE	MO162	64410B	90
MARIAGE	MO163	64410B	90
MASTER	LD061	92430	75
MATHILDA	MY071	80700	105
MATHILDA	MY072	80710	105
MATTEO	TO101	750	98
MATTEO	TO102	3510	98
MAXIMA	MY051	60700	104
MAXIMA	MY052	60710	104
MERLIN	MI661 2	FLAT + TUBE 021 VER	28
MINERVA	MI351 2	FLAT + TUBE 018 VER	30
MIRA	MY091	80907	105
MIRA	MY092	80917	105
MODE	MO031	146	87
MODE	MO032	14610	87
MODEST	MI261 2	3D MODEST	25
MOHOLY	BH051 2		36
MONOX	SX051 2	53010	41
MONZA	TO021	530	94
MONZA	TO022	1320	94
MONZA	TO023	1340	95
MORPHEUS	MI431 2	FLAT + ART 291 S	31
MORRIGAN	MI651 2	FLAT + TUBE 021 HOR	28
MURCIA	SX221	EQUINOX 3	45
NANOX	SX041 2	58430	41
NARCA	MY201	25430	109
NARCIS	SO081 2	18430	66
NAVARRA	SX211	EQUINOX 2	45
NEVADA	MY131	60600	107
NEVADA	MY132	60630	108
NEW YORK	LD011	901	75
NIKITA	TO051	630	96
NIKITA	TO052	2310	96
NIKITA	TO053	2370	96
NIXON	MI501 2	JEFFERSON 12	23
NORMANDIE	SO251	EQUISOL 2	70
NOUVEL	PR071		131
OCTAVE	LD091 2	93710	76
OCTOX	SX071 2	53710	42
OCTRO	MO121 2	63710	89
ODIN	MI361 2	FLAT + TUBE 050 HOR	30
ORAK	MO091	217	88
ORAK	MO092	21710	88
OSCAR	MI181 2	3D OSCAR	25
PALLADIO	PR011	PR 10A	127
PALLADIO	PR012	PR 10B	127
PALLADIO	PR013	PR 11A	127
PALLADIO	PR014	PR 11B	127
PALLADIO	PR015	PR 12A	127
PALLADIO	PR016	PR 12B	127
PAOLA	MY121	50300	106
PAOLA	MY122	50320	107
PAOLA	MY123	50340	107
PAOLA	MY124	55300	107
PAOLA	MY125	55320	107
PAOLA	MY126	55340	107

NIEUWE NAAM NOUVEAU NOM	ID NR N°	OUDE NAAM ANCIEN NOM	PAG.
PARIJS	AF081	101720	142
PASCAL	SX191 2	DESIGN O	44
PAVERA	TO071	670	97
PAVERA	TO072	2710	97
PAVERA	TO073	2720	97
PAVONA	MY141 3	70400	108
PAVONA	MY142 4	70410	108
PEI	EX041	EXPANSION K3	118
PERIDOOT	DI021	DIAMANT K1	117
PERM	SO211	75420B UNIC2	68
PETRA	MY011	50100	102
PETRA	MY012	50110	102
PLATO	MO171	MO DESIGN A	91
PLAYA	SO021 2	13045	65
PLEISTOCEEN	SO361		69
PLEYADA	MY151	80200	108
PLEYADA	MY152	80210	108
PLIOCEEN	SO381		69
PORTO	AF051	102100	140
PORTO	AF052	102110	140
PORTO OND	AF151	102102	143
PRAAG	AF071	101500	141
PRAAG	AF072	101520	141
PRAAG	AF073	101540	141
PRAAG	AF074	101509	141
PRAAG	AF075	101519	141
PRAAG	AF076	101529	141
PRATO	AF041	106200B	138
PRATO	AF042	106210B	138
PRATO	AF043	106300B	139
PRATO	AF044	106330B	139
PRATO	AF045	106400B	139
PRATO	AF046	106420B	139
PRATO	AF047	106102B	139
PRATO	AF048	106400B	139
PRESTO	MO011 3	131	87
PRESTO	MO012 4	13110	87
PRILINE	LD131 2	96010	77
PRILINE	LD133 4	96810B COMLINE	77
PRIMOX	SX091 2	59210	42
PROVENCE	SO241	EQUISOL 1	70
PUGLIA	LD351	EQUILINE 6	82
RAHORA	RN021	HORIZONTAL	59
RAVEL	TR101	ELGAR 1/4	122
RAVETE	RN011	VERTICAL	59
RIA	MY031	60300	103
RIA	MY032	60310	103
RIA	MY033	60370	103
RIOJA	SX201	EQUINOX 1	45
RITMO	LD111	94230	76
ROBIJN	DI041	DIAMANT K3	117
ROHE	BH081 2		37
ROSAMAR	MO061 2	19110	88
ROTOX	SX031	67910	41
ROYAL	TO031	540	95
ROYAL	TO032	1410	95
ROYAL	TO033	1420	95
SAFFIER	DI051	DIAMANT K4	117
SARA	MO101 2	25310	89
SARA	MO103 4	25315	89
SARTRE	MO211	MO DESIGN H	91
SATIE	TR071	SATIE 3/4	122
SATURN	LD271	LD DESIGN D	80
SENSA	MY221	25250	110
SILUUR	SO231	75440B UNIC 4	69
SIRONA	MI681 2	FLAT + TUBE 013 HOR	29
SKYBOX	SX131 2	59710	43

NIEUWE NAAM NOUVEAU NOM	ID NR N°	OUDE NAAM ANCIEN NOM	PAG.
SMETANA	TR041		120
SOFIA	MY041	60500	103
SOFIA	MY042	60510	103
SOFIA	MY043	65500	103
SOFIA	MY044	65510	104
SOPRANO	SO161 2	19410 T4	67
SPINOZA	MO201	MO DESIGN G	91
SPONDE	MI141 2	ONE 8.0	33
STAM	BH031 2		36
STEINER	EX021	EXPANSION K1	118
STETOX	SX081	59010	42
TAPIR	MI551 2		32
TASTE	LD071	92630	76
TEMPO	TO081	840	97
TEMPO	TO082	4410	97
TENOR	SO171 2	19410 T5 SOPRANO	67
THOR	MI371 2	FLAT + TUBE 050 VER	30
TINA	MY021	50400	102
TINA	MY022	50410	102
TINA	MY023	55400	102
TINA	MY024	55410	102
TINTORETTO	IM051 2	IM 9X10	50
TITAN	LD291	LD DESIGN F	81
TIZIANO	IM061 2	IM 11X10	50
TOROX	SX021 2	57910	41
TOSCANE	LD301	EQUILINE 1	82
TREDOX	SX101 2	59030	42
TRIAS	SO221	75430B UNIC3	68
TRUMAN	MI601 2	JEFFRA 1	23
UMBRIA	LD361	EQUILINE 7	83
VEDUO	VF011	MES A	61
VEGA	LD251	LD DESIGN B	80
VEHORA	VF051	V-FORM XPS HORIZONTAL	61
VEHORINA	VF111	V-FORM XPS 1/2 HORIZONTAL	61
VENETIE	AF111	102010	143
VENETIE	AF112	102050	143
VENUS	MI331 2	FLAT + TUBE 017 VER	29
VEPARA	VF021	MES B	61
VERCA	MY111	60200	106
VERMEERSCH	SX161	DESIGN L	44
VERNISSAGE	SO181	74410A	67
VERNISSAGE	SO182	74410B	68
VERROCCHIO	IM041 2	IM 6Y20	50
VETRIO	VF031	MES C	61
VEVEN	VF041	MES D	61
VEVESTINA	VF071	V-FORM XPS 1/2 VERTICAL	62
VEVETE	VF061	V-FORM XPS VERTICAL	61
VIKTORIA	TO041	580	95
VIKTORIA	TO042	1860	95
VIKTORIA	TO043	1880	96
VINTAGE	LD201	98410A	79
VINTAGE	LD202	98410B	79
VINTAGE	LD203	98410B	79
VIVALDI	TR031		120
WAGENFELD	BH061 2		36
WAGNER	TR021		120
WARBLER	MI561 2		32
WASHINGTON	MI521 2	JEFFERSON 23	24
WENEN	AF011	101200	137
WENEN	AF012	101210	137
WENEN	AF013	101220	137
WENEN	AF014	101209	137
WENEN	AF015	101219	137
WENEN	AF016	101229	137
WILSON	MI641 2	JEFFERSON 3	23
WODAN	MI441 2	FLAT + ART 292	31
YORK	AF091	102410	142



NL



FR



EEN NIEUW TIJDPERK IN GEVELBEKLEDING

Met het **gepatenteerd Magnetude®-systeem** voor inkomdeuren van FRAGER, kunnen nu ook gevelbekledingen **onzichtbaar** bevestigd worden.

De architect heeft **alle vrijheid** bij het ontwerpen van een **aluminium gevelbekleding**.

De combinatie van vlakke aluminiumplaten met inliggende schaduwvoeg, strakke binnenhoek- en buitenhoekoplossingen, laten **een hedendaagse en minimalistische vormgeving** toe.

Gevelkaders, op maat geleverd, worden aan de muur geschroefd. Daarna wordt de inliggende aluminium schaduwvoeg, plint of hoek in het gevelprofiel geschoven en kan er een volgend gevelkader worden gemonteerd. De aluminium buitenplaat, tevens op maat geleverd, wordt met magneten op het gevelkader gemonteerd.

Gevelbekledingen en **sectionaalpoorten** worden zo onzichtbaar bevestigd zonder lijm of silicone.

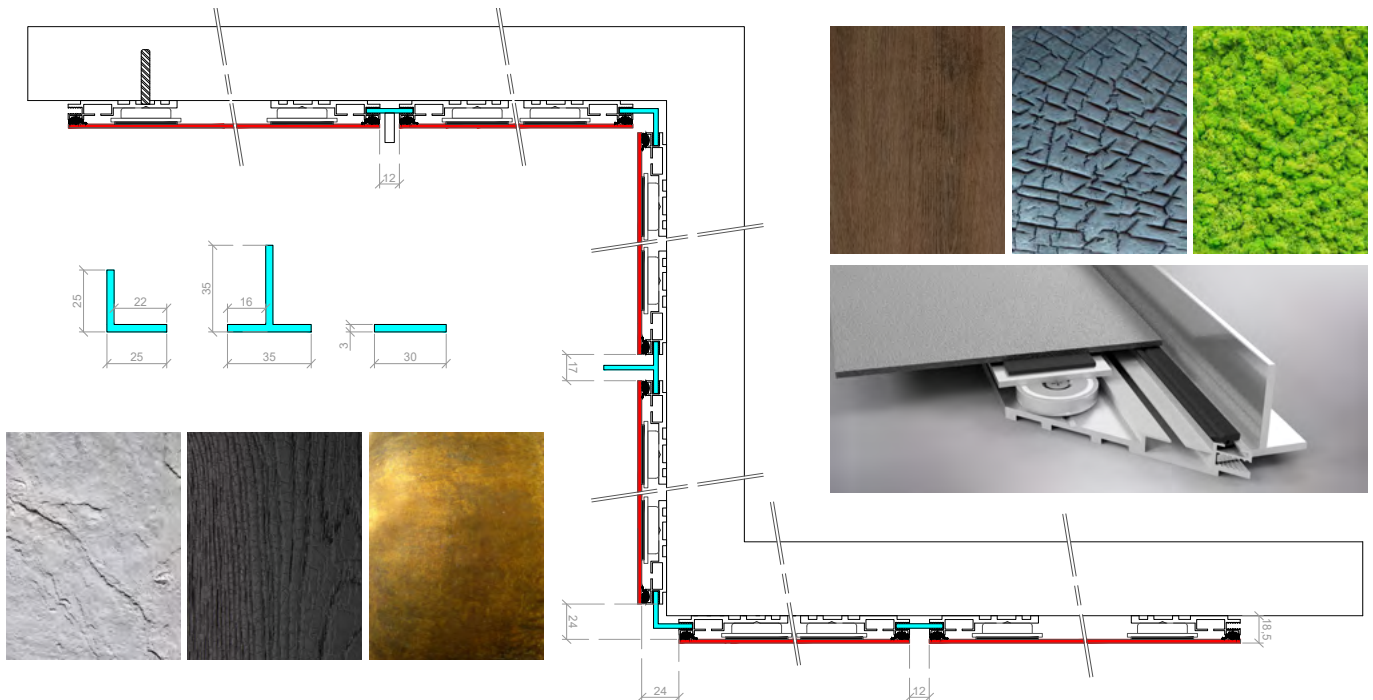

DE VOORDELEN

- Laat dilatatie toe (uitzetting en inkrimping) zonder hechtingsverlies
- Onzichtbare bevestiging en inliggende schaduwvoeg
- Deur, garagepoort en gevel kunnen in zelfde materiaal én gelijkliggend worden gemonteerd.
- Tijdsbesparing en weersonafhankelijkheid bij montage
- Alle platen afzonderlijk vervangbaar
- Ontwerpvrijheid voor architect
- Ledverlichting integreerbaar met geperforeerde buitenplaat volgens uw ontwerp
- Duurzaam in de tijd door het materiaal en de vervangbaarheid
- Circulair in de toekomst: onderdelen apart recycleerbaar
- Mogelijkheid om andere gevelmaterialen dan aluminium poederlak te gebruiken.
- Houtimitatie zoals PVC ramen, spiegel, koper, messing, gebrand hout, keramiek, natuursteen, gevelgroen, zonnepanelen etc.

UNE NOUVELLE ÈRE DANS LE DOMAINE DU BARDAGE

Utilisant **le système breveté Magnetude®** pour les portes d'entrée FRAGER, les bardages FRAGER FACADE peuvent désormais également être **posés de manière invisible**.

L'architecte dispose alors d'une **entière liberté** lors de la conception ou du **ravallement d'une façade en aluminium**.

La combinaison de tôles lisses en aluminium avec insert, des solutions d'angles intérieures et extérieures épurées permettent **un design contemporain et minimaliste**.

Des cadres de façade, fournis sur mesure, sont vissés contre le mur. Ensuite, l'insert dans l'aluminium, la plinthe ou les coins sont glissés dans le profilé de façade. Le cadre suivant peut alors être posé. La plaque extérieure en aluminium, également fournie sur mesure, est montée sur les différents cadres à l'aide d'aimants.

Les **façades**, les **habillages de portes sectionnelles**, ... sont montées avec fixations invisibles **sans utilisation de colle ni de silicone**.

LES AVANTAGES

- Permet la dilatation (expansion et contraction) sans perte d'adhésion
- Fixation invisible et finition avec insert
- La porte, la porte de garage et la façade peuvent être montées dans les mêmes matériaux et affleurants
- Gain de temps lors du montage et ne dépend pas des intempéries extérieures
- Toutes les plaques sont remplaçables individuellement
- Liberté de conception pour l'architecte
- Un éclairage LED peut être intégré sur une plaque extérieure perforée selon votre propre conception
- Durable dans le temps grâce aux matériaux utilisés et remplaçable facilement
- Construction circulaire : les pièces peuvent être recyclées séparément
- Possibilité d'utiliser des matériaux de façade autres que les plaques aluminium thermolaquées
- Imitation bois identique aux fenêtres PVC, miroir, cuivre, laiton, bois brûlé, céramique, pierre naturelle, verdure de façade, panneaux solaires, etc...

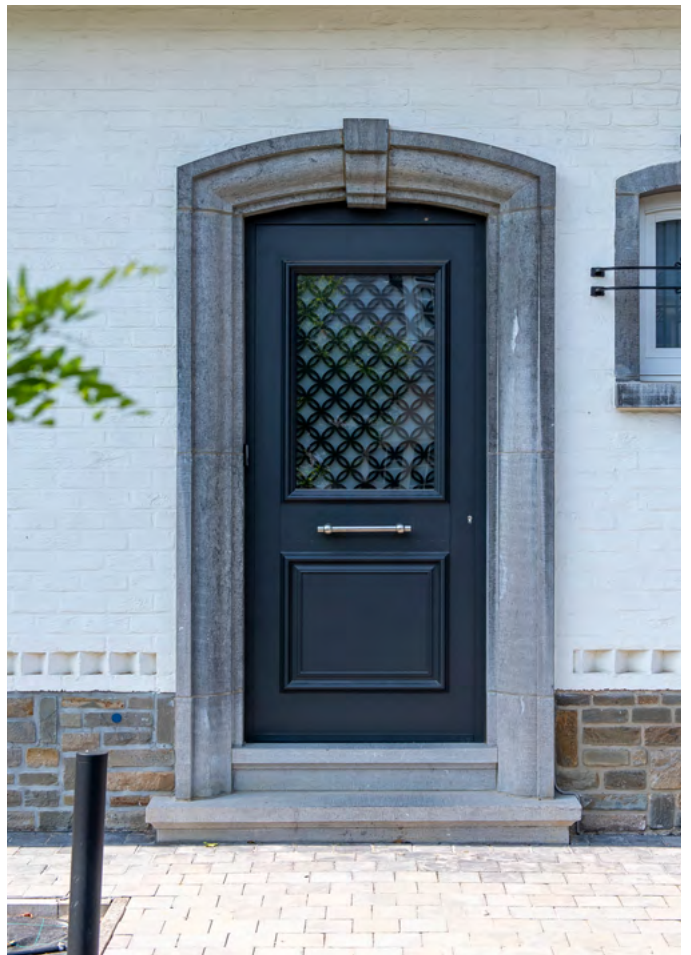

 NL



 FR



DE VOORDELEN

LES AVANTAGES

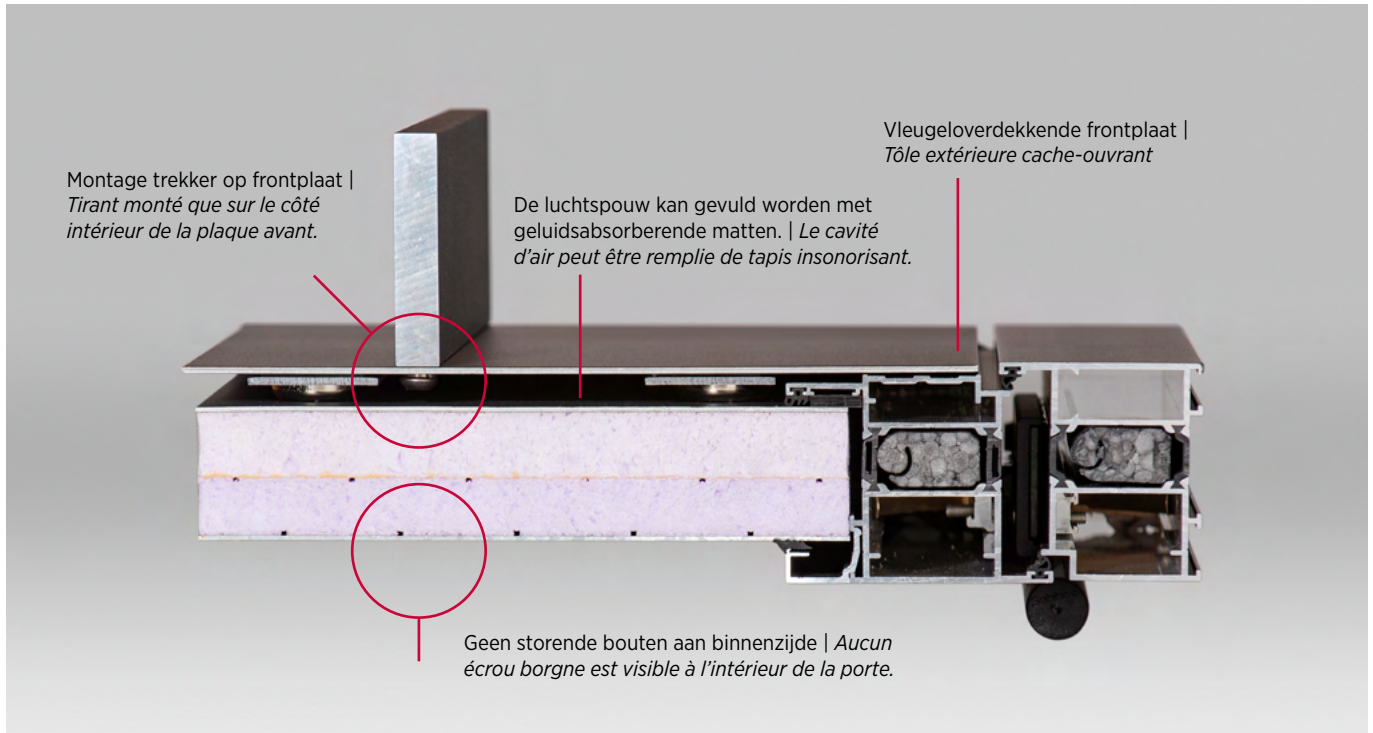

Geen kromtrekking

Een gelijkmd vleugeloverdekkend paneel kan de oorzaak zijn van kromtrekking. De buitenplaat van de deur zet uit en vervormt daarbij de opendraaiende vleugel. Het Magnetude-systeem laat de buitenplaat onafhankelijk van het profiel uitzetten. De doeltreffendheid hiervan werd niet alleen in de dagelijkse realiteit bewezen maar ook met testen bij een externe oppervlakte-temperatuur van 90°C. Verbluffend!

Pas de cintrage

Un panneau cache-ouvrant collé peut être la cause d'un cintrage. La plaque extérieure se dilate déformant ainsi l'ouvrant. Le système Magnetude permet alors à la tôle extérieure de se dilater indépendamment du profil. Son efficacité a été prouvée non seulement dans la réalité quotidienne mais également avec des tests effectués à une température de surface extérieure à 90°C. Impressionnant !

Schade? Geen probleem!

Magnetude biedt het voordeel dat het vulpaneel als voorlopig paneel kan worden geplaatst. De frontplaat kan de dag van de oplevering eenvoudig gemonteerd worden door 1 persoon zonder gereedschap!

Dégâts ? Aucun problème !

La porte d'entrée est trop souvent endommagée entre la pose et la réception des travaux. Ceci implique la plupart du temps le remplacement de la porte d'entrée. Le système Magnetude offre l'avantage que le panneau de remplissage peut être utilisé comme panneau temporaire. La plaque avant peut alors être facilement montée le jour de la livraison par 1 personne sans outils ! Même si des dommages surviennent par la suite, tous les éléments (même le vitrage !) peuvent être facilement remplacés à tout moment. Un nouvel ouvrant ne devra jamais être refait...



Onzichtbare montage deurtrekkers

Deurtrekkers worden onzichtbaar gemonteerd doordat ze enkel op de binnenkant van de frontplaat worden vastgezet. Hierdoor zijn er geen storende bouten zichtbaar aan de binnenzijde van deur. Door de trekkers op deze manier te monteren is er ook geen verbinding tussen het voorvel en het achtervel, waardoor condens op de binnenkant maar vooral ook de kromtrekking van de deur vermeden wordt.

Thermische isolatie

Een Magnetude-paneel isoleert merkkelijk beter dan traditionele panelen. Een deur met een U-waarde die een stuk lager ligt dan 1.0 W/m²K is makkelijk te realiseren in Magnetude. De thermische isolatie wordt namelijk bepaald door de dikte van het sandwich-paneel, we raden aan om te opteren voor een zo dik mogelijk vulpaneel in combinatie met smalle glaslaten.

Inbraakwerendheid

Zelfs wanneer inbrekers erin zouden slagen de buitenplaat van 2,5 mm te verwijderen, dan nog wordt men geconfronteerd met een klassiek vulpaneel dat in de glassponning stevig vastzit met de glaslat. Op dat moment is de deur net zo inbraakwerend als een normale deur met een ingebouwd paneel.

LED-verlichting

Via de ruimte tussen de buitenplaat en het sandwichpaneel kunnen de voedingskabels voor LED-verlichting makkelijk via de scharnierkant met een kabeldoorvoer naar het vleugelprofiel getrokken worden. Daar kan dan met een passende transfo de aansluiting gebeuren. De esthetische mogelijkheden hiervan inspireerden ons tot volledig nieuwe reeksen: Presidential (p. 23) en Bauhaus (p. 35). Leds gecombineerd met trekkers zorgen voor subtiele lichtaccenten en zijn zo een absolute meerwaarde voor de woning.

Montage invisible des tirants

Les tirants sont montés de manière invisible car ceux-ci ne sont fixés que sur le côté intérieur de la plaque avant. Ceci signifie alors qu'aucun écrou borgne n'est visible à l'intérieur de la porte. En montant les tirants de cette manière, il n'y a pas non plus de connexion entre la tôle avant et la tôle arrière, de façon à éviter la condensation à l'intérieur mais surtout le cintrage de la porte.

Isolation thermique

Un panneau Magnetude isole nettement mieux que les panneaux traditionnels. Une porte avec une valeur U bien inférieure à 1.0 W/m²K est facile à réaliser avec le système Magnetude. L'isolation thermique est principalement déterminée par l'épaisseur du panneau sandwich, nous recommandons d'opter pour le panneau de remplissage le plus épais en combinaison avec des parclozes étroits.

Résistance aux cambriolages

Même si les cambrioleurs parviennent à retirer la plaque extérieure de 2,5 mm, ils seront toujours confrontés à un panneau de remplissage classique qui est fermement fixé dans la feuillure grâce à la parclose. A ce moment-là, la porte est tout aussi anti-effraction qu'une porte classique avec panneau intégré.

Eclairage LED

Via l'espace entre la plaque extérieure et le panneau sandwich, les câbles d'alimentation pour l'éclairage LED peuvent être facilement tirés à travers le côté de la charnière avec un passe-câble vers l'ouvrant. La connexion peut alors être effectuée avec un transformateur approprié. Les possibilités esthétiques nous ont alors inspiré une toute nouvelles séries: Presidential (p. 23) et Bauhaus (p. 35). Les points LED combinés avec les tirants fournissent des accents de lumière subtils et sont donc une valeur ajoutée absolue pour la maison.



Puntled | Points led

JOHNSON - MI531|2

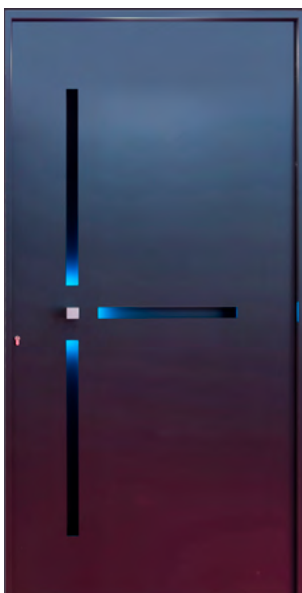

JEF - MI251|2



Led strip

BRANDT - BH021|2



MOHOLY - BH051|2





VERTICALE DOORSNEDE

COUPE VERTICALE

PVC - 1 ZIJDIG MAGNETUDE | MAGNETUDE 1 FACE

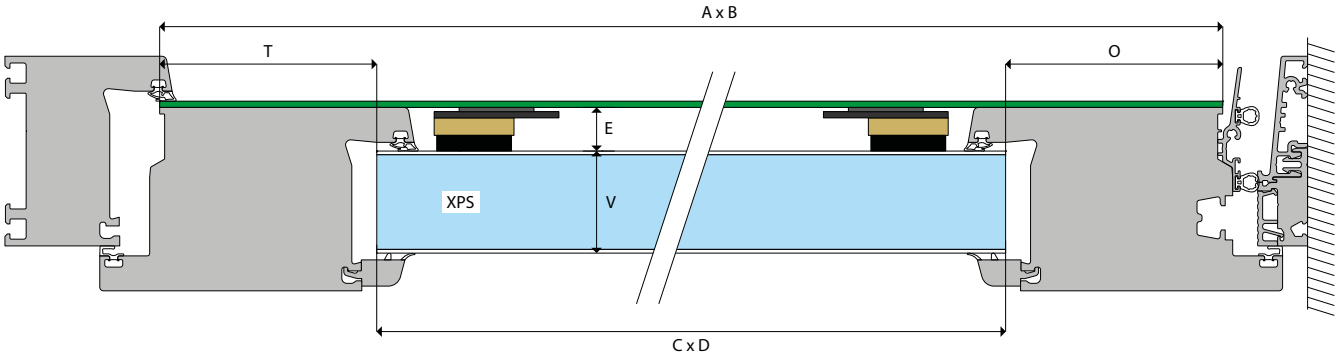

PVC - 2 ZIJDIG MAGNETUDE | MAGNETUDE 2 FACES

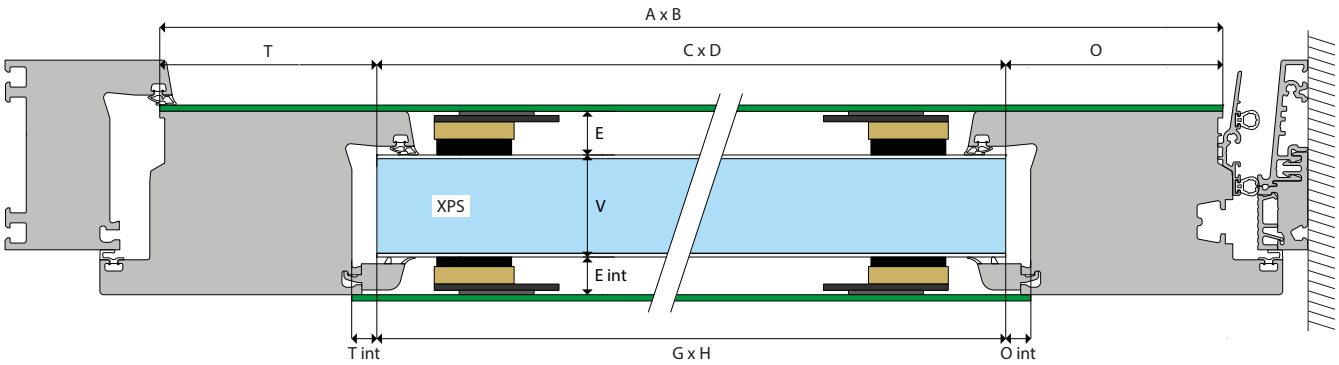

ALU - 1 ZIJDIG MAGNETUDE | MAGNETUDE 1 FACE

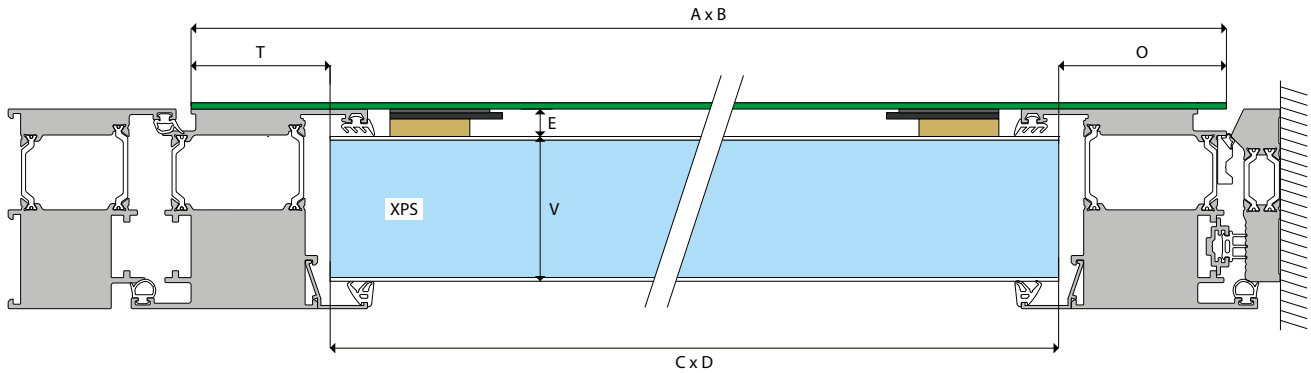

ALU - 2 ZIJDIG MAGNETUDE | MAGNETUDE 2 FACES

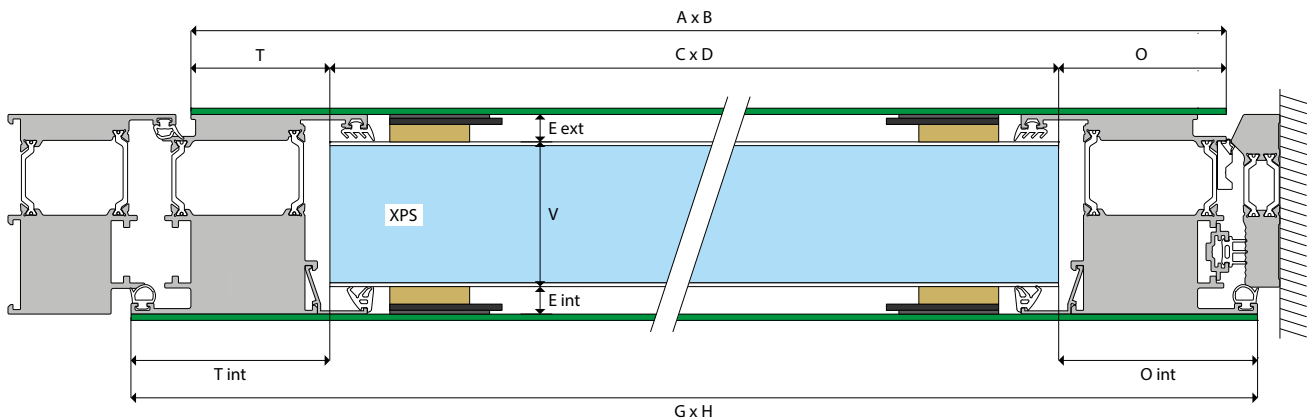

XPS SUPPLEMENTEN

Om alle profielkenmerken te kunnen bedienen, hebben wij XPS-kernen met 8 verschillende diktes in stock, nl. 11, 13, 16, 20, 25, 30, 33 en 40 mm.

Deze kunnen gecombineerd worden om andere diktes te verkrijgen. Voor de verlijming wordt € 55 aangerekend.

Vanaf 33 mm dikte wordt er tevens een supplement van € 1,5 per extra mm dikte/m² gerekend. Hieronder alvast een tabel met een aantal van de meest courante diktes :

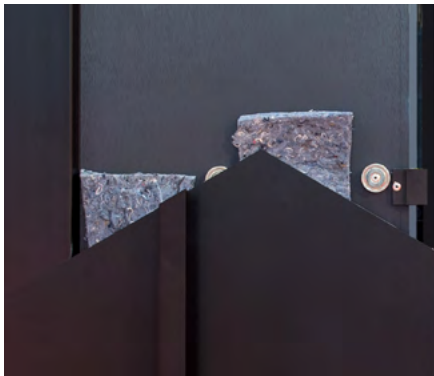

V	23 mm	28 mm	33 mm	36 mm	39 mm	43 mm	46 mm	53 mm
dikte kern - épaisseur âme	20 mm	25 mm	30 mm	33 mm	36 mm	40 mm	43 mm	50 mm
1000 x 2200	0	0	0	0	65	23	88	111
1150 x 2500	0	0	0	0	68	30	98	128
1250 x 2500	0	0	0	0	69	33	102	135
1150 x 3000	0	0	0	0	71	36	107	143
1500 x 3000	0	0	0	0	75	47	123	170

SUPPLÉMENTS XPS

Afin d'être compatible avec tous les profilés existants, nous avons des âmes XPS en 8 épaisseurs différentes en stock (11-13-16-20-25-30-33 et 40 mm).

Ces âmes peuvent être combinées pour obtenir des autres épaisseurs. Pour ce genre de collage une plus-value de 55 EUR brut est prise en compte. De plus pour toute épaisseur supérieure à 33 mm, une plus-value de 1,5 EUR brut par mm d'épaisseur supplémentaire s'applique. Pour les épaisseurs les plus courantes vous trouverez le tarif dans le tableau ci-dessous.

ACOUSTISCHE ISOLATIE: ACOUTEX

Voor Magnetude is optioneel een vulling beschikbaar die zorgt voor de demping van het omgevingsgeluid dat door de lucht wordt verspreid. Deze wordt in 3 banden geplaatst tussen het sandwichpaneel en de buitenplaat.

ISOLATION ACOUSTIQUE : ACOUTEX

Les panneaux Magnetude peuvent être prévus de tapis insonorisants pour absorber le bruit ambiant et qui réduit ainsi les nuisances sonores qui se propagent dans l'air. L' Acoutex est placé en 3 bandes entre le panneau sandwich et la tôle extérieure.

meerprijs per paneel

BRUTO **€ 305** BRUT

plus-value par panneau

GELIJKLIGGENDE BRIEVENBUS

In Magnetude-panelen is het voortaan ook mogelijk een subtiel ingewerkte briefplaat te krijgen die 100% gelijkliggend is met de frontplaat.

Deze wordt steeds geleverd met een keurig afgewerkte schacht en inox binnenklep.

BOÎTE AUX LETTRES AFFLEURANTE

Dans les panneaux Magnetude, il est désormais également possible d'obtenir une boîte aux lettres subtilement incorporée à 100% à fleur de la plaque avant.

Celle-ci est toujours livrée avec un conduit de liaison et le clapet inox intérieur.

meerprijs per paneel

BRUTO **€ 944** BRUT

plus-value par panneau

BRIEVENBUS OPENING

Indien een traditionele brievenbus gewenst is, kunnen hiervoor openingen in de voorplaat en het vulpaneel voorzien worden.

OUVERTURE DE LA BOÎTE AUX LETTRES

Si une boîte aux lettres traditionnelle est souhaitée, des ouvertures peuvent être prévues dans la plaque avant et le panneau de remplissage..

meerprijs per paneel

BRUTO **€ 225** BRUT

plus-value par panneau

BOORGATEN + MAGNETEN

Gepaste boorgaten en extra magneten kunnen aangebracht worden zodanig dat een trekker achteraf gemonteerd kan worden.

PERÇAGE DES TROUS + AIMANTS

Des perçages appropriés et des aimants supplémentaires peuvent être installés de manière à pouvoir poser un tirant ultérieurement.

meerprijs per paneel

BRUTO **€ 115** BRUT

plus-value par panneau

Acide
satimat - satinovo

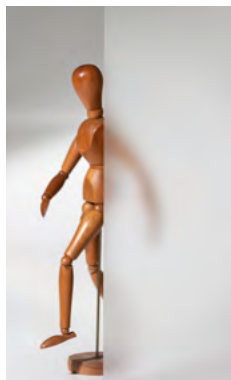

Std. Pos 2

Bamboo
klaar | clair

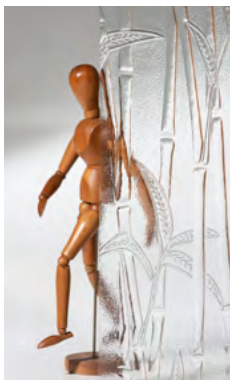

Std. Pos 3

SUPPL. + € 25*

Bamboo
mat



Std. Pos 3

SUPPL. + € 25*

Crepi
klaar | clair
(arena-granite 200)

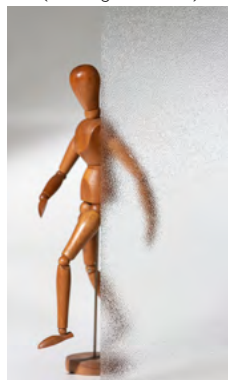

Std. Pos 3

Delta
klaar | clair



Std. Pos 3

SUPPL. + € 10*

Delta
mat

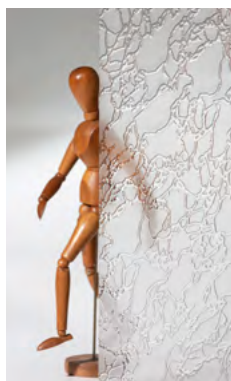

Std. Pos 3

SUPPL. + € 10*

Gothic
klaar | clair

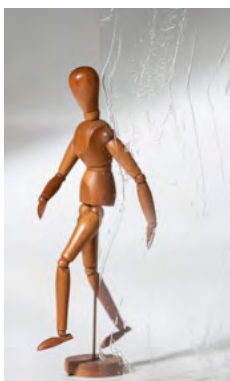

Std. Pos 3

Kathedraal min
Cathedral min

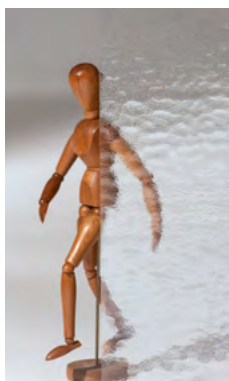

Std. Pos 3

Kathedraal max
Cathedral max

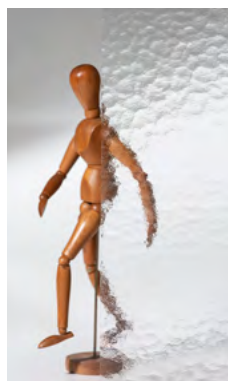

Std. Pos 3

Klaar
Clair

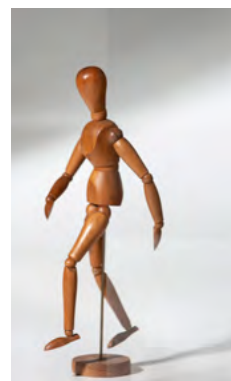

Niagara
klaar | clair



Std. Pos 3

SUPPL. + € 25*

Monumental / Ocean
klaar | clair



Std. Pos 3

Orchidee
klaar | clair



Std. Pos 3

Sablé
Sablé

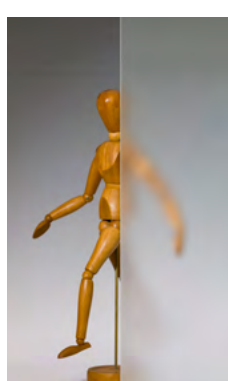

Std. Pos 2

Screen
Screen



Std. Pos 3

OVERZICHT GLASOPTIES | APERÇU DES VITRAGES

Silvit
klaar | clair



Std. Pos 3

Waterdrop
Goutte d'eau



Std. Pos 3

Antelio
klaar | clair

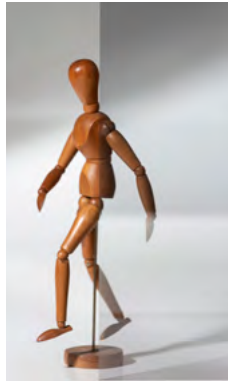

Std. Pos 2

SUPPL. + € 30*

Dark
glass

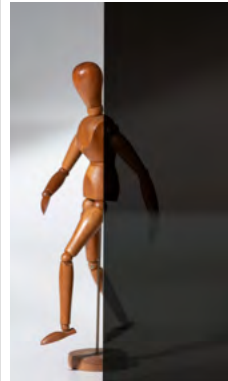

Std. Pos 2 + 3

SUPPL. + € 98*

<<< OPMERKING:

Dark glass: geen coating of gelaagd mogelijk bij dubbel glas Dark.

REMARQUE :

Dark glass : coating ou feuilleté pas possible en double vitrage Dark.

**NIEUW
NOUVEAU**

Sablé +
heldere boord/figuur |
bord clair/dessin

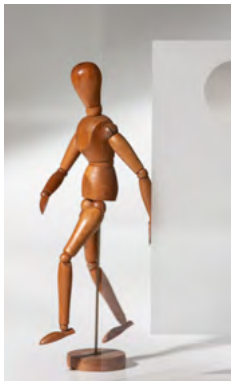

Std. Pos 2

SUPPL. afh. van model*
dépend du modèle

Sablé +
klaar cijfer | chiffre clair

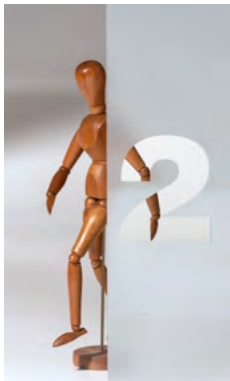

Std. Pos 2

SUPPL. + € 251*

Stopsol Classic
klaar | clair

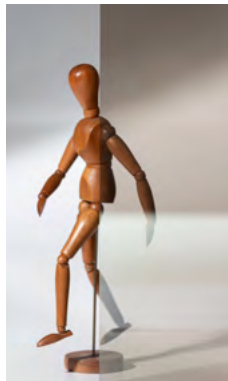

Std. Pos 2

SUPPL. + € 98*

Stopsol Supersilver
klaar | clair

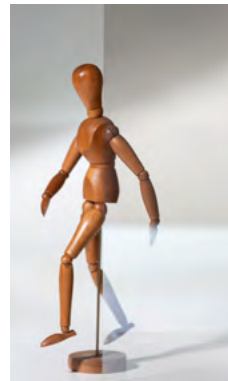

Std. Pos 2

SUPPL. + € 98*

Gelaagd 33.1 opaal
Feuilleté 33.1 opalin

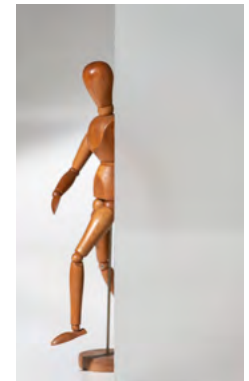

Std. Pos 2

SUPPL. afh. van model*
dépend du modèle

*SUPPLEMENT per glas - SUPPLÉMENT par volume vitré

GELAAGD - COATING FEUILLETÉ - COATING		Vanaf kerndikte Epaisseur mini+male de l'âme (mm)	■ Prij - Prix (d)	▼●●♣ Prij - Prix (d)
Gelaagd 33.1 - 33.2	Feuilleté 33.1 - 33.2	20	€ 55	€ 65
Opaal 33.1 - 33.2 (pvb mat)	Opalin 33.1 - 33.2 (pvb mat)	20	€ 55	€ 65
Gelaagd 44.2	Feuilleté 44.2	29	€ 79	€ 93
Gelaagd 44.6 (SP10)	Feuilleté 44.6 (SP10)	29	€ 105	€ 124
Coating	Coating	20	€ 48	€ 48
Coating + gas	Coating + gaz	20	€ 109	€ 109
Coating (a) - min. 1.1 W/m2 K	Coating (a) - min. 1.1 W/m2 K	33	€ 0	€ 0
Coating + gas (a) - min 1.0 W/m2 K	Coating + gaz (a) - min 1.0 W/m2 K	33	€ 53	€ 53

Vorm	Naam	Nom	3 dubbel glas triple vitrage	Sablé met klare boord Sablé avec bord clair	Warm Edge (c)
■	Rechthoekig / vierkant	Rectangulaire / Carré	€ 59	€ 69 (b)	€ 24
▼	Driehoekig	Triangulaire	€ 78	€ 108	-
◐	Halve boog	Demi-lune	€ 102	€ 108	-
●	Cirkelvormig	Cercle	€ 156	€ 108	-
♣	Andere	Autre	€ 204	€ 108	-

(a) Waarden geldig voor standaard kern Thermimax 33 | Valeurs valables avec âme standard Thermimax 33

(b) Indien klare boord rechthoekig is | Si bord clair rectangulaire

(c) Prijs per spouw, dus 2x voor driedubbel glas en 3x voor vierdubbel glas | Prix par intercalaire, alors 2x pour triple vitrage et 3x pour vitrage quadruple

(d) Prijs voor dubbel gelaagd = x2, dus € 110 voor ■ | Prix pour feuilleté deux faces = x2, donc € 110 pour ■

LOODGLAS | VITRAIL

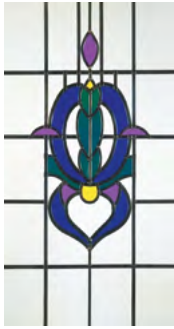

Elegance - Petra

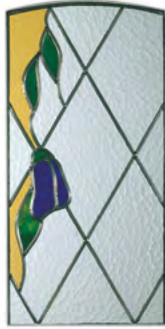

Royal - Tina



Chateau - Sofia



Tina



Maxima - Pavera

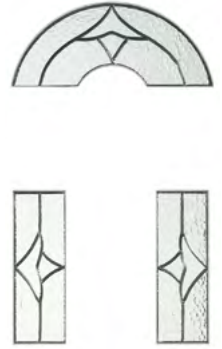

Eva



Wenen

Wenen - Azura

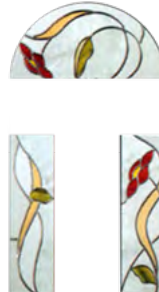

Venetië

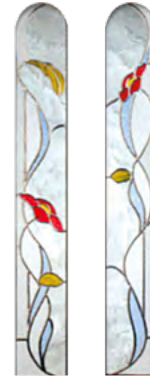

Madrid



Praag



Wenen



Wenen



York



Venetië



Atlanta - Parijs

SABLÉ + FIGUUR | SABLÉ + DESSIN



Elegance - Petra
Tina



Maxima - Pavera
Royal - Tina



Ambassade - Mathilda -
Matteo - Sofia - Chateau



Chateau - Petra - Royal
Sofia - Elegance - Tina

OVERZICHT SIERGLAZEN | APERÇU DES VITRAGES DECORATIFS

DECOGLAS | VITRAGE DÉCO



Elegance - Petra



Elegance - Petra



Paola - Monza

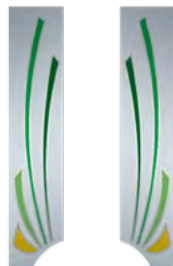

Paola - Monza



Tina - Royal



Tina - Royal



Chateau - Sofia



Chateau - Sofia



Ambassade
Mathilda - Matteo



Ambassade
Mathilda - Matteo



Elena - Mira



Elena - Mira



Maxima - Pavera



Maxima - Pavera



Luca



Luca



Luca - Mono



Luca - Mono



Nevada



Nevada



Nikita - Ria



Nikita - Ria



Eva



Eva



Debora - Flandria - Lord
Taste - Cadens - Ritmo



Narcis - Narca

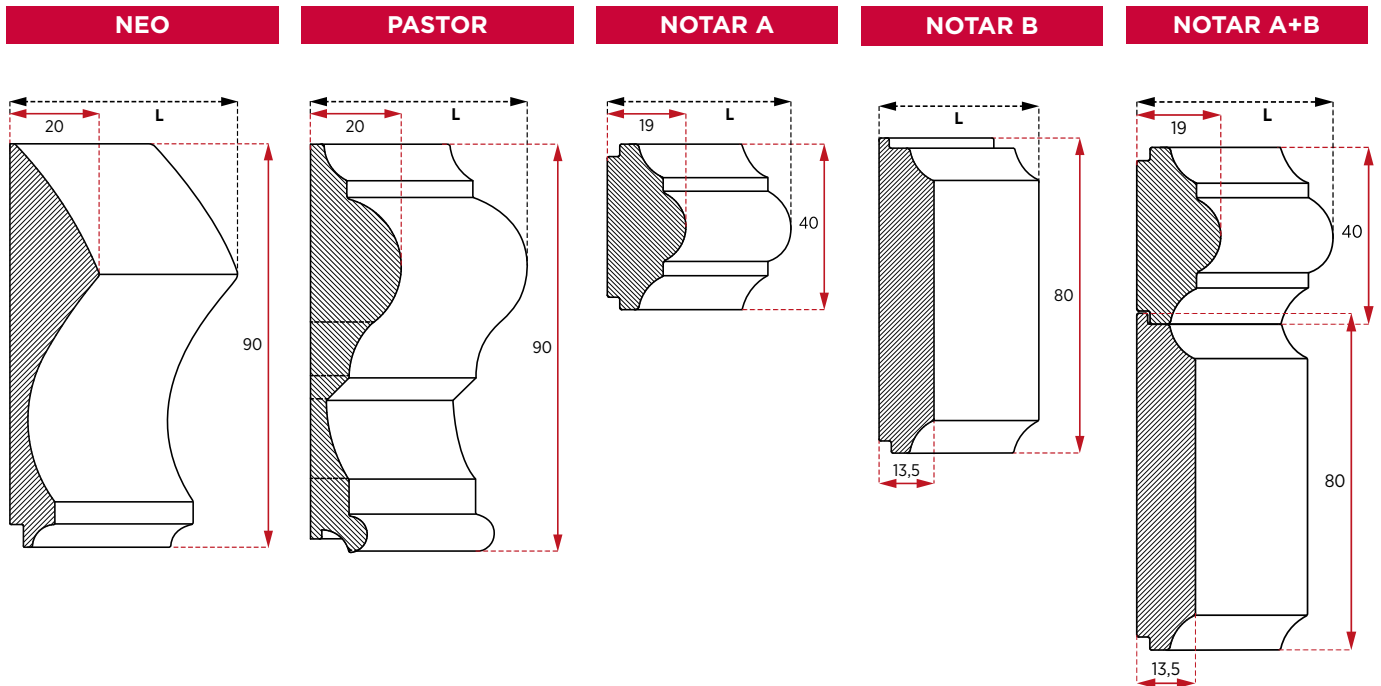

KRUISKOZIJNEN (KK) | PETITS BOIS INTEGRES (PBI)

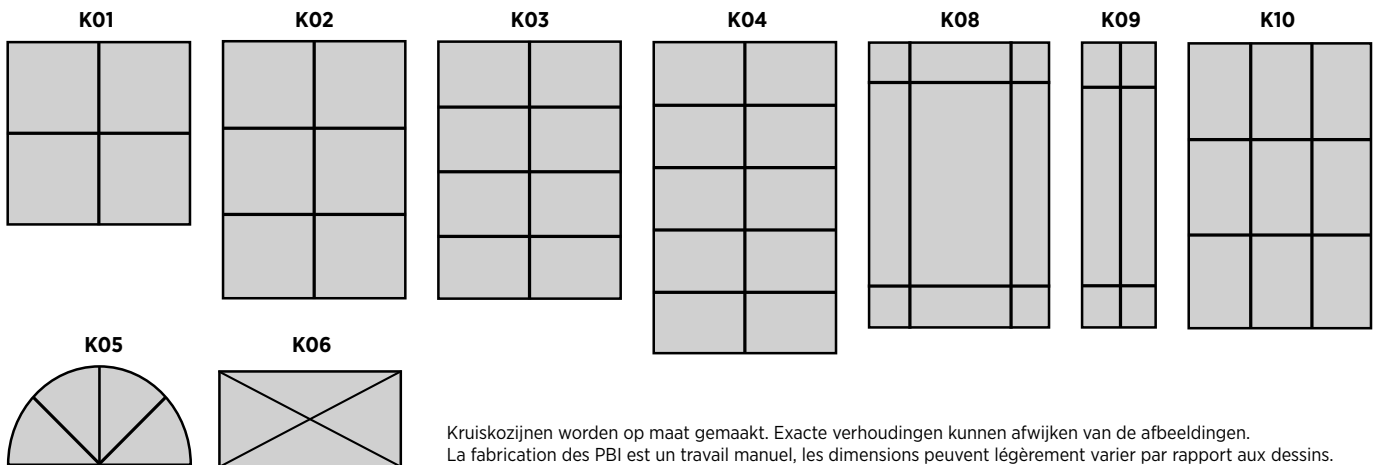

Afwerking Finition	Breedte Largeur	K01	K02	K03	K04	K05	K06	K08	K09	K10
Wit - Blanc	18 mm	65	134	171	208	179	134	177	134	208
Koper - Laiton	8 mm	65	134	171	208	179	134	-	134	208
Loodkleurig - Couleur plomb	8 mm	65	134	171	208	179	134	-	134	208
Folie unicolor - Filmé unicolor*	18 mm	131	269	342	416	357	269	357	269	416
Folie bicolor - Filmé bicolor*	18 mm	197	400	510	622	535	400	535	400	622
RAL unicolor	18 mm	131	269	342	416	357	269	357	269	416
RAL bicolor	26 mm	197	400	510	622	535	400	535	400	622

* Folie maar in beperkt aantal kleuren beschikbaar (zie website) | Filmé limité à une sélection de couleurs (voir site internet)

MU 20

Zolang de voorraad strekt
Jusqu'à l'épuisement des stocks



HDP 25

Zolang de voorraad strekt
Jusqu'à l'épuisement des stocks



THERMIMAX - ISOL+

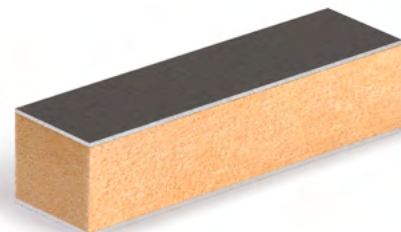

FLAMEBOARD

Enkel voor alu schrijnwerk
Seulement pour menuiserie alu



ISOMIX 37/40/43



AMAC 38

Enkel onbeglaasd | Uniquement non-vitré



Informatie | Information

Kernen Ames	MU 20	ISOL + 22	HDP 25	THERMI-MAX 33	FLAME-BOARD 200 +	ISOMIX 37	AMAC 38	ISOMIX 40	ISOMIX 43
Totale dikte Epaisseur totale ALU/PVC	23/24	26/27	27/28	36/37	38/39	40/41	41/42	43/44	46/47
U-waarde Valeur U W/m ² K	3,21	1,5	1,71	1,1	1,3	0,53	2,38	0,51	0,49
RW-dB Geluidswerend, enkel onbeglaasd Acoustique, uniquement non-vitré		26		30		28	41	28	28
Rf-EI Brandwerend, enkel onbeglaasd Coupe feu, uniquement non-vitré					30				

stand.

XPS



Kernen • Ames	XPS 20	XPS 25	XPS 30	XPS 33	XPS 40	XPS 50
Totale dikte • Epaisseur totale ALU/PVC	23/24	28/29	33/34	36/37	43/44	53/54
U-waarde • Valeur U W/m ² K	1,10	0,91	0,78	0,72	0,61	0,49

ALUFIX

zie|voir p. 135

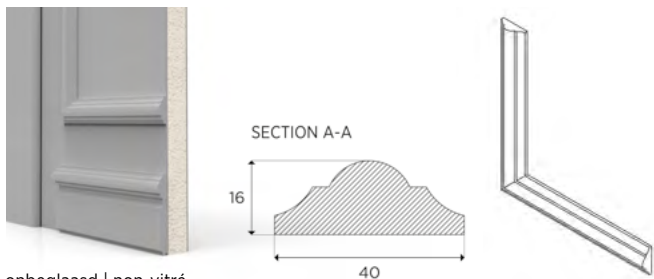

onbeglaasd | non-vitré

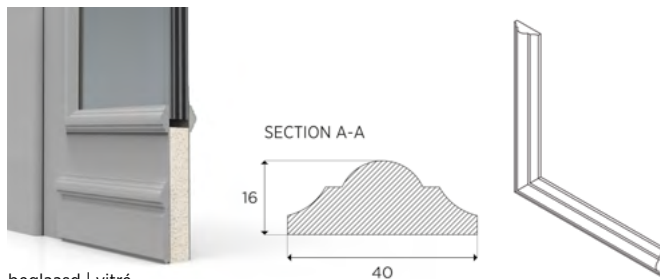

beglaasd | vitré

EXPANSION

zie|voir p. 118

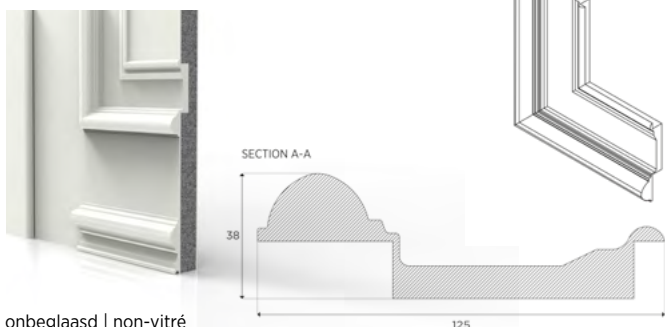

onbeglaasd | non-vitré

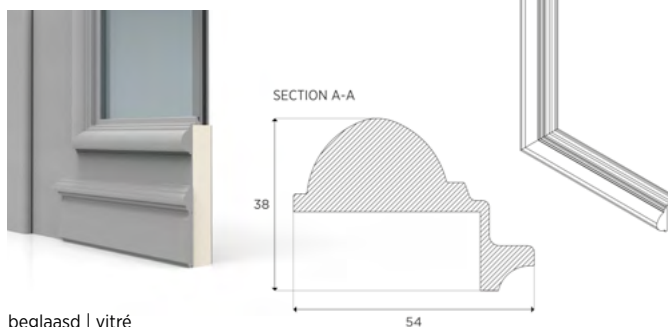

beglaasd | vitré

PROGRESS

zie|voir p. 125

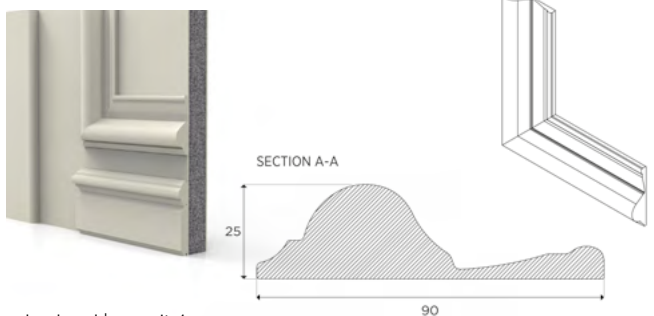

onbeglaasd | non-vitré

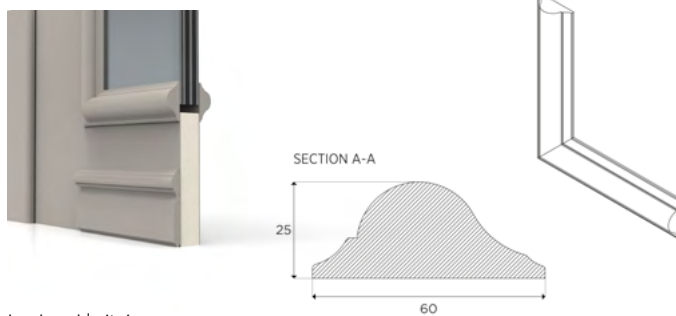

beglaasd | vitré

INFREZING | FRAISAGE

LIGHT DESIGN

zie | voir p. 73

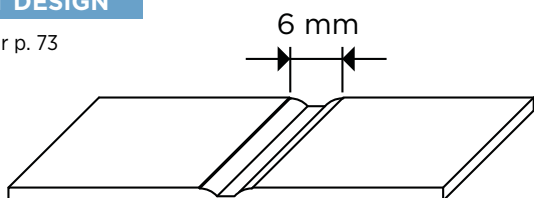

TYPE I

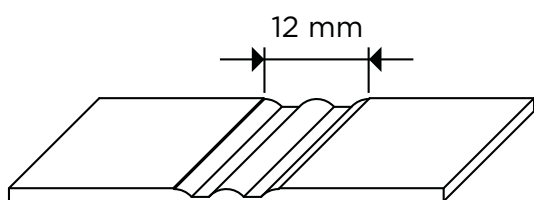

TYPE II

MONDIAL

zie | voir p. 85

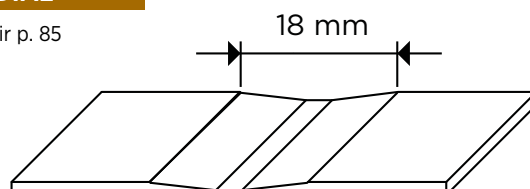

TYPE III

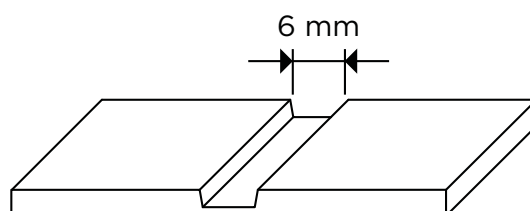

TYPE IV

IV [6, 8, 10, 12, 14, 16, 18, 20]

VERZAGEN OP MAAT

Optioneel kunnen sierpanelen door ons op maat worden gezaagd. Als basisprincipe hanteren we steeds een symmetrische verzaging, enkel wanneer het model dit niet toelaat wordt er van dit principe afgeweken.

KADERS IN AFWIJKENDE KLEUR

In de reeksen Alufix en Progress kan er ook gekozen worden voor kaders in een afwijkende kleur. Dit zorgt voor een mooi extra contrast en zeker bij panelen in houtstructuur gecombineerd met bvb. zwarte kaders wordt er zo een unieke, hedendaagse look gecreëerd.

BOUTEN GELAKT IN KLEUR PANEEL

De bevestigingsbouten voor deurbeslag kunnen voor een nog strakkere afwerking optioneel ook gespoten worden in de kleur van het paneel zelf.

TREKKERS IN EEN KLEUR NAAR KEUZE

In de Minimal en Bauhaus-reeks worden de trekkers standaard gelakt in hetzelfde kleur als de frontplaat zelf. Tegen meerprijs kan deze greep echter ook in een accentkleur naar keuze worden gelakt. Personalisering ten top!

NERVEN IN ANDERE KLEUR (INDIEN POEDERLAK)

Traditioneel worden nerven (Light Design en Mondial) in dezelfde kleur gelakt als het paneel. Het is nu ook mogelijk om de nerven in een andere kleur te lakken.

AFWERKING FOLIE/RAL POEDER

Voor aluminiumschrijnwerk is het ook mogelijk om te opteren voor de afwerking folie/RAL poeder naast de andere afwerkingmogelijkheden. Bv. als houtimitatie gewenst is aan frontplaat, maar de achterzijde bijpassend is aan het schijnwerk.

DÉCOUPE À DIMENSIONS

€ 60

En option, les panneaux décoratifs peuvent être découpés sur mesure par nos soins pour une plus-value de 60€ brut. Nous appliquons toujours le principe de la découpe symétrique sauf lorsque le modèle ne le permet pas.

CADRES DANS UNE COULEUR DIFFÉRENTE

€ 255

Dans les séries Alufix et Progress, il est désormais possible d'opter pour des cadres d'une couleur différente. Ceci permet alors un contraste supplémentaire, en particulier avec des panneaux en structure bois combinés avec, par exemple des cadres noirs, un look contemporain unique est alors créé.

VIS DE FIXATION LAQUÉES DANS LA COULEUR DU PANNEAU

€ 97

Les vis de fixation des tirants peuvent optionnellement être laquées dans la couleur du panneau lui-même pour une finition en-core plus épurée.

TIRANTS INTÉGRÉS DANS UNE COULEUR DIFFÉRENTE.

€ 255

Dans la série Minimal et Bauhaus, en standard les tirants encastrés sont laqués de la même couleur que la plaque avant. Moyennant un supplément, cette poignée peut cependant également être laquée d'une couleur de votre choix, une personnalisation au top.

RAINURES DANS UNE AUTRE COULEUR (SI THERMOLAQUAGE)

€ 295

Traditionnellement, les rainures (Light Design et Mondial) sont laqués de la même couleur que le panneau. Il est désormais également possible de peindre les rainures d'une couleur différente.

FINITION FILMÉ/THERMOLAQUÉ

€ 145

Pour menuiseries alu, il est en dehors des autres finitions également possible d'opter pour la finition filmé/thermolaqué. Ceci est p.e. le cas si vous souhaitez une imitation bois extérieur et que la couleur intérieure doit être adapté aux menuiseries couleur.



NEW! GESPIEGELDE VARIANT | IMAGE INVERSE

(5) VB. | P. EX.

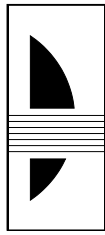

Gespiegelde variant mogelijk
Image inverse possible

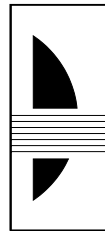

Bestellen: laatste cijfer te vervangen door rode cijfer na het rode streepje

Pour commander : remplacer le dernier chiffre par le chiffre rouge après la petite ligne rouge

frager.
CREATORS OF DOORS

light design

M1 1 ZIJDE MOTIEF MOTIF 1 FACE M2 2 ZIJDEN MOTIEF MOTIF 2 FACES	PVC wit blanc • beige crème • 120 140 150	EXT folie filmé • INT wit blanc • beige crème	EXT folie filmé • INT folie filmé	RAL poeder p. 172-174	RAL pistool pistoleet	SUPPL. (2) magnetude		opties glas options vitrage p. 12-13				
						1 (1) ZIJDE FACE p. 7-11	2 ZIJDEN FACES p. 7-11	glas vormen • forme du vitrage	gelaagd 33.2 • feuilleté 33.2	sablé met klare boord • sablé avec bord clair	coating 1,1 met kern ISOL+, MU20 of HDP25 • avec âme ISOL+, MU20 ou HDP25	
▼ buitenaanzicht vue extérieure	900x2100x37 mm	900x2100x36 mm	900x2100x36 mm	900x2100x36 mm	900x2100x36 mm	990x2190 mm	≤ 990x2190 mm					
NEW YORK LD011 (3)	M1	579	936	1009	1116	1296	+463	+1196				
901 (2) 128	M2	690	1281	1281	1228	1420	+463	+1196				
AMSTERDAM LD021 (4)	M1	579	936	1009	1116	1296	+463	+1196				
902 (2) 200	M2	690	1281	1281	1228	1420	+463	+1196				
KOBE LD041 2 (5) 92120	M1	1181	1505	1580	1705	1867	+715	+2228	2 x (8)	+130	+216	(9)
514 x 1660mm	M2	1297	1858	1858	1835	1997	+846	+2228	SG p. 84 KK p. 84			

**GEKLEURDE RAND
CONTOUR COLORÉ**

maatwerk | sur mesure

zie | voir
FRAGER WEBSHOP

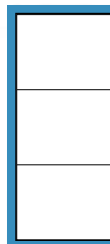

FALCON LD241

LD DESIGN A

I

naam | nom

bestelnr. | n°de commande

oude naam & nr. | ancien nom & n°

infrezingstype
type de fraisage

altijd|toujours
p. 18

	ext. int.
M1	1 zijde motief Motif 1 face
M2	2 zijden motief Motif 2 faces

(1) **1 ZIJDE | FACE**
2 ZIJDEN | FACES
magnetude
altijd | toujours
p. 5

(2) **1 ZIJDE | FACE**
magnetude

Gelijmde opdekpanelen mogelijk*:
meerprijs bovenop het **magnetude**
supplement | **Les panneaux cache-**
ouvrant collés possibles : **plus-value**
sur le supplément **magnetude**

* enkel bij onbeglasde panelen | unique-
ment avec des panneaux non vitrés

+ € 375

(3) **Asmaten verticaal**
Entraxes verticales

(3) **Asmaten horizontaal**
Entraxes horizontales

(5) **Gespiegelde variant mogelijk**
Image inverse possible

(6) **Minimum zaagmaat voor IN-**
BOUW | Découpe minimum
pour POSE EN FEUILLURE

(7) **SG p. 61** Special glas
Vitrages decoratifs

(7) **KK p. 60** Kruiskoziijnen (KK)
Petits bois intégrés (pbi) **p. 60**

(8) **3 x** SUPPLEM.
Glasvormen
Formes du vitrage
altijd | toujours
p. 13

(9) enkel meerprijs met kern
isol+ / thermi+
plus value seulement avec âme
isol+ / thermi+



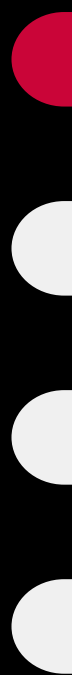

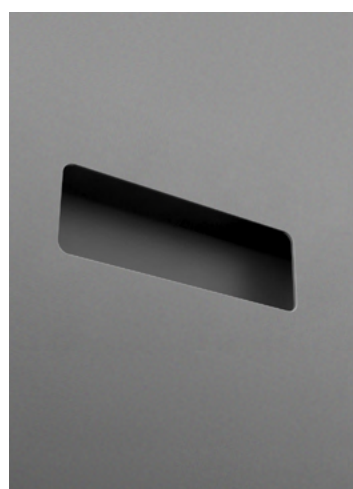
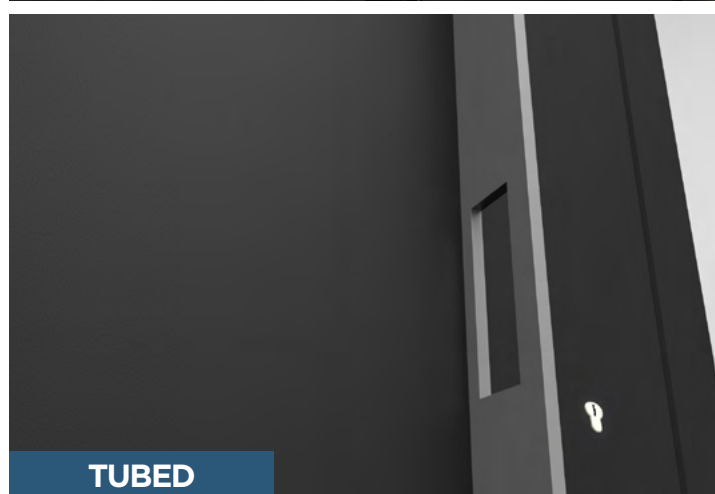



m modern

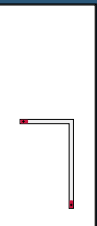

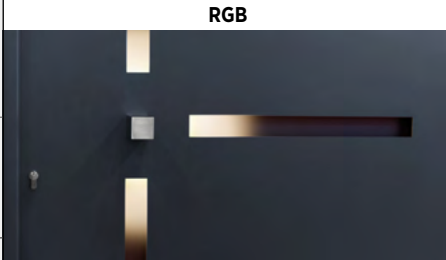
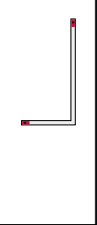

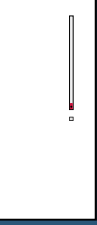
Supplementen | Suppléments

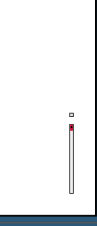
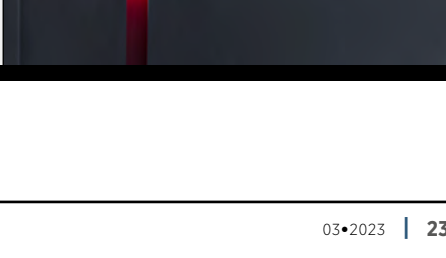
magnetude	1 ZIJDE FACE					2 ZIJDEN FACES				
	PVC	1Z folie filmé	2Z folie filmé	RAL poeder poudre	RAL pistool pistolet	PVC	1Z folie filmé	2Z folie filmé	RAL poeder poudre	RAL pistool pistolet
Formaat • Format										
990 x 2190	0	0	0	0	0	0	0	0	0	0
1240 x 2490	272	-	-	272	272	427	-	-	427	427
1140 x 2490	-	272	272	-	-	-	427	427	-	-
1140 x 2990	-	836	836	-	-	-	1226	1226	-	-
1490 x 2990	543	-	-	543	543	851	-	-	851	851

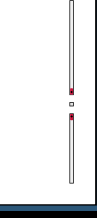
ENKEL MAGNETUDE • D'OFFICE MAGNETUDE standaard ft standard 990 x 2190		VLEUGELOVERDEKKEND CACHE-OUVRANT magnetude							info	
		PVC wit blanc • beige crème • 120 140 150	EXT folie filmé • INT wit blanc • beige crème	EXT folie filmé • INT folie filmé	RAL poeder poudre p. 172-174	RAL pistool pistolet	2 ZIJDEN FACES p. 7-11		Punt LED point	koud wit blanc froid
	TRUMAN MI601 2 JEFFRA 1	M1	2002	2002	2002	2002	2238	+832	wit blanc +840 RGB +1052	
	M2									
	BUCHANAN MI611 2 JEFFRA 2	M1	2002	2002	2002	2002	2238	+832	wit blanc +840 RGB +1052	
	M2									
	HARRISON MI621 2 JEFFERSON 1	M1	1955	1955	1955	1955	2191	+832	wit blanc +420 RGB +526	
	M2									
	JACKSON MI631 2 JEFFERSON 2	M1	1955	1955	1955	1955	2191	+832	wit blanc +420 RGB +526	
	M2									
	WILSON MI641 2 JEFFERSON 3	M1	1955	1955	1955	1955	2191	+832	wit blanc +420 RGB +526	
	M2									
	NIXON MI501 2 JEFFERSON 12	M1	2367	2367	2367	2367	2603	+832	wit blanc +840 RGB +1052	
	M2									

Indicatif: afhankelijk van de afmetingen A, B, C, D. | Indicatif : dépend des dimensions A, B, C, D.

• **Presidential:** Enkel mogelijk als E + V ≥ 40 mm | Seulement possible quand E + V ≥ 40 mm (zie | voir p. 10)

 Positie punt LED | position LED point

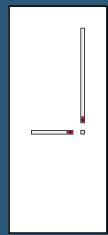
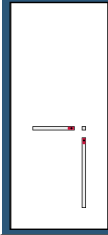
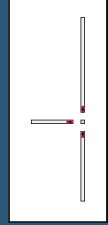
ENKEL MAGNETUDE • D'OFFICE MAGNETUDE standaard ft standard 990 x 2190		VLEUGELOVERDEKKEND CACHE-OUVRANT magnetude						2 ZIJDEN FACES	Punt LED point
		PVC wit blanc • beige crème • 120 140 150	EXT folie filmé • INT wit blanc • beige crème	EXT folie filmé • INT folie filmé	RAL poeder poudre	RAL pistool pistolet			
▼ buitenaanzicht vue extérieure					p. 172-174		p. 7-11		
 <p>LINCOLN MI511 2 JEFFERSON 13</p> <p>540 x 540mm</p>	M1	2367	2367	2367	2367	2603	+832	wit blanc +840 RGB +1052	
	M2								
 <p>WASHINGTON MI521 2 JEFFERSON 23</p> <p>540 x 540mm</p>	M1	2367	2367	2367	2367	2603	+832	wit blanc +840 RGB +1052	
	M2								
 <p>JOHNSON MI531 2 JEFFERSON 123</p> <p>540 x 540mm</p>	M1	2838	2838	2838	2838	3074	+832	wit blanc +1260 RGB +1579	
	M2								

info

JOHNSON



trekker | tirant



PRESIDENTIAL is verkrijgbaar met 6 verschillende subtiele LED-accenten. Het voorvel wordt voorzien van een 3 Watt LED-armatuur (puntled). De bekabeling loopt tussen het voorvel en het vulpaneel. De transfo met output van 12 of 24 V is hierbij niet inbegrepen.

PRESIDENTIAL est disponible avec 6 accents LED subtiles différentes. La tôle extérieure est prévue d'un luminaire LED 3 Watt (led point). Le câblage pass entre la tôle extérieure et le panneau de remplissage. Le transfo de 12 ou 24 V n'est pas inclus.

inox

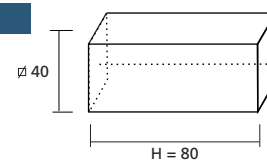

Lakken in het kleur van het paneel
Laquage dans la couleur du panneau **+ € 225**



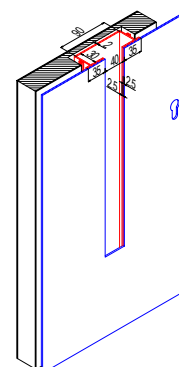

Inliggende trekker STANDAARD in kleur paneel
Tirant intégré STANDARD en couleur du panneau

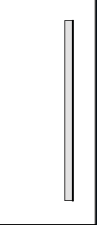

Indicatif: afhankelijk van de afmetingen A, B, C, D. | Indicatif : dépend des dimensions A, B, C, D.

• **Presidential:** Enkel mogelijk als E + V ≥ 40 mm | Seulement possible quand E + V ≥ 40 mm (zie | voir p. 10)

Positie punt LED | position LED point

STANDAARD MAGNETUDE • D'OFFICE EN MAGNETUDE standaard ft standard 990 x 2190		VLEUGELOVERDEKKEND CACHE-OUVRANT magnetude						Punt LED point	
		PVC wit blanc • beige crème • 120 140 150	EXT folie filmé • INT wit blanc • beige crème	EXT folie filmé • INT folie filmé	RAL poeder poudre p. 172-174	RAL pistool pistolet	2 ZIJDEN FACES p. 7-11		
	OSCAR MI181 2 3D OSCAR	M1	2570			2570	3877	+1107	
	M2	Paneel en trekker hebben dezelfde kleur Panneau et tirrant ont la même couleur							
	JUUL MI191 2 3D JUUL	M1	2510	2510	2510	2510	3769	+832	
	M2								
	LEON MI201 2 3D LEON	M1	2570	2570	2570	2570	3877	+1107	
	M2	E + V ≥ 48 mm							
	BASIL MI231 2 3D BASIL	M1	1590	1590	1590	1590	1826	+832	wit blanc +420 RGB +526
	M2								
	MODEST MI261 2 3D MODEST	M1	1644	1644	1644	1644	1888	+832	
	M2								
	JEF MI251 2 3D JEF	M1	1590	1590	1590	1590	1826	+832	wit blanc +420 RGB +526
	M2								

Indicatif: afhankelijk van de afmetingen A, B, C, D. | Indicatif: dépend des dimensions A, B, C, D.

• Dimensional: E + V ≥ 40 mm (zie/voir p. 10)

info

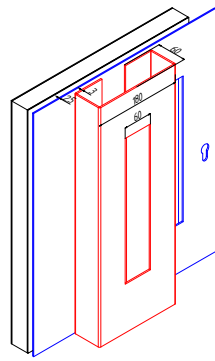

OSCAR

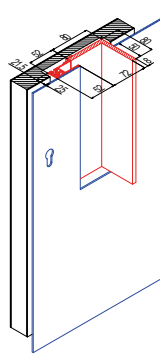

JUUL

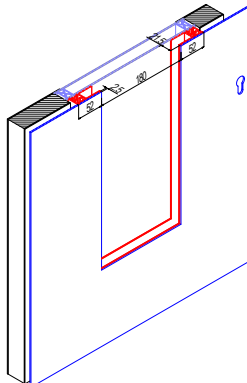

LEON



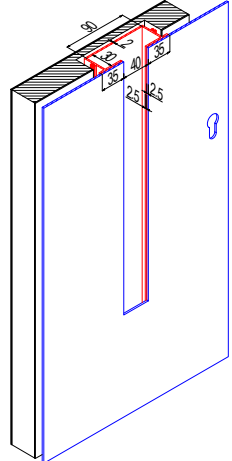

JEF | BASIL

trekker | tirant Jef

MODEST

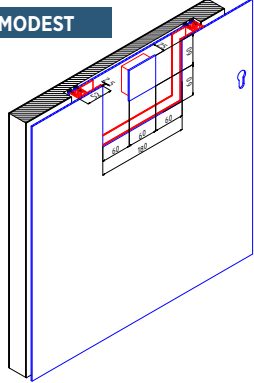

STANDAARD MAGNETUDE • D'OFFICE EN MAGNETUDE standaard ft standard 990 x 2190		VLEUGELOVERDEKKEND CACHE-OUVRANT magnetude						Punt LED point	
		PVC wit blanc • beige crème • 120 140 150	EXT folie filmé • INT wit blanc • beige crème	EXT folie filmé • INT folie filmé	RAL poeder poudre p. 172-174	RAL pistool pistolet	2 ZIJDEN FACES p. 7-11		
 <p>LOU MI671 2</p> <p>540 x 540mm</p>	M1	2570	2570	2570	2570	3877	+1107	wit/blanc +420 RGB +526	
	M2								
	M1								
	M2								
	M1								
	M2								
	M1								
	M2								
	M1								
	M2								

info

LOU

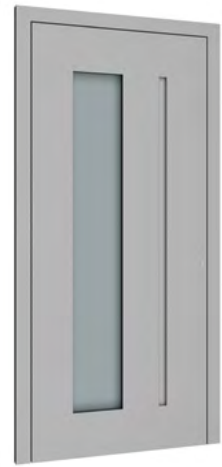

Indicatif: afhankelijk van de afmetingen A, B, C, D. | Indicatif : dépend des dimensions A, B, C, D.

• **Dimensional:** E + V ≥ 40 mm (zie|voir p. 10)

*** TOT ONZE SPIJT ZIJN WE GENOODZAAKT ONZE ARBRAS MINIMAL SERIE TE SCHRAPPEN UIT ONS AANBOD.**

Dit is het gevolg van toeleveringsproblemen van het eikenhout dat we voor deze serie gebruiken. De kwaliteit van het geleverde hout haalt niet de gewenste esthetische norm. Daardoor zijn we genoodzaakt dit type deuren niet meer aan te bieden.

Als alternatief bieden we de mogelijkheid om te kiezen uit enkele acrylaatfolies met een uitzonderlijke houtlook imitatie. Gecombineerd met LIGHT DESIGN type 1 infrezingen (zwart of kleur passend bij de houtimitatie) biedt dit een perfect alternatief voor de ARBRAS SERIE.

Concreet gaat het over de folies Woodec: Turner Oak Toffee, Sheffield Oak Alpine, Sheffield Oak Concrete en Turner Oak Malt.

CONTACTEER ONS GERUST VOOR BIJKOMENDE INFO OF STALEN!

*** A NOTRE GRAND REGRET, NOUS SOMMES CONTRAINTS DE RETIRER NOTRE SERIE ABRAS MINIMAL DE NOTRE GAMME.**

Ceci vient en grande partie à cause des problèmes d'approvisionnement du chêne que nous utilisons pour cette série. La qualité du bois fourni ne correspond pas aux exigences souhaitées. De ce fait, nous sommes contraints de ne plus proposer ce type de portes.

Comme alternative, nous offrons la possibilité de choisir parmi quelques films acryliques avec une imitation bois exceptionnelle. Combiné au fraisage LIGHT DESIGN type 1 (noir ou couleur assortie à l'imitation bois), il offre une parfaite alternative à la SERIE ABRAS.

Plus précisément, cela concerne les films Woodec : Turner Oak Toffee, Sheffield Oak Alpine, Sheffield Oak Concrete et Turner Oak Malt.

N'HÉSITEZ PAS À NOUS CONTACTER SI VOUS DÉSIREZ OBTENIR DE PLUS AMPLES INFORMATIONS OU DES ÉCHANTILLONS !



STANDAARDUITVOERING MET GEKLEURDE GROEF
VERSION STANDARD AVEC RAINURE COLORÉE

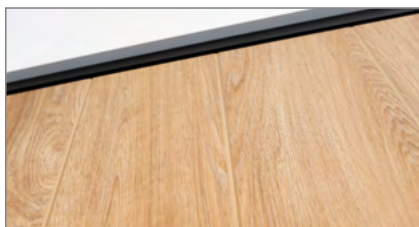

UITVOERING MET ZWARTE GROEF
VERSION AVEC RAINURE NOIRE



BESCHIKBARE KLEUREN | COULEURS DISPONIBLES

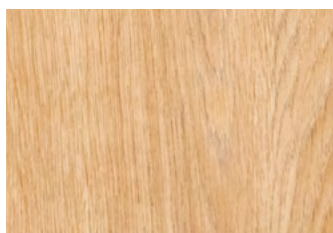

WTM
(WOODEC TURNER OAK MALT)

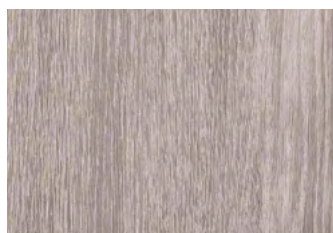

WSOC
(WOODEC SHEFFIELD OAK CONCRETE)





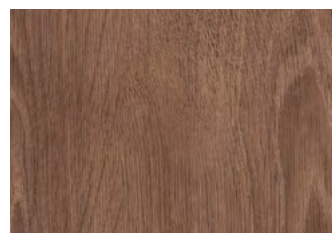



WSA
(WOODEC SHEFFIELD OAK ALPINE)

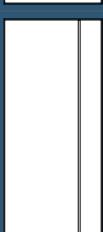

WOT
(WOODEC TURNER OAK TOFFEE)

detail trekkers | détail tirants

STANDAARD MAGNETUDE • D'OFFICE EN MAGNETUDE standaard ft standard 990 x 2190		VLEUGELOVERDEKKEND CACHE-OUVRANT magnetude					
		PVC wit blanc • beige crème • 120 140 150	EXT folie filmé • INT wit blanc • beige crème	EXT folie filmé • INT folie filmé	RAL poeder poudre p. 172-174	RAL pistool pistolet	2 ZIJDEN FACES p. 7-11
 <p>FREYA MI451 FLAT</p> <p>300 x 1680mm</p>	M1	1237	1291	1352	1237	1413	+832
	M2						
 <p>ARES MI281 FLAT + TUBE 011 HOR</p> <p>540 x 540mm</p>	M1	1583	1696	1696	1583	1752	+832
	M2						
 <p>APOLLO MI291 FLAT + TUBE 011 VER</p> <p>540 x 540mm</p>	M1	1667	1780	1780	1667	1836	+832
	M2						
 <p>MORRIGAN MI651 FLAT + TUBE 021 HOR</p> <p>540 x 540mm</p>	M1	1583	1696	1696	1583	1752	+832
	M2						
 <p>MERLIN MI661 FLAT + TUBE 021 VER</p> <p>540 x 540mm</p>	M1	1667	1780	1780	1667	1836	+832
	M2						
 <p>AMON MI301 FLAT + TUBE 016 HOR</p> <p>540 x 540mm</p>	M1	1583	1696	1696	1583	1752	+832
	M2						

Indicatif: afhankelijk van de afmetingen A, B, C, D. | Indicatif : dépend des dimensions A, B, C, D.

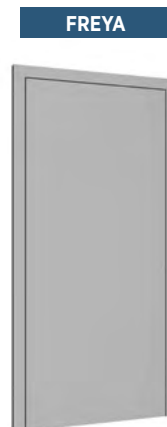

FREYA



ARES



DB2811PL - p. 160



APOLLO



DB2911PL - p. 161



MORRIGAN



DB2821PL - p. 160



MERLIN



DB2921PL - p. 162









AMON

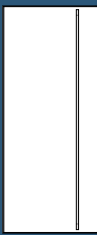

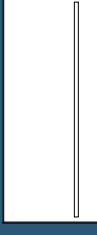
DB2816PL - p. 160

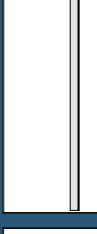





detail trekkers | détail tirants

STANDAARD MAGNETUDE • D'OFFICE EN MAGNETUDE standaard ft standard 990 x 2190		VLEUGELOVERDEKKEND CACHE-OUVRANT magnetude						
		PVC wit blanc • beige crème • 120 140 150	EXT folie filmé • INT wit blanc • beige crème	EXT folie filmé • INT folie filmé	RAL poeder poudre p. 172-174	RAL pistool pistolet	2 ZIJDEN FACES p. 7-11	
	HADES MI311 2 FLAT + TUBE 016 VER	M1	1667	1780	1780	1667	1836	+832
	M2							
	SIRONA MI681 2 FLAT + TUBE 013 HOR	M1	1583	1696	1696	1583	1751	+832
	M2							
	BORVO MI691 2 FLAT + TUBE 013 VER	M1	1667	1780	1780	1667	1835	+832
	M2							
	HERA MI321 2 FLAT + TUBE 017 HOR	M1	1583	1696	1696	1583	1752	+832
	M2							
	VENUS MI331 2 FLAT + TUBE 017 VER	M1	1667	1780	1780	1667	1836	+832
	M2							
	JUNO MI341 2 FLAT + TUBE 018 HOR	M1	1583	1696	1696	1583	1752	+832
	M2							

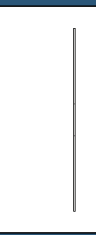
 Indicatif: afhankelijk van de afmetingen A, B, C, D. | Indicatif : dépend des dimensions A, B, C, D.

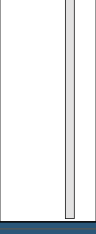

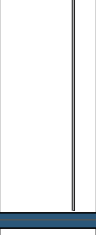
detail trekkers | détail tirants

STANDAARD MAGNETUDE • D'OFFICE EN MAGNETUDE standaard ft standard 990 x 2190		VLEUGELOVERDEKKEND CACHE-OUVRANT magnetude						
		PVC wit blanc • beige crème • 120 140 150	EXT folie filmé • INT wit blanc • beige crème	EXT folie filmé • INT folie filmé	RAL poeder poudre p. 172-174	RAL pistool pistolet	2 ZIJDEN FACES p. 7-11	
	MINERVA MI3512 FLAT + TUBE 018 VER	M1	1667	1780	1780	1667	1836	+832
		M2						
	ODIN MI3612 FLAT + TUBE 050 HOR	M1	1583	1696	1696	1583	1752	+832
		M2						
	THOR MI3712 FLAT + TUBE 050 VER	M1	1667	1780	1780	1667	1836	+832
		M2						
	ANUBIS MI3812 FLAT + TUBE 051 HOR	M1	1583	1696	1696	1583	1752	+832
		M2						
	ARTEMIS MI3912 FLAT + TUBE 051 VER	M1	1667	1780	1780	1667	1836	+832
		M2						
	BACCHUS MI4012 FLAT + TUBE 052 HOR	M1	1583	1696	1696	1583	1752	+832
		M2						

MINERVA



DB2918PL - p. 162

ODIN



DB2850PL - p. 162

THOR



DB2950PL - p. 162

ANUBIS



DB2851PL - p. 162

ARTEMIS

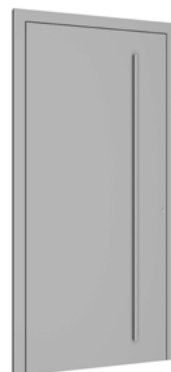

DB2951PL - p. 162



BACCHUS



DB2852PL - p. 162

Indicatif: afhankelijk van de afmetingen A, B, C, D. | Indicatif : dépend des dimensions A, B, C, D.

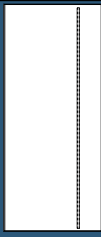
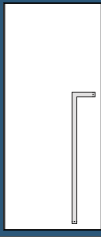
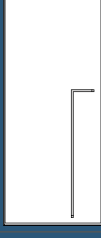
detail trekkers | détail tirants

STANDAARD MAGNETUDE • D'OFFICE EN MAGNETUDE standaard ft standard 990 x 2190		VLEUGELOVERDEKKEND CACHE-OUVRANT magnetude						
		PVC wit blanc • beige crème • 120 140 150	EXT folie filmé • INT wit blanc • beige crème	EXT folie filmé • INT folie filmé	RAL poeder poudre	RAL pistool pistolet	2 ZIJDEN FACES	
▼ buitenaanzicht vue extérieure					p. 172-174		p. 7-11	
	CHARON MI411 2 FLAT + TUBE 052 VER	M1	1667	1780	1780	1667	1836	+832
	M2 540 x 540mm							
	HERMES MI421 2 FLAT + ART 290 S	M1	2055	2168	2168	2055	2224	+832
	M2 540 x 540mm							
	MORPHEUS MI431 2 FLAT + ART 291 S	M1	1875	1988	1988	1875	2043	+832
	M2 540 x 540mm							
	WODAN MI441 2 FLAT + ART 292	M1	1568	1681	1681	1568	1737	+832
	M2 540 x 540mm							

CHARON

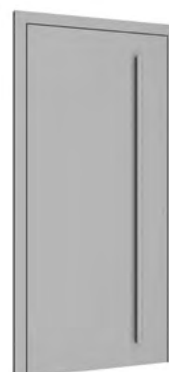

DB2952PL - p. 162

WODAN



DB2292IN - p. 159
Trekker standaard in inox

HERMES



DB2790IN - p. 159
Trekker standaard in inox

MORPHEUS



DB2791IN - p. 159
Trekker standaard in inox

detail trekkers | détail tirants

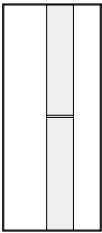
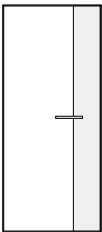
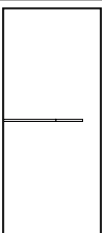
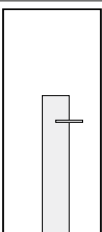
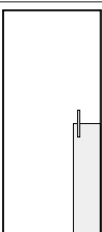
STANDAARD MAGNETUDE • D'OFFICE EN MAGNETUDE standaard ft standard 990 x 2190		VLEUGELOVERDEKKEND CACHE-OUVRANT magnetude					
		PVC wit blanc • beige crème • 120 140 150	EXT folie filmé • INT wit blanc • beige crème	EXT folie filmé • INT folie filmé	RAL poeder poudre	RAL pistool pistolet	2 ZIJDEN FACES
▼ buitenaanzicht vue extérieure					p. 172-174		p. 7-11
 MAGPIE MI541 2	M1	2638	2638	2638	2638	3896	+832
	M2						
 TAPIR MI551 2	M1	2638	2638	2638	2638	3896	+832
	M2						
 WARBLER MI561 2	M1	2860	2860	2860	2860	4117	+832
	M2						
 COLOBUS MI571 2	M1	2860	2860	2860	2860	4117	+832
	M2						
 LEMUR MI581 2	M1	2860	2860	2860	2860	4117	+832
	M2						

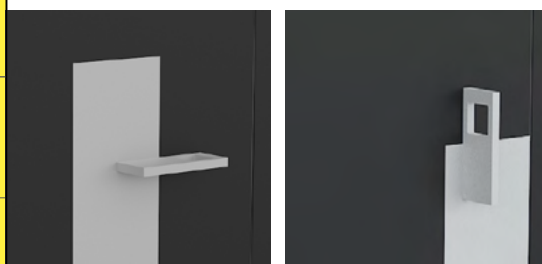

Optie "Black & white": Het paneel is zwart en de insert wit of andersom. De afwerking (mat/glans) kan afzonderlijk gekozen worden.

Optie "Full color": Het paneel heeft een kleur en afwerking (mat/ glans) naar keuze. De insert heeft dezelfde kleur maar een verschillende afwerking (glans/ mat)

Trekker: De trekker heeft steeds dezelfde kleur en afwerking als de insert. Standaard wordt DB2023PL gebruikt, maar er kan ook gekozen worden voor DB2022PL. (zie p. 161)





Option "Black & White" : Le panneau est noir et l'insert blanc ou inversément.

Différentes finitions (mat/brillant) peuvent être combinées sur le même panneau.

Option "Full Color" : Le panneau peut être fabriqué dans une couleur et finition (mat/brillant) au choix. L'insert aura toujours la même couleur mais avec une finition différente.

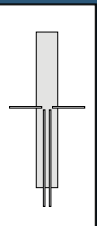
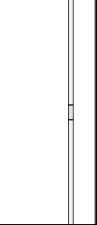
Tirant : Le tirant a la même couleur et finition que l'insert. En standard, on utilise le DB2023PL, mais l'option DB2022PL est également possible. (zie p. 161)

detail trekkers | détail tirants

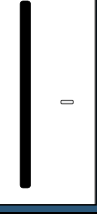
STANDAARD MAGNETUDE • D'OFFICE EN MAGNETUDE standaard ft standard 990 x 2190		VLEUGELOVERDEKKEND CACHE-OUVRANT magnetude						
		PVC wit blanc • beige crème • 120 140 150	EXT folie filmé • INT wit blanc • beige crème	EXT folie filmé • INT folie filmé	RAL poeder poudre p. 172-174	RAL pistool pistolet p. 7-11	2 ZIJDEN FACES	
	LOKI MI591 2	M1	2594	2344	2418	2594	2753	+1107
		M2						
	KEPLER MI041 2 UNO 4.0	M1	1644	1644	1644	1644	1888	+832
		M2						
	HUBBLE MI061 2 UNO 5.0	M1	1614	1614	1614	1614	1854	+832
		M2						
	LOCASTE MI121 2 ONE 6.0	M1	1635	1635	1635	1635	1878	+832
		M2						
	SPONDE MI141 2 ONE 8.0	M1	1620	1620	1620	1620	1860	+832
		M2						
	EUPORIE MI161 2 ONE 7.10	M1	2400	2408	2477	2400	2620	+1107
		M2						

LOKI

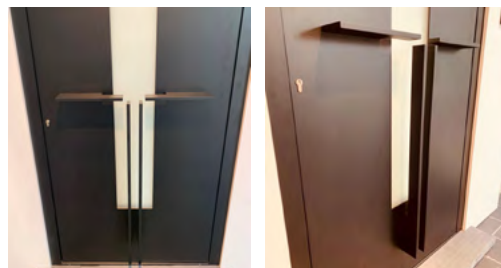

KEPLER | HUBBLE

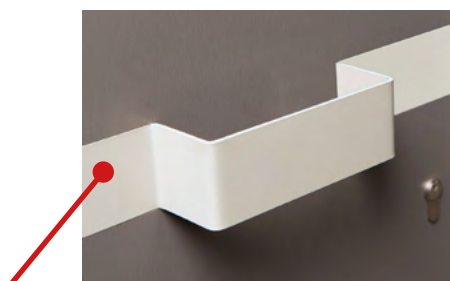

inoxlook

LOCASTE

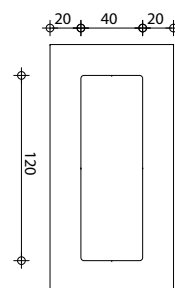

inoxlook

SPONDE | EUPORIE

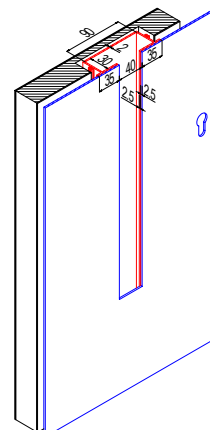
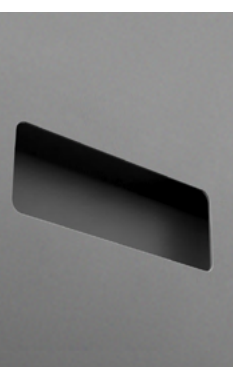

Indicatif: afhankelijk van de afmetingen A, B, C, D. | Indicatif: dépend des dimensions A, B, C, D.



MI591 Loki

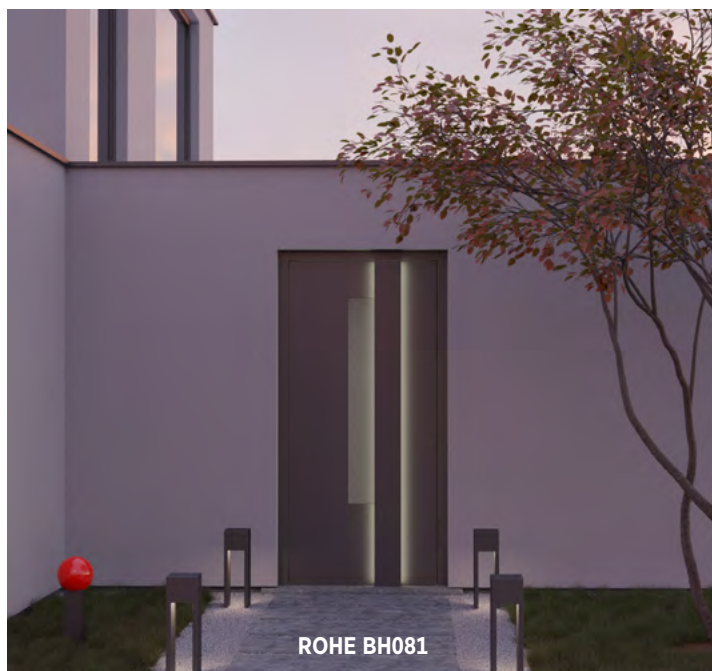

Supplementen | Suppléments

magnetude	1 ZIJDE FACE					2 ZIJDEN FACES				
	PVC	1Z folie filmé	2Z folie filmé	RAL poeder poudre	RAL pistool pistolet	PVC	1Z folie filmé	2Z folie filmé	RAL poeder poudre	RAL pistool pistolet
Formaat • Format										
990 x 2190	0	0	0	0	0	0	0	0	0	0
1240 x 2490	272	-	-	272	272	427	-	-	427	427
1140 x 2490	-	272	272	-	-	-	427	427	-	-
1140 x 2990	-	836	836	-	-	-	1226	1226	-	-
1490 x 2990	543	-	-	543	543	851	-	-	851	851

info

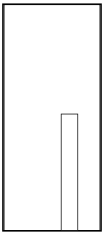
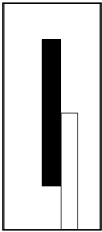
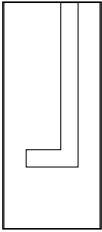
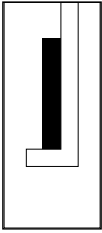
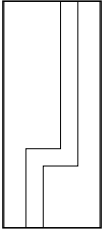
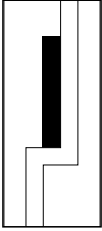
systeem magnetude • système magnetude Standaard ft standard 1000 X 2200 ▼ buitenaanzicht vue extérieure		VLEUGELOVERDEKKEND CACHE-OUVRANT magnetude								
		PVC wit blanc • beige crème • 120 140 150	EXT folie filmé • INT wit blanc • beige crème	EXT folie filmé • INT folie filmé	RAL poeder poudre p. 172-174	RAL pistool pistolet	2 ZIJDEN FACES p. 7-11	LED wit blanc LED RGB		
 BREUER BH011 2 400 x 1500mm	M1	2256	2307	2367	2256	2425	+832	+995	wit blanc	
	M2								RGB 1545	
 BRANDT BH021 2 552 x 1650mm	M1	3078	3130	3189	3078	3247	+1621	+995	wit blanc	
	M2								RGB 1545	
 STAM BH031 2 552 x 1500mm	M1	2585	2637	2695	2585	2754	+832	+1195	wit blanc	
	M2								RGB 1795	
 KLEE BH041 2 552 x 1650mm	M1	3407	3459	3517	3407	3576	+1621	+1195	wit blanc	
	M2								RGB 1795	
 MOHOLY BH051 2 552 x 1500mm	M1	2585	2637	2695	2585	2754	+832	+1195	wit blanc	
	M2								RGB 1795	
 WAGENFELD BH061 2 552 x 1650mm	M1	3407	3459	3517	3407	3576	+1621	+1195	wit blanc	
	M2								RGB 1795	

BREUER



BRANDT



STAM



KLEE



MOHOLY



WAGENFELD



Indicatif: afhankelijk van de afmetingen A, B, C, D. | Indicatif: dépend des dimensions A, B, C, D.

info

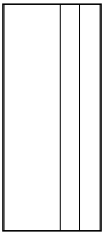
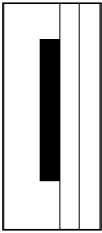
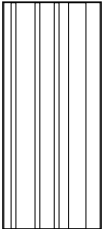
systeem magnetude • système magnetude		VLEUGELOVERDEKKEND CACHE-OUVRANT magnetude								
		PVC wit blanc • beige crème • 120 140 150	EXT folie filmé • INT wit blanc • beige crème	EXT folie filmé • INT folie filmé	RAL poeder poudre • p. 172-174	RAL pistool pistolet • p. 7-11	2 ZIJDEN FACES		LED wit blanc	LED RGB
Standaard ft standard 1000 X 2200										
▼ buitenaanzicht vue extérieure										
 <p>GROPIUS BH071 2</p> <p>400 x 1500mm</p>	M1	1928	1978	2038	1928	2096	+832	wit blanc +1195		
	M2							RGB 1795		
 <p>ROHE BH081 2</p> <p>552 x 1650mm</p>	M1	2750	2801	2860	2750	2918	+1621	wit blanc +1195		
	M2							RGB 1795		
 <p>KANDINSKY BH091 2</p> <p>680 x 1500mm</p>	M1	3425	3477	3535	3425	3594	+832	wit blanc +2980		
	M2							RGB 4255		

GROPIUS



ROHE



KANDINSKY



GROPIUS



+ LED

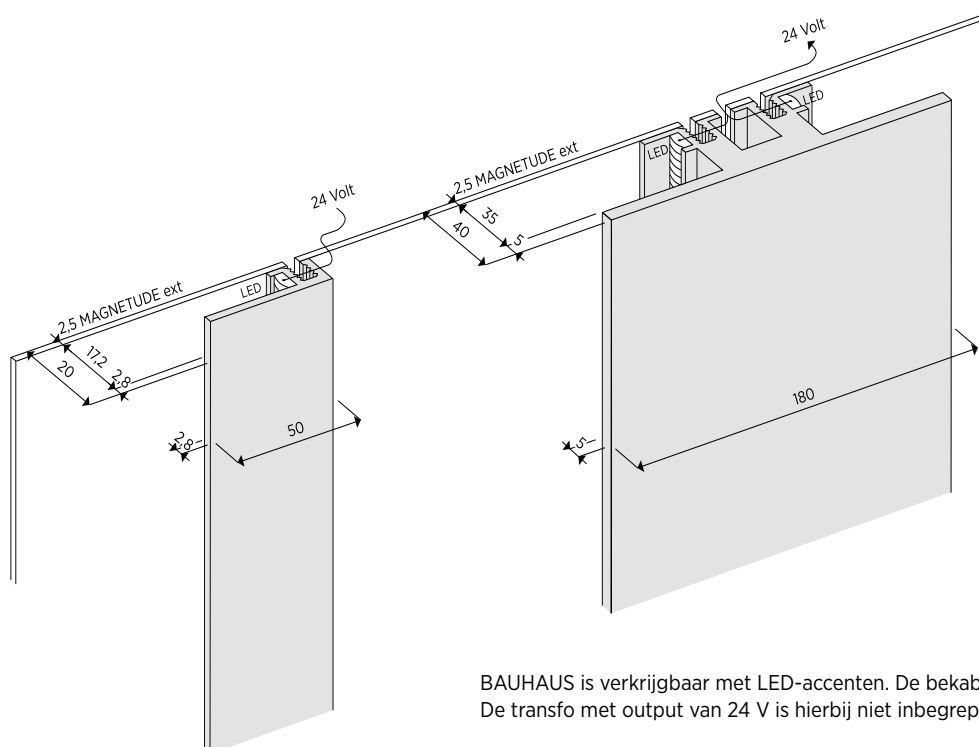

BAUHAUS is verkrijgbaar met LED-accenten. De bekabeling loopt tussen het voorvel en het vulpaneel. De transformator met output van 24 V is hierbij niet inbegrepen.

BAUHAUS est disponible avec accents LED. Le câblage pass entre la tôle extérieure et le panneau de remplissage. Le transformateur de 24 V n'est pas inclus.



frager.

CREATORS OF DOORS

solinox



Informatie | Information

Kernen • Ames	MU 20	ISOL + 22	HDP 25	THERMI-MAX 33	FLAMEBOARD 200 + (a)	ISOMIX 37	AMAC 38 (b)	ISOMIX 40	ISOMIX 43
Totale dikte • Epaisseur totale ALU/PVC	23/24	25/26	28/29	36/37	38/39	40/41	41/42	43/44	46/47
Indien beglaasd meerprijs triple glas • Si vitré, toujours rajouter plus-value triple vitrage	-	-	-	-	-	X	-	X	X
Indien beglaasd coating 1.1 standaard • Si vitré, le vitrage sera d'office avec 1,1	-	-	-	X	-	X	-	X	X
U-waarde • Valeur U W/m ² K	3,21	1,5	1,71	1,1	1,3	0,53	2,38	0,51	0,49
RW - dB Geluidswerend, enkel onbeglaasd • Acoustique, uniquement non-vitré		26		30		28	41	28	28

PVC wit of beige
PVC blanc ou crème

Formaat • Format	MU 20	ISOL + 22	HDP 25	THERMI-MAX 33	FLAMEBOARD 200 + (a)	ISOMIX 37	AMAC 38 (b)	ISOMIX 40	ISOMIX 43
900 x 2100	105	0	71	std.	-	125	314	135	146
1050 x 2200	-	92	-	90	-	179	-	189	206

FOLIE 1 zijdig of 2 zijdig
FILME 1 face ou 2 faces

Formaat • Format	MU 20	ISOL + 22	HDP 25	THERMI-MAX 33	FLAMEBOARD 200 + (a)	ISOMIX 37	AMAC 38 (b)	ISOMIX 40	ISOMIX 43
900 x 2100	105	0	71	std.	-	125	314	135	146
1050 x 2200	-	92	-	90	-	179	-	189	206
1150 x 2500	-	-	-	422	-	422	-	422	422
1150 x 3000	-	-	-	-	-	481	-	481	481

RAL poeder of pistool
RAL poudre ou pistolet

Formaat • Format	MU 20	ISOL + 22	HDP 25	THERMI-MAX 33	FLAMEBOARD 200 + (a)	ISOMIX 37	AMAC 38 (b)	ISOMIX 40	ISOMIX 43
900 x 2100	105	0	71	std.	166	125	314	135	146
1050 x 2200	-	92	-	90	-	179	-	189	206
1250 x 2500	-	-	-	362	-	362	-	362	362
1500 x 3000	-	-	-	-	-	481	-	481	481







magnetude	1 ZIJDE FACE					2 ZIJDEN FACES				
	PVC	1Z folie filmé	2Z folie filmé	RAL poeder poudre	RAL pistool pistolet	PVC	1Z folie filmé	2Z folie filmé	RAL poeder poudre	RAL pistool pistolet
Formaat • Format										
990 x 2190	0	0	0	0	0	0	0	0	0	0
1240 x 2490	272	-	-	272	272	427	-	-	427	427
1140 x 2490	-	272	272	-	-	-	427	427	-	-
1140 x 2990	-	836	836	-	-	-	1226	1226	-	-
1490 x 2990	543	-	-	543	543	851	-	-	851	851

Formaten groter dan 1050x2200 mm zijn enkel leverbaar in België en Luxemburg. | Formats plus grands que 1050x2200 mm ne sont livrables qu'en Belgique et Luxembourg.

(a) enkel in combinatie met RAL poeder en onbeglaasd | uniquement possible en RAL poudre et non-vitré

(b) enkel onbeglaasd | uniquement non-vitré

SUPPLEMENT per paneel | par panneau

M1 1 ZIJDE MOTIEF MOTIF 1 FACE M2 2 ZIJDEN MOTIEF MOTIF 2 FACES ▼ buitenaanzicht vue extérieure	PVC wit blanc • beige crème • 120 140 150	EXT folie filmé • INT wit blanc • beige crème	EXT folie filmé • INT folie filmé	RAL poeder poudre • p. 172-174	RAL pistool pistolet	SUPPL. magnetude		opties glas / options vitrage ⓘ p. 12-13				
						1 ZIJDE FACE • p. 7-11	2 ZIJDEN FACES • p. 7-11	glas vormen • forme du vitrage	gelaagd 33.2 • feuilleté 33.2	sablé met klare board • sablé avec bord clair	coating 1,1 • met kern ISOL+ , MU20 of HDP25 • avec àme ISOL+ , MU20 ou HDP25	
												≤ 990x2190 mm
 FILOX SX011 2 57830 488 x 1660mm	M1	1436	1583	1669	1821	2011	+1185	+3127	3 x ■	+165	+205	+153
	M2	1988	2135	2221	2373	2563	+1185	+3127				
 TOROX SX021 2 57910 535 x 1660mm	M1	1302	1540	1624	1803	1959	+1089	+2204	1 x ●	+65	+108	+51
	M2	1682	1920	2004	2183	2339	+1089	+2204				
 ROTOX SX031 67910 600 x 600mm	M1	1302	1540	1624	1803	1959	+1089	+2204	1 x ●	+65	+108	+51
	M2	1682	1920	2004	2183	2339	+1089	+2204				
 NANOX SX041 2 58430 545 x 1670mm	M1	1739	1887	1972	2124	2314	+1226	+3170	3 x ♣	+195	+353	+153
	M2	2095	2243	2328	2480	2670	+1226	+3170				
 MONOX SX051 2 53010 535 x 1560mm	M1	1507	1696	1770	1949	2109	+1208	+2422	1 x ♣	+65		+51
	M2	1865	2054	2083	2307	2467	+1208	+2422				
 HEPTOX SX061 2 53610 563 x 1570mm	M1	1607	1796	1870	2049	2209	+1488	+2976	1 x ♣	+65		+51
	M2	1987	2176	2250	2429	2589	+1488	+2976				

Min. afmetingen bij inbouw. Bij **magnetude***: afhankelijk van de afmetingen A, B, C, D.
Dim. mini pour pose en feuillure. En **magnetude*** : dépend des dimensions A, B, C, D.

!!! SUPPLEMENT !!! magnetude

Voor PVC WIT SCHRIJNWERK:
basisprijs kolom RAL POEDER.
Pour CHASSIS PVC BLANC :
colonne RAL POUFRE
comme prix de base.

SUPPLEMENT per paneel | par panneau









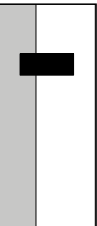

<p>M1 1 ZIJDE MOTIEF MOTIF 1 FACE</p> <p>M2 2 ZIJDEN MOTIEF MOTIF 2 FACES</p> <p>▼ buitenaanzicht vue extérieure</p>	<p>PVC wit blanc • beige crème • 120 • 140 • 150</p>	<p>EXT folie filmé • INT wit blanc • beige crème</p>	<p>EXT folie filmé • INT folie filmé</p>	<p>RAL poeder p. 172-174</p>	<p>RAL pistool p. 172-174</p>	SUPPL. magnetude		opties glas / options vitrage p. 12-13				
						1 ZIJDE FACE p. 7-11	2 ZIJDEN FACES p. 7-11	glas vormen • forme du vitrage	gelaagd 33.2 • feuilleté 33.2	sablé met klare board • sablé avec bord clair	coating 1,1 met kern ISOL+ MU20 of HDP25 • avec âme ISOL+ MU20 ou HDP25	
						900x2100x37 mm	900x2100x36 mm	900x2100x36 mm	900x2100x36 mm	900x2100x36 mm	≤ 990x2190 mm	≤ 990x2190 mm
<p>OCTOX SX071 53710</p> <p> 530 x 1760mm</p>	M1	1466	1655	1729	1908	2068	+1083	+2296	1 x	+65		+51
	M2	1865	2054	2128	2307	2467	+1083	+2296				
<p>STETOX SX081 59010</p> <p> 206 x 1606mm</p>	M1	1466	1655	1729	1908	2068	+861	+2071	1 x	+55	+68	+51
	M2	1928	2117	2123	2370	2530	+861	+2071				
<p>PRIMOX SX091 59210</p> <p> 306 x 1606mm</p>	M1	1539	1729	1803	1981	2141	+1017	+2228	1 x	+55	+68 Met klare lijnen Avec lignes claires	+51
	M2	2274	2463	2537	2716	2876	+1017	+2228			+104	
<p>TREDOX SX101 59030</p> <p> 606 x 606mm</p>	M1	1436	1583	1669	1821	2011	+1029	+2969	3 x	+165	+205 Gedeelte ge- zandstraald sablé partiel- lement	+153
	M2	2030	2327	2263	2415	2605	+1029	+2969			+196	
<p>CALLOX SX111 59040</p> <p> 356 x 1706mm</p>	M1	1580	1728	1813	1993	2156	+1134	+3418	4 x	+220	+274	+204
	M2	2172	2361	2405	2584	2747	+1134	+3418				
<p>ARNOX SX121 59050</p> <p> 586 x 1586mm</p>	M1	1593	1740	1825	2005	2168	+1249	+3868	5 x	+275	+342 Gedeelte ge- zandstraald sablé partiel- lement	+255
	M2	2187	2380	2419	2599	2762	+1249	+3868			+326	

Min. afmetingen bij inbouw. Bij **magnetude***: afhankelijk van de afmetingen A, B, C, D.
Dim. mini pour pose en feuillure. En **magnetude*** : dépend des dimensions A, B, C, D.

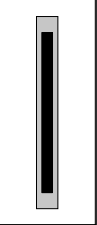
**!!! SUPPLEMENT !!!
magnetude**

Voor PVC WIT SCHRIJNWERK:
basisprijs kolom RAL POEDER.
Pour CHASSIS PVC BLANC :
colonne RAL POUDRE
comme prix de base.

SUPPLEMENT per paneel | par panneau



<p>M1 1 ZIJDE MOTIEF MOTIF 1 FACE</p> <p>M2 2 ZIJDEN MOTIEF MOTIF 2 FACES</p> <p>▼ buitenaanzicht vue extérieure</p>	<p>PVC wit blanc • beige crème • 120 140 150</p>	<p>EXT folie filmé • INT wit blanc • beige crème</p>	<p>EXT folie filmé • INT folie filmé</p>	<p>RAL poeder poudre • p. 172-174</p>	<p>RAL pistool pistolet</p>	SUPPL. magnetude		opties glas / options vitrage  p. 12-13				
						1 ZIJDE FACE •  p. 7-11	2 ZIJDEN FACES •  p. 7-11	glas vormen • forme du vitrage	gelaagd 33.2 • feuilleté 33.2	sablé met klare board • sablé avec bord clair	coating 1,1 • met kern ISOL+ , MU20 of HDP25 • avec âme ISOL+ , MU20 ou HDP25	
						≤ 990x2190 mm	≤ 990x2190 mm					
 <p>SKYBOX SX131 2 59710</p> <p> 606 x 306mm</p>	M1	1466	1655	1729	1908	2068	+861	+2071	1 x 	+55	+68 Gedeelte ge- zandstraald sablé partiel- lement +65	+51
	M2	2044	2272	2307	2486	2646	+861	+2071				
 <p>ARTOX SX141 59810</p> <p> 206 x 1606mm</p>	M1	1466	1655	1729	1908	2068	+861	+2071	1 x 	+55	+68	+51
	M2	2044	2233	2295	2486	2646	+861	+2071				
 <p>CORROX SX301</p> <p> 606 x 1800mm</p>	M1	1593	1740	1825	2005	2168	+1196	+3868	4 x 	+220		+204
	M2	2126	2319	2358	2538	2701	+1196	+3868				
	M1											
	M2											
	M1											
	M2											
	M1											
	M2											

 Min. afmetingen bij inbouw. Bij **magnetude***: afhankelijk van de afmetingen A, B, C, D.
Dim. mini pour pose en feuillure. En **magnetude*** : dépend des dimensions A, B, C, D.

**!!! SUPPLEMENT !!!
magnetude**

Voor PVC WIT SCHRIJNWERK:
basisprijs kolom RAL POEDER.
Pour CHASSIS PVC BLANC :
colonne RAL POUDRE
comme prix de base.

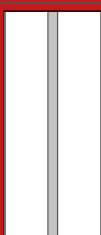
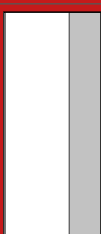

SUPPLEMENT per paneel | par panneau



M1 1 ZIJDE MOTIEF MOTIF 1 FACE M2 2 ZIJDEN MOTIEF MOTIF 2 FACES ▼ buitenaanzicht vue extérieure	PVC wit blanc • beige crème • 120 140 150	EXT folie filmé • INT wit blanc • beige crème	EXT folie filmé • INT folie filmé	RAL poeder poudre ⓘ p. 172-174	RAL pistool pistolet	SUPPL. magnetude		opties glas / options vitrage ⓘ p. 12-13				
						1 ZIJDE FACE ⓘ p. 7-11	2 ZIJDEN FACES ⓘ p. 7-11	glas vormen • forme du vitrage	gelaagd 33.2 • feuilleté 33.2	sablé met klare boord • sablé avec bord clair	coating 1,1 • met kern ISOL+ , MU20 of HDP25 • avec âme ISOL+ , MU20 ou HDP25	
						≤ 990x2190 mm	≤ 990x2190 mm					
 AQUINO SX151 DESIGN K ⓘ 150 x 300mm	M1	1232	1436	1521	1733	1889	+585	+1378				
	M2	1736	1940	2025	2459	2393	+585	+1378				
 VERMEERSCH SX161 DESIGN L ⓘ 150 x 300mm	M1	1243	1447	1532	1744	1900	+585	+1378				
	M2	1847	2051	2136	2348	2504	+585	+1378				
 LEVINAS SX171 DESIGN M ⓘ 150 x 300mm	M1	1249	1453	1538	1750	1906	+585	+1378				
	M2	1980	2184	2269	2481	2637	+585	+1378				
 BACON SX181 DESIGN N ⓘ 150 x 300mm	M1	1249	1453	1538	1750	1906	+585	+1378				
	M2	1980	2184	2269	2481	2637	+585	+1378				
 PASCAL SX191 2 DESIGN O ⓘ 150 x 300mm	M1	1372	1576	1661	1873	2029	+606	+1378				
	M2	2022	2226	2311	2523	2679	+606	+1378				
	M1											
	M2											

ⓘ Min. afmetingen bij inbouw. Bij **magnetude***: afhankelijk van de afmetingen A, B, C, D.
Dim. mini pour pose en feuillure. En **magnetude***: dépend des dimensions A, B, C, D.

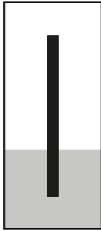
**!!! SUPPLEMENT !!!
magnetude**

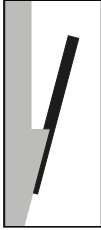
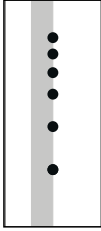
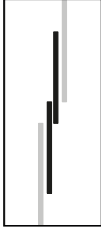
Voor PVC WIT SCHRIJNWERK:
basisprijs kolom RAL POEDER.
Pour CHASSIS PVC BLANC :
colonne RAL POUDRE
comme prix de base.

							Belangrijk Attention		
M1 1 ZIJDE MOTIEF MOTIF 1 FACE M2 2 ZIJDEN MOTIEF MOTIF 2 FACES ▼ buitenaanzicht vue extérieure		PVC wit blanc • beige crème • 120 140 150	EXT folie filmé • INT wit blanc • beige crème	EXT folie filmé • INT folie filmé	RAL poeder poudre • p. 172-174	RAL pistool pistolet	SUPPL. MAGNETUDE		EQUINOX altijd toujours glas vormen • forme du vitrage • Thermimax 33 • Acide 33.2 + 1.1 coating • Inbouwpaneel pose en feuillure
							1 ZIJDE FACE • p. 7-11	2 ZIJDEN FACES • p. 7-11	
		900x2100x37 mm	900x2100x36 mm	900x2100x36 mm	900x2100x36 mm	900x2100x36 mm	≤ 990x2190 mm	≤ 990x2190 mm	
 RIOJA SX201 EQUINOX 1 <small>206 x 1606mm</small>	M1	1032	1243	1402	1417	1734			1 x ■ acide 33.2 + 1.1 coating
	M2	1121	1418	1491	1506	1823			
 NAVARRA SX211 EQUINOX 2 <small>603 x 1606mm</small>	M1	1032	1243	1402	1417	1734			1 x ■ acide 33.2 + 1.1 coating
	M2	1121	1418	1491	1506	1823			
 MURCIA SX221 EQUINOX 3 <small>415 x 1606mm</small>	M1	1032	1243	1402	1417	1734			1 x ■ acide 33.2 + 1.1 coating
	M2	1121	1418	1491	1506	1823			
 ANDALUSIA SX231 EQUINOX 4 <small>597 x 1592mm</small>	M1	1032	1243	1402	1417	1734			1 x ■ acide 33.2 + 1.1 coating
	M2	1121	1418	1491	1506	1823			
 MANCHA SX241 EQUINOX 5 <small>333 x 1606mm</small>	M1	1032	1243	1402	1417	1734			1 x ■ acide 33.2 + 1.1 coating
	M2	1121	1418	1491	1506	1823			
 BALEARES SX251 EQUINOX 6 <small>320 x 1606mm</small>	M1	1032	1243	1402	1417	1734			1 x ■ acide 33.2 + 1.1 coating
	M2	1121	1418	1491	1506	1823			
							!!! SUPPLEMENT !!! magnetude <small>Voor PVC WIT SCHRUIWWERK: basisprijs kolom RAL POEDER. Pour CHASSIS PVC BLANC : colonne RAL POUDRE comme prix de base.</small>		

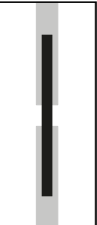
								Belangrijk Attention		
M1 1 ZIJDE MOTIEF MOTIF 1 FACE M2 2 ZIJDEN MOTIEF MOTIF 2 FACES		PVC wit blanc • beige crème • 120 140 150	EXT folie filmé • INT wit blanc • beige crème	EXT folie filmé • INT folie filmé	RAL poeder poudre p. 172-174	RAL pistool pistolet	SUPPL. MAGNETUDE		glas vormen • forme du vitrage	EQUINOX altijd toujours • Thermimax 33 • Acide 33.2 + 1.1 coating • Inbouwpaneel pose en feuillure
							1 ZIJDE FACE p. 7-11	2 ZIJDEN FACES p. 7-11		
▼ buitenaanzicht vue extérieure		900x2100x37 mm	900x2100x36 mm	900x2100x36 mm	900x2100x36 mm	900x2100x36 mm	≤ 990x2190 mm	≤ 990x2190 mm		
 <p>ARAGON SX261 EQUINOX 7</p> <p>206 x 1606mm</p>	M1	1032	1243	1402	1417	1734			1x ■	acide 33.2 + 1.1 coating
	M2	1121	1418	1491	1506	1823				
 <p>GALICIA SX271 EQUINOX 8</p> <p>520 x 1606mm</p>	M1	1032	1243	1402	1417	1734			1x ■	acide 33.2 + 1.1 coating
	M2	1121	1418	1491	1506	1823				
 <p>ASTURIA SX281 EQUINOX 9</p> <p>657 x 1685mm</p>	M1	1032	1243	1402	1417	1734			1x ■	acide 33.2 + 1.1 coating
	M2	1121	1418	1491	1506	1823				
 <p>CATALUNIA SX291 EQUINOX 10</p> <p>260 x 1606mm</p>	M1	1032	1243	1402	1417	1734			1x ■	acide 33.2 + 1.1 coating
	M2	1121	1418	1491	1506	1823				
	M1									
	M2									
	M1									
	M2									
							!!! SUPPLEMENT !!! magnetude Voor PVC WIT SCHRUIJWERK: basisprijs kolom RAL POEDER. Pour CHASSIS PVC BLANC : colonne RAL POUDRE comme prix de base.			

supplement - DECO GLAS | VITRAGES DÉCO

**FILOX
SX011|2**

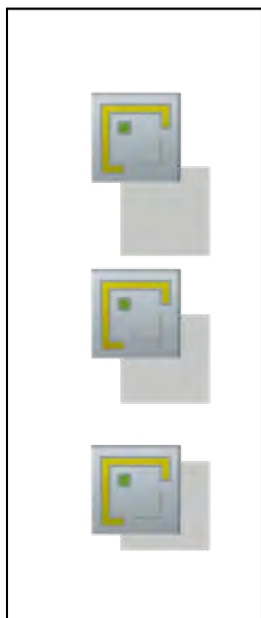

D178B + € 807

**NANOX
SX041|2**



D184B + € 807

supplement - GEDEELTE GEZANDSTRAALD | SABLÉ PARTIELLEMENT

**PRIMOX
SX091|2**

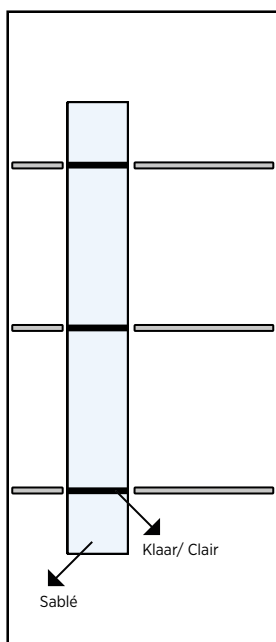

MKL* + € 104

*Met klare lijnen
Avec ligne claire

**TREDOX
SX101|2**

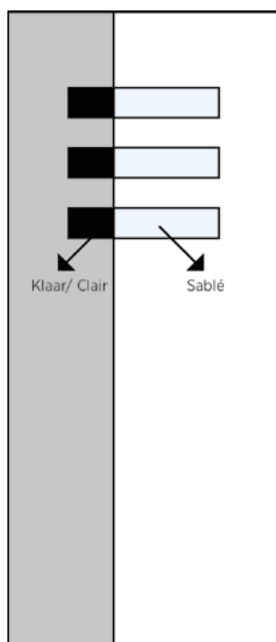

GG + € 196**

**Gedeelte gezandstraald
Sablé partiellement

**ARNOX
SX121|2**

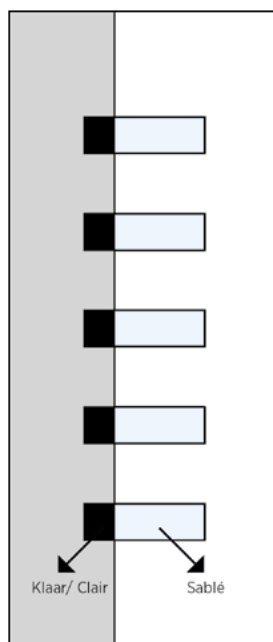

GG + € 326**

**Gedeelte gezandstraald
Sablé partiellement

**SKYBOX
SX131|2**

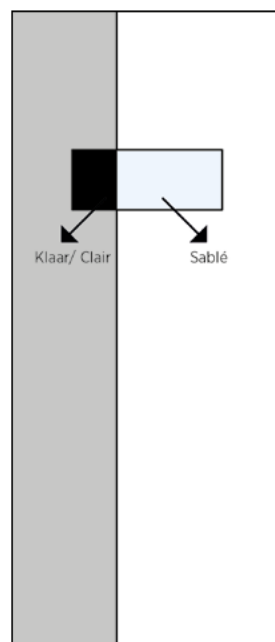

GG + € 65**

**Gedeelte gezandstraald
Sablé partiellement



Informatie | Information

Kernen • Ames	MU 20	ISOL + 22	HDP 25	THERMI-MAX 33	FLAMEBOARD 200 + (a)	ISOMIX 37	ISOMIX 40	ISOMIX 43
Totale dikte • Epaisseur totale ALU/PVC	23/24	25/26	28/29	36/37	38/39	40/41	43/44	46/47
Indien beglaasd meerprijs triple glas • Si vitré, toujours rajouter plus-value triple vitrage	-	-	-	-	-	X	X	X
Indien beglaasd coating 1.1 standaard • Si vitré, le vitrage sera d'office avec 1,1	-	-	-	X	-	X	X	X
U-waarde • Valeur U W/m2 K	3,21	1,5	1,71	1,1	1,3	0,53	0,51	0,49
RW - dB Geluidswerend, enkel onbeglaasd • Acoustique, uniquement non-vitré		26		30		28	28	28























PVC wit of beige PVC blanc ou crème									
Formaat • Format	MU 20	ISOL + 22	HDP 25	THERMI-MAX 33	FLAMEBOARD 200 + (a)	ISOMIX 37	ISOMIX 40	ISOMIX 43	
900 x 2100	105	0	71	std.	-	125	135	146	
1050 x 2200	-	92	-	90	-	179	189	206	

FOLIE 1 zijdig of 2 zijdig FILME 1 face ou 2 faces									
Formaat • Format	MU 20	ISOL + 22	HDP 25	THERMI-MAX 33	FLAMEBOARD 200 + (a)	ISOMIX 37	ISOMIX 40	ISOMIX 43	
900 x 2100	105	0	71	std.	-	125	135	146	
1050 x 2200	-	92	-	90	-	179	189	206	
1150 x 2500	-	-	-	422	-	422	422	422	
1150 x 3000	-	-	-	-	-	481	481	481	

RAL poeder of pistool RAL poudre ou pistolet									
Formaat • Format	MU 20	ISOL + 22	HDP 25	THERMI-MAX 33	FLAMEBOARD 200 + (a)	ISOMIX 37	ISOMIX 40	ISOMIX 43	
900 x 2100	105	0	71	std.	-	125	135	146	
1050 x 2200	-	92	-	90	-	179	189	206	
1250 x 2500	-	-	-	362	-	362	362	362	
1500 x 3000	-	-	-	-	-	481	481	481	

magnetude	1 ZIJDE FACE					2 ZIJDEN FACES				
	PVC	1Z folie filmé	2Z folie filmé	RAL poeder poudre	RAL pistool pistolet	PVC	1Z folie filmé	2Z folie filmé	RAL poeder poudre	RAL pistool pistolet
Formaat • Format										
990 x 2190	0	0	0	0	0	0	0	0	0	0
1240 x 2490	272	-	-	272	272	427	-	-	427	427
1140 x 2490	-	272	272	-	-	-	427	427	-	-
1140 x 2990	-	836	836	-	-	-	1226	1226	-	-
1490 x 2990	543	-	-	543	543	851	-	-	851	851

Formaten groter dan 1050x2200 mm zijn enkel leverbaar in België en Luxemburg. | Formats plus grands que 1050x2200 mm ne sont livrables qu'en Belgique et Luxembourg.
(a) enkel in combinatie met RAL poeder | uniquement possible en RAL poudre

						SUPPLEMENT per paneel par panneau		opties glas / options vitrage  p. 12-13				
M1 1 ZIJDE MOTIEF MOTIF 1 FACE M2 2 ZIJDEN MOTIEF MOTIF 2 FACES ▼ buitenaanzicht vue extérieure	PVC wit blanc • beige crème • 120 140 150	EXT folie filmé • INT wit blanc • beige crème	EXT folie filmé • INT folie filmé	RAL poeder poudre •  p. 176-178	RAL pistool pistolet	SUPPL. magnetude		glas vormen • forme du vitrage	gelaagd 33.2 • feuilleté 33.2	sablé met klare boord • sablé avec bord clair	coating 1,1	
	900x2100x37 mm	900x2100x36 mm	900x2100x36 mm	900x2100x36 mm	900x2100x36 mm	≤ 990x2190 mm	≤ 990x2190 mm				met kern ISOL+ , MU20 of HDP25 • avec à me ISOL+ , MU20 ou HDP25	
 CARAVAGGIO IM011 2 IM 1Y20  655 x 1696mm	M1	2812	3079	3167	3335	3498	+1400		2 x 	+130		+102
	M2								SG p. 51			
 BOTTICELLI IM021 2 IM 2X20  638 x 1662mm	M1	2507	2693	2862	3030	3131	+1459		1 x  1 x 	+130		+102
	M2								SG p. 51			
 BELLINI IM031 2 IM 4X10  660 x 1543mm	M1	2675	2942	3031	3198	3360	+1395		1 x 	+65		+51
	M2								SG p. 51			
 VERROCCHIO IM041 2 IM 6Y20 II  485 x 1667mm	M1	2594	3128	3213	3140	3316	+1383		1 x  1 x 	+120		+102
	M2								SG p. 51			
 TINTORETTO IM051 2 IM 9X10  652 x 1791mm	M1	3121	3655	3739	3666	3843	+1439		2 x 	+130		+102
	M2								SG p. 51			
 TIZIANO IM061 2 IM 11X10  564 x 1454mm	M1	2426	2692	2782	2949	3111	+1337		1 x 	+65		+51
	M2								SG p. 51			

 Min. afmetingen bij inbouw. Bij **magnetude***: afhankelijk van de afmetingen A, B, C, D.
Dim. mini pour pose en feuillure. En **magnetude***: dépend des dimensions A, B, C, D.

**!!! SUPPLEMENT !!!
magnetude**

Voor PVC WIT SCHRIJNWERK:
basisprijs kolom RAL POEDER.
Pour CHASSIS PVC BLANC :
colonne RAL-POUDRE
comme prix de base.

supplement - DECO GLAS | VITRAGES DÉCO

IM011|2
CARAVAGGIO

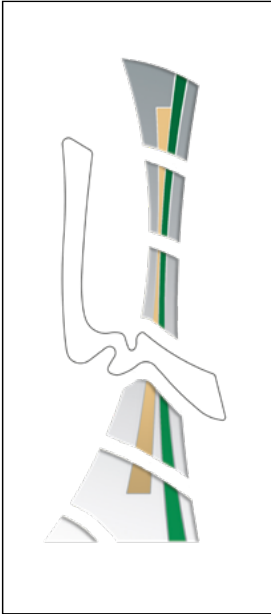

D1B € 678

IM021|2
BOTTICELLI



D2A € 678

IM031|2
BELLINI

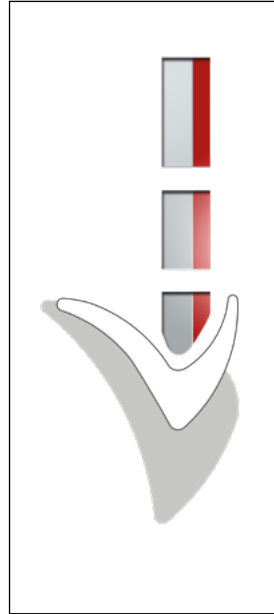

D4A € 419

IM041|2
VERROCCHIO



D6B € 678

IM051|2
TINTORETTO



D9A € 838

IM061|2
TIZIANO

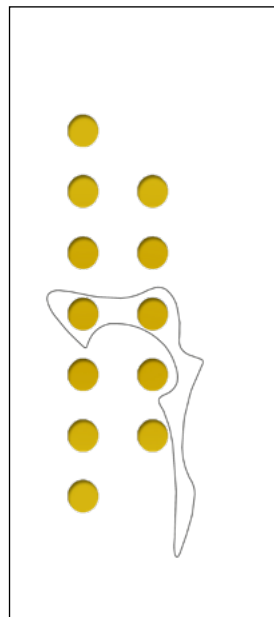

D11A € 678

t timeless



frager.

CREATORS OF DOORS

discover





Int.

Ext.



Buitenaanzicht model 2/perso
Vue extérieure mod. 2/perso

SAMENSTELLING COMPOSITION	44.6 (=SP10) + sablé / argon / 33.2 + 1.1 coating		SAMENSTELLING ASSEMBLAGE
Ug met warm edge avec intercalaire warm edge	1,1		<p>Klaar / Clair</p> <p>Sablé</p>
BRUTO PRIJS PRIX BRUT	€ 975		
DIKTE EPAISSEUR	Standaard Standard 28 mm Suppl. per par 2 mm (max. 40 mm) 18 €		<p>+</p> <p>Klaar - Clair</p>
MAX FORMAAT FORMAT MAXI	Ft.	Suppl.	
	1050 x 2200 mm	+ 0 €	
	1200 x 2400 mm	+ 390 €	
	1600 x 3000 mm	+ 1168 €	
Glas met volledige boog bovenaan Vitrage plein cintre + € 165			
Transport bruto/stuk Transport brut/pièce: € 195*			

Samenstelling en U-waardes onder voorbehoud van wijziging | Composition et valeurs sous réserve de modification
* niet van toepassing voor België en Luxemburg | pas pour la Belgique et le Luxembourg

Modellen | Modèles



DECOVER 2-00
DE011



DECOVER 2-07
DE081

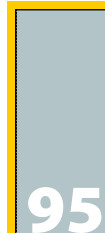

DECOVER 2-DESIGN
DE151

95

suppl. + € 115



DECOVER 2-01
DE021



DECOVER 2-08
DE091



DECOVER 2-02
DE031



DECOVER 2-09
DE101



DECOVER 2-03
DE041



DECOVER 2-11
DE111



DECOVER 2-04
DE051



DECOVER 2-12
DE121



DECOVER 2-05
DE061



DECOVER 2-13
DE131



DECOVER 2-06
DE071



DECOVER 2-14
DE141





Ext.

Int.



Detail buitenaanzicht mod. 3/design
Détail vue extérieure mod. 3/design

SAMENSTELLING COMPOSITION	44.6 (=SP10) + sablé / argon / sablé + 1.1 coating / argon / 33.2 + 1.1 coating		SAMENSTELLING ASSEMBLAGE
Ug met warm edge avec intercalaire warm edge	1,2		
BRUTO PRIJS PRIX BRUT	€ 1.380		
DIKTE EPAISSEUR	Standaard Standard 36 mm Suppl. per par 2 mm (max. 60 mm) 18 €		
MAX FORMAAT FORMAT MAXI	Ft.	Suppl.	
	1050 x 2200 mm	+ 0 €	
	1200 x 2400 mm	+ 481 €	
	1600 x 3000 mm	+ 1514 €	
Glas met volledige boog bovenaan vitrage plein cintre + € 215			
Transport bruto/stuk transport brut/pièce: € 195*			

Samenstelling en U-waardes onder voorbehoud van wijziging | Composition et valeurs sous réserve de modification
* niet van toepassing voor België en Luxemburg | pas pour la Belgique et le Luxembourg

Modellen | Modèles



DECOVER 3-01
DE321

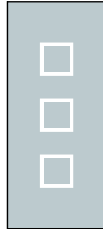

DECOVER 3-08
DE391

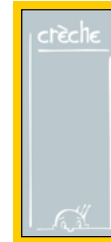

DECOVER 3-DESIGN
DE441

suppl. + € 115

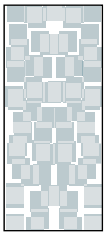

DECOVER 3-02
DE331



DECOVER 3-09
DE401



DECOVER 3-03
DE341

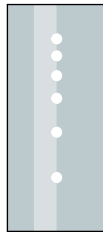

DECOVER 3-10
DE411



DECOVER 3-04
DE351



DECOVER 3-11
DE421

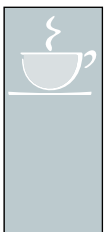

DECOVER 3-05
DE361

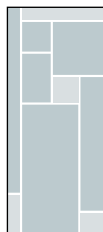

DECOVER 3-12
DE431

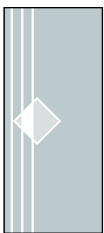

DECOVER 3-06
DE371

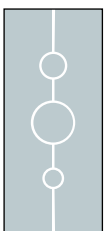

DECOVER 3-07
DE381



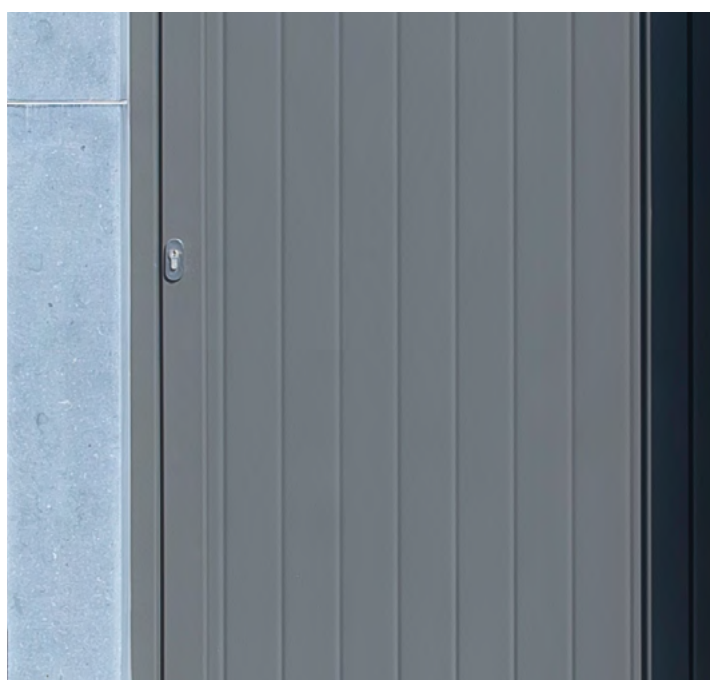
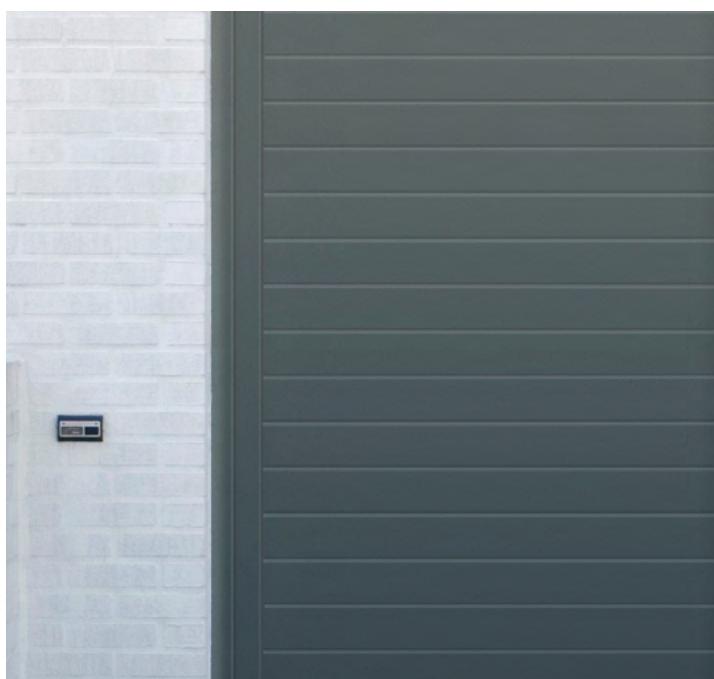



Informatie | Information

Kernen • Ames	MU 20	ISOL + 22	HDP 25	THERMI-MAX 33	FLAMEBOARD 200 + (a)	ISOMIX 37	AMAC 38	ISOMIX 40	ISOMIX 43
Totale dikte • Epaisseur totale ALU/PVC	23/24	25/26	28/29	36/37	38/39	40/41	41/42	43/44	46/47
U-waarde • Valeur U W/m2 K	3,21	1,5	1,71	1,1	1,3	0,53	2,38	0,51	0,49
RW - dB Geluidswerend, enkel onbeglaasd Acoustique, uniquement non-vitré		26		30		28	41	28	28
PVC wit of beige • PVC blanc ou crème • Folie 1 zijdig of 2 zijdig • Filmé 1 face ou 2 faces • RAL poeder of pistool • RAL poudre ou pistolet									
Formaat • Format	MU 20	ISOL + 22	HDP 25	THERMI-MAX 33	FLAMEBOARD 200 + (a)	ISOMIX 37	AMAC 38	ISOMIX 40	ISOMIX 43
900 x 2100	105	0	71	std.	166	125	314	135	146
1050 x 2200	-	92	-	90	-	179	-	189	206

(a) enkel in combinatie met RAL poeder / Uniquement possible en RAL poudre

SUPPLEMENT per paneel | par panneau

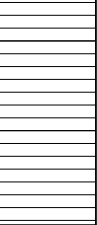

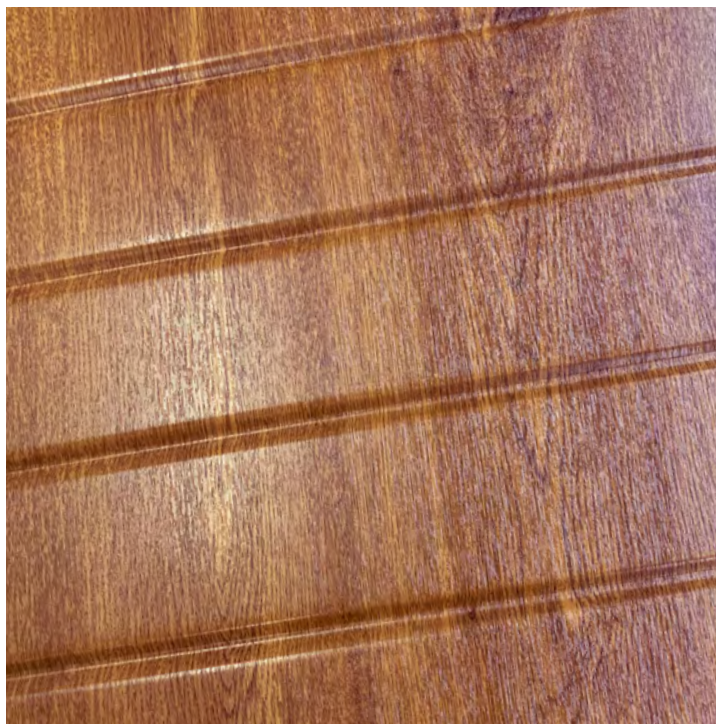
<p>M1 1 ZIJDE MOTIEF MOTIF 1 FACE</p> <p>M2 2 ZIJDEN MOTIEF MOTIF 2 FACES</p> <p>▼ buitenaanzicht vue extérieure</p>		<p>PVC wit blanc • beige crème • 120 140 150</p>	<p>EXT folie filmé • INT wit blanc • beige crème</p>	<p>EXT folie filmé • INT folie filmé</p>	<p>RAL poeder poudre • p. 172-174</p>	<p>RAL pistool pistolet</p>	SUPPL. magnetude		opties glas / options vitrage ⓘ p. 12-13			
							1 ZIJDE FACE • p. 7-11	2 ZIJDEN FACES • p. 7-11	glas vormen • forme du vitrage	gelaagd 33.2 • feuilleté 33.2	sablé met klare boord • sablé avec bord clair	coating 1.1 • met kern ISOL+, MU20 of HDP25 • avec âme ISOL+, MU20 ou HDP25
							≤ 990x2190 mm	≤ 990x2190 mm				
 <p>RAVETE RN011 VERTICAL</p> <p>↔ 98 mm</p> <p>105 x 220mm</p>	M1	671	758	783	708	935						
	M2	768	855	880	819	1044						
 <p>RAHORA RN021 HORIZONTAL</p> <p>↕ 98 mm</p> <p>105 x 220mm</p>	M1	671	758	783	708	935						
	M2	768	855	880	819	1044						
	M1											
	M2											
	M1											
	M2											
	M1											
	M2											
	M1											
	M2											



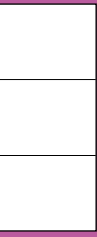
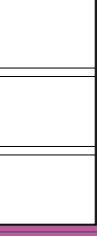

Informatie | Information

Kernen • Ames	XPS 20	XPS 25	XPS 30	XPS 33	XPS 40	XPS 50
Totale dikte • Epaisseur totale ALU/PVC	23/24	28/29	33/34	36/37	43/44	53/54
U-waarde • Valeur U W/m2 K	1,10	0,91	0,78	0,72	0,61	0,49
PVC wit of beige • PVC blanc ou crème • Folie 1 zijdig of 2 zijdig • Filmé 1 face ou 2 faces • RAL poeder of pistool • RAL poudre ou pistolet						
Formaat • Format	XPS 20	XPS 25	XPS 30	XPS 33	XPS 40	XPS 50
900 x 2100	0	0	0	std.	20	88
1050 x 2200	28	28	28	28	47	117

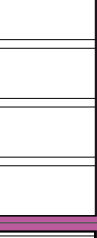
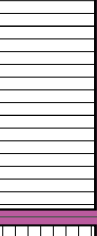
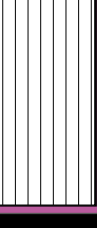
SUPPLEMENT per paneel | par panneau

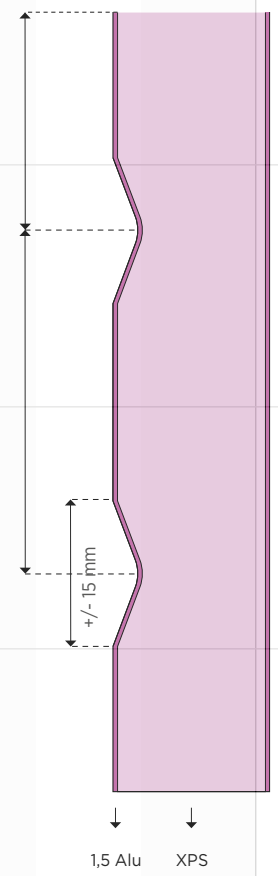
M1 1 ZIJDE MOTIEF MOTIF 1 FACE M2 2 ZIJDEN MOTIEF MOTIF 2 FACES ▼ buitenaanzicht vue extérieure		PVC wit blanc • beige crème • 120 140 150	EXT folie filmé • INT wit blanc • beige crème	EXT folie filmé • INT folie filmé	RAL poeder poudre p. 172-174	RAL pistool pistolet	SUPPL. magnetude		opties glas / options vitrage p. 12-13			
							1 ZIJDE FACE	2 ZIJDEN FACES	glas vormen	gelaagd 33.2	sablé met klare board	coating 1,1
							p. 7-11	p. 7-11	forme du vitrage	feuilleté 33.2	sablé avec bord clair	
		900x2100x37 mm	900x2100x36 mm	900x2100x36 mm	900x2100x36 mm	900x2100x36 mm	≤ 990x2190 mm	≤ 990x2190 mm				avec âme ISOL+, MU20 ou HDP25
 VEDUO VF011 MES A 105 x 220mm	M1	627	711	735	664	879						
	M2											
 VEPARA VF021 MES B 105 x 220mm	M1	627	711	735	664	879						
	M2											
 VETRIO VF031 MES C 105 x 220mm	M1	627	711	735	664	879						
	M2											
 VEVEN VF041 MES D 105 x 220mm	M1	627	711	735	664	879						
	M2											
 VEHORA VF051 V-FORM XPS HORIZONTAL 105 x 220mm	M1	627	711	735	664	879						
	M2											
 VEVETE VF061 V-FORM XPS VERTICAL 105 x 900mm	M1	627	711	735	664	879						
	M2											

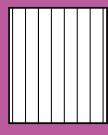

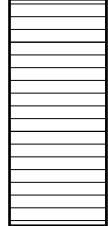
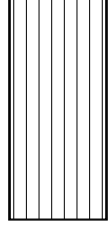
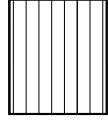
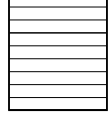
						SUPPLEMENT per paneel par panneau						
M1 1 ZIJDE MOTIEF MOTIF 1 FACE M2 2 ZIJDEN MOTIEF MOTIF 2 FACES ▼ buitenaanzicht vue extérieure		PVC wit blanc • beige crème • 120 140 150	EXT folie filmé • INT wit blanc • beige crème	EXT folie filmé • INT folie filmé	RAL poeder poudre p. 172-174	RAL pistool pistolet	SUPPL. magnetude		opties glas / options vitrage ⓘ p. 12-13			
							1 ZIJDE FACE ⓘ p. 8-12	2 ZIJDEN FACES ⓘ p. 7-11	glas vormen • forme du vitrage	gelaagd 33.2 • feuilleté 33.2	sablé met klare boord • sablé avec bord clair	coating 1,1 • met kern ISOL+, MU20 of HDP25 • avec âme ISOL+, MU20 ou HDP25
 VEVESTINA VF071 V-FORM XPS 1/2 VERTICAL 105 x 220mm	M1	351	398	411	370	491						
	M2											
 VEHORINA VF111 V-FORM XPS 1/2 HORIZONTAL 105 x 220mm	M1	351	398	411	370	491						
	M2											
 FIXORA VF081 V-FORM XPS HORIZONTAL 98 mm 105 x 220mm	M1	598	682	706	635	850						
	M2											
 FIXETE VF091 V-FORM XPS VERTICAL 98 mm 105 x 900mm	M1	598	682	706	635	850						
	M2											
 FIXINA VF101 V-FORM XPS 1/2 VERTICAL 98 mm 105 x 220mm	M1	326	375	385	345	462						
	M2											
 FIXORINA VF121 V-FORM XPS 1/2 HORIZONTAL 98 mm 105 x 220mm	M1	326	375	385	345	462						
	M2											

frager.

CREATORS OF DOORS

solo



Informatie | Information

Kernen • Ames	MU 20	ISOL + 22	HDP 25	THERMI-MAX 33	FLAMEBOARD 200 + (a)	ISOMIX 37	ISOMIX 40	ISOMIX 43
Totale dikte • Epaisseur totale ALU/PVC	23/24	25/26	28/29	36/37	38/39	40/41	43/44	46/47
Indien beglaasd meerprijs triple glas • Si vitré, toujours rajouter plus-value triple vitrage	-	-	-	-	-	X	X	X
Indien beglaasd coating 1.1 standaard • Si vitré, le vitrage sera d'office avec 1,1	-	-	-	X	-	X	X	X
U-waarde • Valeur U W/m2 K	3,21	1,5	1,71	1,1	1,3	0,53	0,51	0,49
RW - dB Geluidswerend, enkel onbeglaasd • Acoustique, uniquement non-vitré		26		30		28	28	28

PVC wit of beige
PVC blanc ou crème

Formaat • Format	MU 20	ISOL + 22	HDP 25	THERMI-MAX 33	FLAMEBOARD 200 + (a)	ISOMIX 37	ISOMIX 40	ISOMIX 43
900 x 2100	105	0	71	std.	-	125	135	146
1050 x 2200	-	92	-	90	-	179	189	206

FOLIE 1 zijdig of 2 zijdig
FILME 1 face ou 2 faces















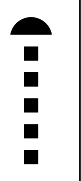







Formaat • Format	MU 20	ISOL + 22	HDP 25	THERMI-MAX 33	FLAMEBOARD 200 + (a)	ISOMIX 37	ISOMIX 40	ISOMIX 43
900 x 2100	105	0	71	std.	-	125	135	146
1050 x 2200	-	92	-	90	-	179	189	206
1150 x 3000	-	-	-	422	-	422	422	422
1150 x 3000	-	-	-	-	-	481	481	481

RAL poeder of pistool
RAL poudre ou pistolet

Formaat • Format	MU 20	ISOL + 22	HDP 25	THERMI-MAX 33	FLAMEBOARD 200 + (a)	ISOMIX 37	ISOMIX 40	ISOMIX 43
900 x 2100	105	0	71	std.	-	125	135	146
1050 x 2200	-	92	-	90	-	179	189	206
1250 x 2500	-	-	-	362	-	362	362	362
1500 x 3000	-	-	-	-	-	481	481	481

magnetude	1 ZIJDE FACE					2 ZIJDEN FACES				
	PVC	1Z folie filmé	2Z folie filmé	RAL poeder poudre	RAL pistool pistolet	PVC	1Z folie filmé	2Z folie filmé	RAL poeder poudre	RAL pistool pistolet
Formaat • Format										
990 x 2190	0	0	0	0	0	0	0	0	0	0
1240 x 2490	272	-	-	272	272	427	-	-	427	427
1140 x 2490	-	272	272	-	-	-	427	427	-	-
1140 x 2990	-	836	836	-	-	-	1226	1226	-	-
1490 x 2990	543	-	-	543	543	851	-	-	851	851

Formaten groter dan 1050x2200 mm zijn enkel leverbaar in België en Luxemburg. | Formats plus grands que 1050x2200 mm ne sont livrables qu'en Belgique et Luxembourg.
(a) enkel in combinatie met RAL poeder | uniquement possible en RAL poudre







						SUPPLEMENT per paneel par panneau		opties glas / options vitrage  p. 12-13						
M1 1 ZIJDE MOTIEF MOTIF 1 FACE M2 2 ZIJDEN MOTIEF MOTIF 2 FACES	PVC wit blanc • beige crème • 120 140 150	EXT folie filmé • INT wit blanc • beige crème	EXT folie filmé • INT folie filmé	RAL poeder poudre •  p. 172-174	RAL pistool pistolet	SUPPL. magnetude		glas vormen • forme du vitrage	gelaagd 33.2 • feuilleté 33.2	sablé met klare board • sablé avec bord clair	coating 1,1			
						1 ZIJDE FACE •  p. 7-11	2 ZIJDEN FACES •  p. 7-11				met kern ISOL+ , MU20 of HDP25 • avec âme ISOL+ , MU20 ou HDP25			
▼ buitenaanzicht vue extérieure						900x2100x37 mm	900x2100x36 mm	900x2100x36 mm	900x2100x36 mm	900x2100x36 mm	≤ 990x2190 mm	≤ 990x2190 mm		
 BRIKITA SO011 11520  485 x 1460mm	M1							1 x  1 x 	+120			+102		
	M2	1083	1298	1368	1336	1697	+785	+2162						
 PLAYA SO021 ² 13045  564 x 1562mm	M1							4 x 	+260	+432		+204		
	M2	1418	1614	1684	1855	2015	+1122	+3139						
 CARLOS SO031 ² 48035  594 x 1576mm	M1							3 x 	+195	+324		+153		
	M2	1257	1453	1523	1694	1854	+1020	+2654						
 CALLU SO041 17740  411 x 1626mm	M1							4 x 	+220	+274		+204		
	M2	1202	1398	1468	1639	1799	+1032	+2994						
 FLANDRIA SO051 17830  411 x 1626mm	M1							3 x 	+165	+205		+153		
	M2	1116	1311	1381	1373	1712	+902	+2544						
 AVERIL SO061 24530  411 x 1221mm	M1							3 x 	+165	+205		+153		
	M2	1116	1311	1381	1373	1712	+902	+2544						

 Min. afmetingen bij inbouw. Bij **magnetude***: afhankelijk van de afmetingen A, B, C, D.
Dim. mini pour pose en feuillure. En **magnetude*** : dépend des dimensions A, B, C, D.

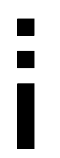
**!!! SUPPLEMENT !!!
magnetude**

Voor PVC WIT SCHRIJNWERK:
basisprijs kolom RAL POEDER.
Pour CHASSIS PVC BLANC :
colonne RAL-POUDRE
comme prix de base.

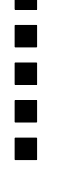





















SUPPLEMENT per paneel | par panneau

<p>M1 1 ZIJDE MOTIEF MOTIF 1 FACE</p> <p>M2 2 ZIJDEN MOTIEF MOTIF 2 FACES</p> <p>▼ buitenaanzicht vue extérieure</p>	<p>PVC wit blanc • beige crème • 120 140 150</p>	<p>EXT folie filmé • INT wit blanc • beige crème</p>	<p>EXT folie filmé • INT folie filmé</p>	<p>RAL poeder poudre • p. 172-174</p>	<p>RAL pistool pistolet</p>	SUPPL. magnetude		opties glas / options vitrage ⓘ p. 12-13			
						1 ZIJDE FACE • p. 7-11	2 ZIJDEN FACES • p. 7-11	glas vormen • forme du vitrage	gelaagd 33.2 • feuilleté 33.2	sablé met klare board • sablé avec bord clair	coating 1,1 • met kern ISOL+ , MU20 of HDP25 • avec âme ISOL+ , MU20 ou HDP25
						≤ 990x2190 mm	≤ 990x2190 mm				
 <p>ANGELA SO071 21530 ANGEL</p> <p>256 x 1306mm</p>	M1							3 x ■	+165	+205	+153
	M2	1093	1288	1358	1350	1416	+880	+2544			
 <p>NARCIS SO081 2 18430</p> <p>516 x 1671mm</p>	M1							3 x ◐	+195	+324	+153
	M2	1379	1575	1645	1636	1975	+990	+2745	SG p. 72		
 <p>ANITA SO091 2 24250</p> <p>481 x 1546mm</p>	M1							5 x ■	+275	+342	+255
	M2	1288	1484	1554	1727	1885	+1137	+3443			
 <p>ARNE SO101 24830</p> <p>506 x 1426mm</p>	M1							3 x ■	+165	+205	+153
	M2	1098	1293	1363	1355	1694	+883	+2544			
 <p>COMPTA SO111 72250</p> <p>306 x 1706mm</p>	M1							5 x ■	+275	+342	+255
	M2	1288	1484	1554	1727	1885	+1117	+3443			
 <p>HEPPY SO121 2 82610</p> <p>496 x 1571mm</p>	M1							1 x ♣	+65		+51
	M2	1249	1444	1514	1686	1844	+1366	+2732			

Min. afmetingen bij inbouw. Bij **magnetude***: afhankelijk van de afmetingen A, B, C, D.
Dim. mini pour pose en feuillure. En **magnetude***: dépend des dimensions A, B, C, D.

**!!! SUPPLEMENT !!!
magnetude**

Voor PVC WIT SCHRIJNWERK:
basisprijs kolom RAL POEDER.
Pour CHASSIS PVC BLANC :
colonne RAL-POUDRE
comme prix de base.





















						SUPPLEMENT per paneel par panneau		opties glas / options vitrage  p. 12-13						
M1 1 ZIJDE MOTIEF MOTIF 1 FACE M2 2 ZIJDEN MOTIEF MOTIF 2 FACES	PVC wit blanc • beige crème • 120 140 150	EXT folie filmé • INT wit blanc • beige crème	EXT folie filmé • INT folie filmé	RAL poeder poudre •  p. 172-174	RAL pistool pistolet	SUPPL. magnetude		glas vormen • forme du vitrage	gelaagd 33.2 • feuilleté 33.2	sablé met klare boord • sablé avec bord clair	coating 1,1			
						1 ZIJDE FACE •  p. 7-11	2 ZIJDEN FACES •  p. 7-11				met kern ISOL+ , MU20 of HDP25 • avec à me ISOL+ , MU20 ou HDP25			
▼ buitenaanzicht vue extérieure						900x2100x37 mm	900x2100x36 mm	900x2100x36 mm	900x2100x36 mm	900x2100x36 mm	≤ 990x2190 mm	≤ 990x2190 mm		
 BASSO SO131 2 19410 T1 SOPRANO  516 x 1671mm	M1							1 x 	+65	+108	+51			
	M2	1143	1339	1409	1547	1738	+778	+1713						
 ALTO SO141 2 19410 T2 SOPRANO  516 x 1671mm	M1							1 x 	+65		+51			
	M2	1176	1372	1442	1580	1771	+778	+1713						
 BARIMON SO151 2 19410 T3 SOPRANO  516 x 1671mm	M1							1 x 	+65		+51			
	M2	1176	1372	1442	1580	1771	+778	+1713						
 SOPRANO SO161 2 19410 T4  516 x 1671mm	M1							1 x 	+65		+51			
	M2	1143	1339	1409	1547	1738	+778	+1713						
 TENOR SO171 2 19410 T5 SOPRANO  516 x 1671mm	M1							1 x 	+65		+51			
	M2	1176	1372	1442	1580	1771	+778	+1713						
 VERNISSAGE SO181 74410A  506 x 506mm	M1							1 x 	+55		+51			
	M2	903	1188	1257	1428	1585	+654	+1645						

 Min. afmetingen bij inbouw. Bij **magnetude***: afhankelijk van de afmetingen A, B, C, D.
Dim. mini pour pose en feuillure. En **magnetude*** : dépend des dimensions A, B, C, D.

**!!! SUPPLEMENT !!!
magnetude**

Voor PVC WIT SCHRIJNWERK:
basisprijs kolom RAL POEDER.
Pour CHASSIS PVC BLANC :
colonne RAL-POUDRE
comme prix de base.

SUPPLEMENT per paneel | par panneau





M1 1 ZIJDE MOTIEF MOTIF 1 FACE M2 2 ZIJDEN MOTIEF MOTIF 2 FACES ▼ buitenaanzicht vue extérieure	PVC wit blanc • beige crème • 120 140 150	EXT folie filmé • INT wit blanc • beige crème	EXT folie filmé • INT folie filmé	RAL poeder poudre • p. 172-174	RAL pistool pistolet	SUPPL. magnetude		opties glas / options vitrage  p. 12-13			
						1 ZIJDE FACE  p. 7-11	2 ZIJDEN FACES  p. 7-11	glas vormen • forme du vitrage	gelaagd 33.2 • feuilleté 33.2	sablé met klare boord • sablé avec bord clair	coating 1,1 • met kern ISOL+ , MU20 of HDP25 • avec à me ISOL+ , MU20 ou HDP25
						≤ 990x2190 mm	≤ 990x2190 mm				
 VERNISSAGE SO182 74410B  506 x 506mm	M1							1 x 	+55		+51
	M2	1007	1293	1361	1603	1690	+654	+1645			
 FINISSAGE SO191 76410B  506 x 736mm	M1							1 x 	+55		+51
	M2	1027	1313	1381	1623	1710	+668	+1645			
 JURA SO201 75410B UNIC1  150 x 300mm	M1							1 x 	+55	+68	+51
	M2	839	1183	1251	1424	1581	+688	+1645			
 PERM SO211 75420B UNIC2  150 x 300mm	M1							2 x 	+110	+137	+102
	M2	993	1337	1405	1468	1625	+805	+2095			
 KRIJT SO341 75420B UNIC2  150 x 300mm	M1							2 x 	+110	+137	+102
	M2	993	1337	1405	1468	1625	+805	+2095			
 TRIAS SO221 75430B UNIC3  150 x 300mm	M1							3 x 	+165	+205	+153
	M2	1147	1492	1560	1622	1779	+920	+2544			

 Min. afmetingen bij inbouw. Bij **magnetude***: afhankelijk van de afmetingen A, B, C, D.
 Dim. mini pour pose en feuillure. En **magnetude*** : dépend des dimensions A, B, C, D.

**!!! SUPPLEMENT !!!
magnetude**

Voor PVC WIT SCHRIJNWERK:
basisprijs kolom RAL POEDER.
Pour CHASSIS PVC BLANC :
colonne RAL-POUDRE
comme prix de base.







SUPPLEMENT per paneel | par panneau





M1 1 ZIJDE MOTIEF MOTIF 1 FACE M2 2 ZIJDEN MOTIEF MOTIF 2 FACES ▼ buitenaanzicht vue extérieure		PVC wit blanc • beige crème • 120 140 150	EXT folie filmé • INT wit blanc • beige crème	EXT folie filmé • INT folie filmé	RAL poeder poudre • p. 172-174	RAL pistool pistolet	SUPPL. magnetude		opties glas / options vitrage ⓘ p. 12-13											
							1 ZIJDE FACE • p. 7-11	2 ZIJDEN FACES • p. 7-11	glas vormen • forme du vitrage	gelaagd 33.2 • feuilleté 33.2	sablé met klare board • sablé avec bord clair	coating 1,1 • met kern ISOL+ , MU20 of HDP25 • avec âme ISOL+ , MU20 ou HDP25								
													≤ 990x2190 mm	≤ 990x2190 mm	4 x ■	+220	+274	+204		
 SILUUR SO231 75440B UNIC 4 150 x 300mm	M1																			
	M2	1233	1513	1582	1664	1886	+1005	+2994												
 CARBOON SO351 UNIC 5 150 x 450mm	M1																			
	M2	1378	1658	1725	1809	2031	+1115	+3583												
 PLEISTOCEEN SO361 75410B UNIC1 150 x 300mm	M1																			
	M2	839	1183	1251	1424	1581	+639	+1645												
 HOLOCEEN SO371 75420B UNIC2 150 x 300mm	M1																			
	M2	993	1337	1405	1468	1625	+761	+2095												
 PLIOCEEN SO381 75430B UNIC3 150 x 300mm	M1																			
	M2	1147	1492	1560	1622	1779	+883	+2544												
	M1																			
	M2																			

Min. afmetingen bij inbouw. Bij **magnetude***: afhankelijk van de afmetingen A, B, C, D.
Dim. mini pour pose en feuillure. En **magnetude*** : dépend des dimensions A, B, C, D.

**!!! SUPPLEMENT !!!
magnetude**

Voor PVC WIT SCHRIJNWERK:
basisprijs kolom RAL POEDER.
Pour CHASSIS PVC BLANC :
colonne RAL POUDRE
comme prix de base.

							Belangrijk Attention	
M1 1 ZIJDE MOTIEF MOTIF 1 FACE M2 2 ZIJDEN MOTIEF MOTIF 2 FACES ▼ buitenaanzicht vue extérieure	PVC wit blanc • beige crème • 120 140 150	EXT folie filmé • INT wit blanc • beige crème	EXT folie filmé • INT folie filmé	RAL poeder poudre ⓘ p. 172-174	RAL pistool pistolet	SUPPL. MAGNETUDE		EQUISOL altijd toujours glas vormen • forme du vitrage • Thermimax 33 • Acide 33.2 + 1.1 coating • Inbouwpaneel pose en feuillure
						1 ZIJDE FACE ⓘ p. 7-11	2 ZIJDEN FACES ⓘ p. 7-11	
	900x2100x37 mm	900x2100x36 mm	900x2100x36 mm	900x2100x36 mm	900x2100x36 mm	≤ 990x2190 mm	≤ 990x2190 mm	
 PROVENCE SO241 EQUISOL 1 206 x 1606mm	M1							acide 33.2 + 1.1 coating
	M2	888	1193	1261	1288	1592		1 x ■
 NORMANDIE SO251 EQUISOL 2 206 x 1606mm	M1							acide 33.2 + 1.1 coating
	M2	888	1193	1261	1288	1592		1 x ■
 DEVOON SO331 EQUISOL 3 206 x 1606mm	M1							acide 33.2 + 1.1 coating
	M2	888	1193	1261	1288	1592		1 x ■
 ELZAS SO261 EQUISOL 4 597 x 1592mm	M1							acide 33.2 + 1.1 coating
	M2	888	1193	1261	1288	1592		1 x ■
 BRETAGNE SO271 EQUISOL 5 206 x 1606mm	M1							acide 33.2 + 1.1 coating
	M2	888	1193	1261	1288	1592		1 x ■
 AQUITAINE SO281 EQUISOL 6 206 x 1606mm	M1							acide 33.2 + 1.1 coating
	M2	888	1193	1261	1288	1592		1 x ■
						!!! SUPPLEMENT !!! magnetude Voor PVC WIT SCHRUIJWERK: basisprijs kolom RAL POEDER. Pour CHASSIS PVC BLANC : colonne RAL POUDRE comme prix de base.		

							Belangrijk Attention		
M1 1 ZIJDE MOTIEF MOTIF 1 FACE M2 2 ZIJDEN MOTIEF MOTIF 2 FACES ▼ buitenaanzicht vue extérieure	PVC wit blanc • beige crème • 120 140 150	EXT folie filmé • INT wit blanc • beige crème	EXT folie filmé • INT folie filmé	RAL poeder poudre ⓘ p. 172-174	RAL pistool pistolet	SUPPL. MAGNETUDE		EQUISOL altijd toujours glas vormen • forme du vitrage • Thermimax 33 • Acide 33.2 + 1.1 coating • Inbouwpaneel pose en feuillure	
						1 ZIJDE FACE ⓘ p. 7-11	2 ZIJDEN FACES ⓘ p. 7-11		
		900x2100x37 mm	900x2100x36 mm	900x2100x36 mm	900x2100x36 mm	900x2100x36 mm	≤ 990x2190 mm	≤ 990x2190 mm	
	DORDOGNE SO291 EQUISOL 7 206 x 1606mm	M1							acide 33.2 + 1.1 coating 1 x ■
	M2	888	1193	1261	1288	1592			
	AUVERGNE SO301 EQUISOL 8 206 x 1606mm	M1							acide 33.2 + 1.1 coating 1 x ■
	M2	888	1193	1261	1288	1592			
	BOURGONDIE SO311 EQUISOL 9 206 x 1606mm	M1							acide 33.2 + 1.1 coating 1 x ■
	M2	888	1193	1261	1288	1592			
	ARDECHE SO321 EQUISOL 10 206 x 1606mm	M1							acide 33.2 + 1.1 coating 1 x ■
	M2	888	1193	1261	1288	1592			
		M1							
		M2							
		M1							
		M2							
						!!! SUPPLEMENT !!! magnetude Voor PVC WIT SCHRUIJWERK: basisprijs kolom RAL POEDER. Pour CHASSIS PVC BLANC : colonne RAL POUDRE comme prix de base.			

**CALLU
S0041**

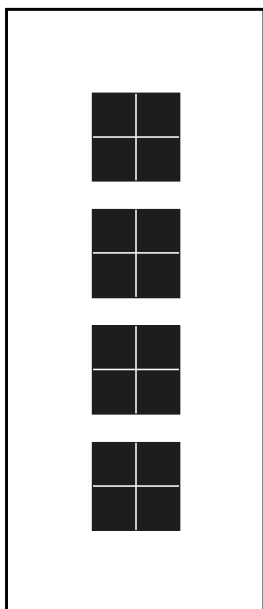

4xK01

**FLANDRIA
S0051**

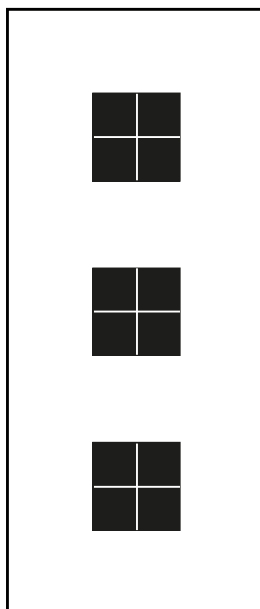

3xK01

**AVERIL
S0061**

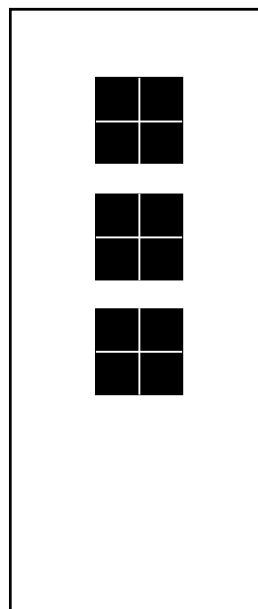

3xK01

Voor opties, prijzen en beperkingen zie p. 16 | Pour options, prix et limitations voir p. 16

supplement - SIERGLAZEN | VITRAGES DÉCORATIFS

**BRIKITA
S0011**



D115

€ 678

**FLANDRIA
S0051**



D178B

€ 807

**AVERIL
S0061**

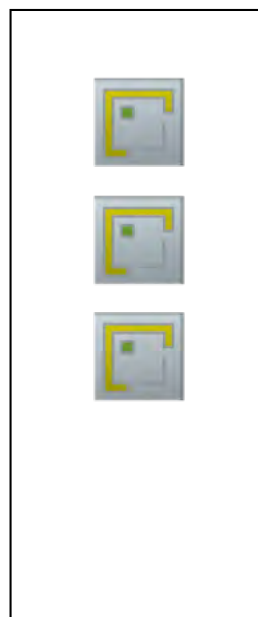

D178B

€ 807

**NARCIS
S0081²**



D184B

€ 807

f.rager.

CREATORS OF DOORS

light design



Informatie | Information

Kernen • Ames	MU 20	ISOL + 22	HDP 25	THERMI-MAX 33	FLAMEBOARD 200 + (a)	ISOMIX 37	AMAC 38 (b)	ISOMIX 40	ISOMIX 43
Totale dikte • Epaisseur totale ALU/PVC	23/24	25/26	28/29	36/37	38/39	40/41	41/42	43/44	46/47
Indien beglaasd meerprijs triple glas • Si vitré, toujours rajouter plus-value triple vitrage	-	-	-	-	-	X	-	X	X
Indien beglaasd coating 1.1 standaard • Si vitré, le vitrage sera d'office avec 1,1	-	-	-	X	-	X	-	X	X
U-waarde • Valeur U W/m2 K	3,21	1,5	1,71	1,1	1,3	0,53	2,38	0,51	0,49
RW - dB Geluidswerend, enkel onbeglaasd • Acoustique, uniquement non-vitré		26		30		28	41	28	28

PVC wit of beige PVC blanc ou crème										
Formaat • Format	MU 20	ISOL + 22	HDP 25	THERMI-MAX 33	FLAMEBOARD 200 + (a)	ISOMIX 37	AMAC 38 (b)	ISOMIX 40	ISOMIX 43	
900 x 2100	105	0	71	std.	-	125	314	135	146	
1050 x 2200	-	92	-	90	-	179	-	189	206	

FOLIE 1 zijdig of 2 zijdig FILME 1 face ou 2 faces										
Formaat • Format	MU 20	ISOL + 22	HDP 25	THERMI-MAX 33	FLAMEBOARD 200 + (a)	ISOMIX 37	AMAC 38 (b)	ISOMIX 40	ISOMIX 43	
900 x 2100	105	0	71	std.	-	125	314	135	146	
1050 x 2200	-	92	-	90	-	179	-	189	206	
1150 x 2500	-	-	-	422	-	422	-	422	422	
1150 x 3000	-	-	-	-	-	481	-	481	481	











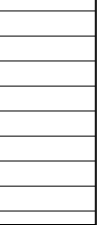
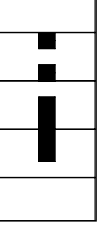

RAL poeder of pistool RAL poudre ou pistolet										
Formaat • Format	MU 20	ISOL + 22	HDP 25	THERMI-MAX 33	FLAMEBOARD 200 + (a)	ISOMIX 37	AMAC 38 (b)	ISOMIX 40	ISOMIX 43	
900 x 2100	105	0	71	std.	166	125	314	135	146	
1050 x 2200	-	92	-	90	-	179	-	189	206	
1250 x 2500	-	-	-	362	-	362	-	362	362	
1500 x 3000	-	-	-	-	-	481	-	481	481	

magnetude	1 ZIJDE FACE					2 ZIJDEN FACES				
	PVC	1Z folie filmé	2Z folie filmé	RAL poeder poudre	RAL pistool pistolet	PVC	1Z folie filmé	2Z folie filmé	RAL poeder poudre	RAL pistool pistolet
Formaat • Format										
990 x 2190	0	0	0	0	0	0	0	0	0	0
1240 x 2490	272	-	-	272	272	427	-	-	427	427
1140 x 2490	-	272	272	-	-	-	427	427	-	-
1140 x 2990	-	836	836	-	-	-	1226	1226	-	-
1490 x 2990	543	-	-	543	543	851	-	-	851	851

Formaten groter dan 1050x2200 mm zijn enkel leverbaar in België en Luxemburg. | Formats plus grands que 1050x2200 mm ne sont livrables qu'en Belgique et Luxembourg.

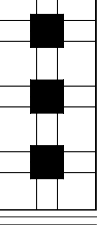
(a) enkel in combinatie met RAL poeder en onbeglaasd | uniquement possible en RAL poudre et non-vitré

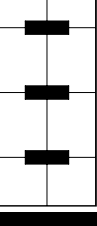
(b) enkel onbeglaasd | uniquement non-vitré

						SUPPLEMENT per paneel par panneau		opties glas / options vitrage  p. 12-13				
M1 1 ZIJDE MOTIEF MOTIF 1 FACE M2 2 ZIJDEN MOTIEF MOTIF 2 FACES ▼ buitenaanzicht vue extérieure	PVC wit blanc • beige crème • 120 140 150	EXT folie filmé • INT wit blanc • beige crème	EXT folie filmé • INT folie filmé	RAL poeder poudre  p. 172-174	RAL pistool pistolet	SUPPL. magnetude		glas vormen • forme du vitrage	gelaagd 33.2 • feuilleté 33.2	sablé met klare board • sablé avec bord clair	coating 1,1	
						1 ZIJDE FACE  p. 7-11	2 ZIJDEN FACES  p. 7-11				met kern ISOL+, MU20 of HDP25 • avec âme ISOL+, MU20 ou HDP25	
		900x2100x37 mm	900x2100x36 mm	900x2100x36 mm	900x2100x36 mm	900x2100x36 mm	≤ 990x2190 mm	≤ 990x2190 mm				
 NEW YORK LD011 901 I (2) ↔ 128 mm 150 x 300mm	M1	579	936	1009	1116	1296	+463	+1196				
	M2	690	1281	1281	1228	1420	+463	+1196				
 AMSTERDAM LD021 902 I (2) ↔ 200 mm 150 x 300mm	M1	579	936	1009	1116	1296	+463	+1196				
	M2	690	1281	1281	1228	1420	+463	+1196				
 ANGELINO LD031 21530 ANGEL I (2) 256 x 1306mm	M1	1202	1366	1441	1739	1989	+880	+2544	3 x 	+165	+205	+153
	M2	1312	1718	1718	1850	2112	+880	+2544				
 KOBE LD041 92120 II (1) 514 x 1660mm	M1	1181	1505	1580	1705	1867	+715	+2228	2 x 	+130	+216	+102
	M2	1297	1858	1858	1835	1997	+846	+2228				
 LORD LD051 92330 II (1) 411 x 1626mm	M1	1198	1362	1437	1825	1985	+878	+2544	3 x 	+165	+205	+153
	M2	1307	1713	1713	1946	2107	+878	+2544	SG p. 84			
 MASTER LD061 92430 II (1) 506 x 1426mm	M1	1206	1370	1445	1833	1993	+883	+2544	3 x 	+165	+205	+153
	M2	1317	1723	1723	1956	2117	+883	+2544				



 Min. afmetingen bij inbouw. Bij **magnetude***: afhankelijk van de afmetingen A, B, C, D. Dim. mini pour pose en feuillure. En **magnetude*** : dépend des dimensions A, B, C, D.

⁽¹⁾ infrezing **I** ook mogelijk | fraisage **I** aussi possible  p. 83

⁽²⁾ infrezing **II** ook mogelijk | fraisage **II** aussi possible  p. 83

!!! SUPPLEMENT !!! magnetude

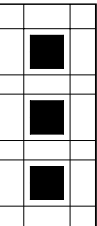
Voor PVC WIT SCHRIJNWERK: basisprijs kolom RAL POEDER.
Pour CHASSIS PVC BLANC : colonne RAL-POUDRE comme prix de base.

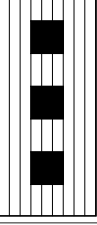
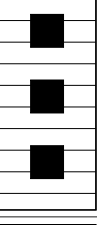
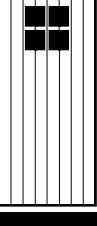
											SUPPLEMENT per paneel par panneau			
M1 1 ZIJDE MOTIEF MOTIF 1 FACE M2 2 ZIJDEN MOTIEF MOTIF 2 FACES ▼ buitenaanzicht vue extérieure							SUPPL. magnetude		opties glas / options vitrage ⓘ p. 12-13					
		PVC wit blanc • beige crème • 120 140 150	EXT folie filmé • INT wit blanc • beige crème	EXT folie filmé • INT folie filmé	RAL poeder poudre • ⓘ p. 172-174	RAL pistool pistolet	1 ZIJDE FACE • ⓘ p. 7-11	2 ZIJDEN FACES • ⓘ p. 7-11	glas vormen • forme du vitrage	gelaagd 33.2 • feuilleté 33.2	sablé met klare boord • sablé avec bord clair	coating 1,1 • met kern ISOL+, MU20 of HDP25 • avec à me ISOL+, MU20 ou HDP25		
		900x2100x37 mm	900x2100x36 mm	900x2100x36 mm	900x2100x36 mm	900x2100x36 mm	≤ 990x2190 mm	≤ 990x2190 mm						
 TASTE LD071 92630 II (1) 501 x 1716mm	M1	1206	1370	1445	1833	1993	+902	+2544	3 x ■	+165	+205	+153		
	M2	1317	1723	1723	1956	2117	+902	+2544	SG p. 84					
 HEPRO LD081 2 93610 I (2) 496 x 1571mm	M1	1533	1724	1998	2124	2279	+1366	+2732	1 x ♣	+65		+51		
	M2	1644	2050	2130	2244	2399	+1366	+2732						
 OCTAVE LD091 2 93710 II (1) 512 x 1756mm	M1	1490	1681	1955	2081	2236	+732	+1779	1 x ♣	+65		+51		
	M2	1597	2003	2083	2197	2352	+732	+1779						
 CADENS LD101 94130 II (1) ↔ 95 mm 411 x 1626mm	M1	1206	1370	1445	1833	1993	+902	+2544	3 x ■	+165	+205	+153		
	M2	1317	1723	1723	1956	2117	+902	+2544	SG p. 84					
 RITMO LD111 94230 II (1) ↕ 197 mm 411 x 1626mm	M1	1206	1370	1445	1833	1993	+902	+2544	3 x ■	+165	+205	+153		
	M2	1317	1723	1723	1956	2117	+902	+2544	SG p. 84					
 HERMITAGE LD121 94410A II (1) ↔ 110 mm 506 x 506mm	M1	978	1303	1378	1698	1856	+654	+1859	1 x ■	+55		+51		
	M2	1089	1650	1650	1821	1981	+654	+1859						















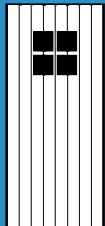

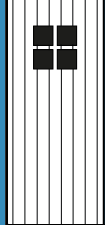
ⓘ Min. afmetingen bij inbouw. Bij **magnetude**®: afhankelijk van de afmetingen A, B, C, D.
Dim. mini pour pose en feuillure. En **magnetude**® : dépend des dimensions A, B, C, D.

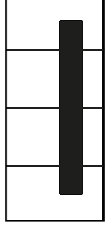
(1) infrezing I ook mogelijk | fraisage I aussi possible ⓘ p. 83

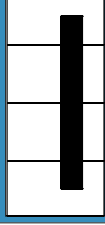
(2) infrezing II ook mogelijk | fraisage II aussi possible ⓘ p. 83

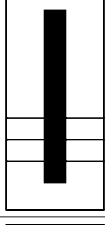

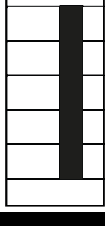
**!!! SUPPLEMENT !!!
magnetude**

Voor PVC WIT SCHRIJNWERK:
basisprijs kolom RAL POEDER.
Pour CHASSIS PVC BLANC :
colonne RAL-POUDRE
comme prix de base.

		SUPPLEMENT per paneel par panneau						opties glas / options vitrage  p. 12-13					
M1 1 ZIJDE MOTIEF MOTIF 1 FACE	M2 2 ZIJDEN MOTIEF MOTIF 2 FACES	PVC wit blanc • beige crème • 120 140 150	EXT folie filmé • INT wit blanc • beige crème	EXT folie filmé • INT folie filmé	RAL poeder poudre •  p. 172-174	RAL pistool pistolet	SUPPL. magnetude		glas vormen • forme du vitrage	gelaagd 33.2 • feuilleté 33.2	sablé met klare board • sablé avec bord clair	coating 1,1	
							1 ZIJDE FACE •  p. 7-11	2 ZIJDEN FACES •  p. 7-11				met kern ISOL+ , MU20 of HDP25 • avec âme ISOL+ , MU20 ou HDP25	
▼ buitenaanzicht vue extérieure		900x2100x37 mm	900x2100x36 mm	900x2100x36 mm	900x2100x36 mm	900x2100x36 mm	≤ 990x2190 mm	≤ 990x2190 mm					
	HERMITAGE LD122 94410B  (1)	M1	1102	1428	1503	1823	1981	+654	+1859	1 x 	+55		+51
	M2	1213	1775	1775	1945	2105	+654	+1859	Aantal lijnen oneven Nombres rainures impaires				
	HERMITAGE LD123 94410B  (1)	M1	1102	1428	1503	1823	1981	+654	+1859	1 x 	+55		+51
	M2	1213	1775	1775	1945	2105	+654	+1859	Aantal lijnen even Nombres rainures paires				
	PRILINE LD131 2 96010  (1)	M1	1071	1397	1472	1792	1950	+680	+1645	1 x 	+55	+68 Met klare lijnen Avec lignes claires +102	+51
	M2	1179	1741	1741	1911	2071	+680	+1645					
	PRILINE LD133 4 96810B COMLINE  (1)	M1	1102	1428	1503	1823	1981	+680	+1645	1 x 	+55	+68 Met klare lijnen Avec lignes claires +102	+51
	M2	1213	1775	1775	1945	2105	+680	+1645					
	BALINE LD141 96110  (1)	M1	1071	1397	1472	1792	1950	+680	+1645	1 x 	+55	+68 Met klare lijnen Avec lignes claires +102	+51
	M2	1179	1741	1741	1911	2071	+680	+1645					
	FREELINE LD151 2 96210  (1) 317.5 mm	M1	1071	1397	1472	1792	1950	+680	+1645	1 x 	+55	+68 Met klare lijnen Avec lignes claires +102	+51
	M2	1179	1741	1741	1911	2071	+680	+1645					

 Min. afmetingen bij inbouw. Bij **magnetude***: afhankelijk van de afmetingen A, B, C, D.
Dim. mini pour pose en feuillure. En **magnetude*** : dépend des dimensions A, B, C, D.













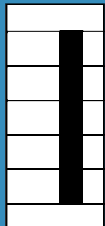

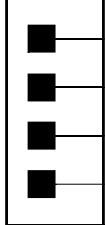
(1) infrezing  ook mogelijk | fraisage  aussi possible  p. 83

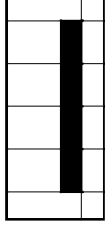
(2) infrezing  ook mogelijk | fraisage  aussi possible  p. 83

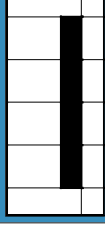
**!!! SUPPLEMENT !!!
magnetude**

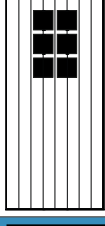
Voor PVC WIT SCHRIJNWERK:
basisprijs kolom RAL POEDER.
Pour CHASSIS PVC BLANC :
colonne RAL-POUDRE
comme prix de base.

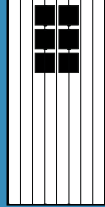
SUPPLEMENT per paneel | par panneau

M1 1 ZIJDE MOTIEF MOTIF 1 FACE M2 2 ZIJDEN MOTIEF MOTIF 2 FACES ▼ buitenaanzicht vue extérieure	PVC wit blanc • beige crème • 120 140 150	EXT folie filmé • INT wit blanc • beige crème	EXT folie filmé • INT folie filmé	RAL poeder poudre • p. 172-174	RAL pistool pistolet	SUPPL. magnetude		opties glas / options vitrage  p. 12-13				
						1 ZIJDE FACE  p. 7-11	2 ZIJDEN FACES  p. 7-11	glas vormen • forme du vitrage	gelaagd 33.2 • feuilleté 33.2	sablé met klare board • sablé avec bord clair	coating 1,1 • met kern ISOL+ , MU20 of HDP25 • avec à me ISOL+ , MU20 ou HDP25	
												≤ 990x2190 mm
 FREELINE LD153 ^{1,4} 96210 II (1) 306 x 1706mm	M1	1193	1519	1593	1913	2071	+680	+1645	1 x 	+55	+68 Met klare lijnen Avec lignes claires +102	+51
	M2	1301	1862	1862	2033	2193	+680	+1645				
 CALINE LD161 ² 96340 II (1) 356 x 1706mm	M1	1345	1509	1584	1972	2132	+1012	+2994	4 x 	+220	+274	+204
	M2	1454	1860	1860	2094	2255	+1012	+2994				
 FIXLINE LD171 ² 96410 II (1) 306 x 1706mm	M1	1071	1397	1472	1792	1950	+680	+1645	1 x 	+55	+68 Met klare lijnen Avec lignes claires +102	+51
	M2	1179	1741	1741	1911	2071	+680	+1645				
 FIXLINE LD173 ^{1,4} 96410 II (1) 306 x 1706mm	M1	1193	1519	1593	1913	2071	+680	+1645	1 x 	+55	+68 Met klare lijnen Avec lignes claires +102	+51
	M2	1301	1862	1862	2033	2193	+680	+1645				
 CADRAGE LD191 97410A II (1) ↔ 110 mm 506 x 726mm	M1	978	1303	1378	1698	1856	+668	+1779	1 x 	+55		+51
	M2	1089	1650	1650	1821	1981	+668	+1779				
 CADRAGE LD192 97410B II (1) 200 x 350mm	M1	1102	1428	1503	1823	1981	+668	+1779	1 x 	+55		+51
	M2	1213	1775	1775	1945	2105	+668	+1779				











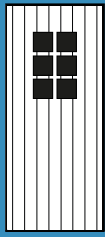

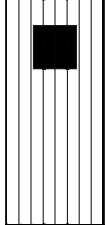
 Min. afmetingen bij inbouw. Bij **magnetude***: afhankelijk van de afmetingen A, B, C, D. Dim. mini pour pose en feuillure. En **magnetude*** : dépend des dimensions A, B, C, D.

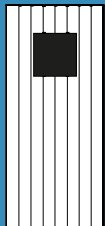
⁽¹⁾ infrezing **I** ook mogelijk | fraisage **I** aussi possible  p. 83

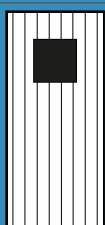
⁽²⁾ infrezing **II** ook mogelijk | fraisage **II** aussi possible  p. 83

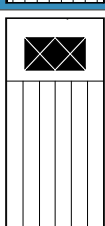
!!! SUPPLEMENT !!! magnetude

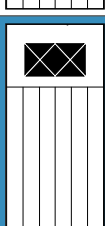
Voor PVC WIT SCHRIJNWERK:
basisprijs kolom RAL POEDER.
Pour CHASSIS PVC BLANC :
colonne RAL-POUDRE
comme prix de base.

						SUPPLEMENT per paneel par panneau		opties glas / options vitrage [ⓘ] p. 12-13				
M1 1 ZIJDE MOTIEF MOTIF 1 FACE M2 2 ZIJDEN MOTIEF MOTIF 2 FACES ▼ buitenaanzicht vue extérieure	PVC wit blanc • beige crème • 120 140 150	EXT folie filmé • INT wit blanc • beige crème	EXT folie filmé • INT folie filmé	RAL poeder poudre ⓘ p. 172-174	RAL pistool pistolet	SUPPL. magnetude		glas vormen • forme du vitrage	gelaagd 33.2 • feuilleté 33.2	sablé met klare board • sablé avec bord clair	coating 1,1	
						1 ZIJDE FACE • ⓘ p. 7-11	2 ZIJDEN FACES • ⓘ p. 7-11				met kern ISOL+, MU20 of HDP25 • avec âme ISOL+, MU20 ou HDP25	
	900x2100x37 mm	900x2100x36 mm	900x2100x36 mm	900x2100x36 mm	900x2100x36 mm	≤ 990x2190 mm	≤ 990x2190 mm					
 CADRAGE LD193 97410B II (1)	M1	1102	1428	1503	1823	1981	+668	+1779	1 x 	+55	+51	
	M2	1213	1775	1775	1945	2105	+668	+1779				Aantal lijnen even Nombres rainures paires
 VINTAGE LD201 98410A II (1)	M1	978	1303	1378	1698	1856	+654	+1779	1 x 	+55	+68	+51
	M2	1089	1650	1650	1821	1981	+654	+1779				
 VINTAGE LD202 98410B II (1)	M1	1102	1428	1503	1823	1981	+654	+1779	1 x 	+55	+68	+51
	M2	1213	1775	1775	1945	2105	+654	+1779				
 VINTAGE LD203 98410B II (1)	M1	1102	1428	1503	1823	1981	+654	+1779	1 x 	+55	+68	+51
	M2	1213	1775	1775	1945	2105	+654	+1779				
 COTTAGE LD211 98510A II (1)	M1	978	1303	1378	1698	1856	+656	+1779	1 x 	+55	+51	
	M2	1089	1650	1650	1821	1981	+656	+1779				→←→← 137 mm
 COTTAGE LD212 98510B II (1)	M1	1102	1428	1503	1823	1981	+656	+1779	1 x 	+55	+51	
	M2	1213	1775	1775	1945	2105	+656	+1779				Aantal lijnen even Nombres rainures paires













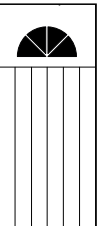

ⓘ Min. afmetingen bij inbouw. Bij **magnetude***: afhankelijk van de afmetingen A, B, C, D. Dim. mini pour pose en feuillure. En **magnetude*** : dépend des dimensions A, B, C, D.

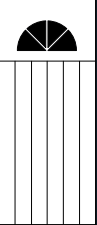
(1) infrezing **I** ook mogelijk | fraisage **I** aussi possible ⓘ p. 83

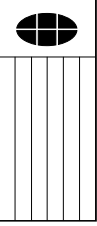
(2) infrezing **II** ook mogelijk | fraisage **II** aussi possible ⓘ p. 83

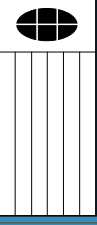
!!! SUPPLEMENT !!! magnetude

Voor PVC WIT SCHRIJNWERK: basisprijs kolom RAL POEDER. Pour CHASSIS PVC BLANC : colonne RAL-POUDRE comme prix de base.

		SUPPLEMENT per paneel par panneau						opties glas / options vitrage  p. 12-13			
M1 1 ZIJDE MOTIEF MOTIF 1 FACE M2 2 ZIJDEN MOTIEF MOTIF 2 FACES ▼ buitenaanzicht vue extérieure	PVC wit blanc • beige crème • 120 140 150	EXT folie filmé • INT wit blanc • beige crème	EXT folie filmé • INT folie filmé	RAL poeder poudre  p. 172-174	RAL pistool pistolet	SUPPL. magnetude		glas vormen • forme du vitrage	gelaagd 33.2 • feuilleté 33.2	sablé met klare board • sablé avec bord clair	coating 1,1
						1 ZIJDE FACE  p. 7-11	2 ZIJDEN FACES  p. 7-11				met kern ISOL+, MU20 of HDP25 • avec âme ISOL+, MU20 ou HDP25
		900x2100x37 mm	900x2100x36 mm	900x2100x36 mm	900x2100x36 mm	900x2100x36 mm	≤ 990x2190 mm	≤ 990x2190 mm			
 ENTOURAGE LD221 98610A II (1) ↔ 137 mm 620 x 484mm	M1	1066	1391	1466	1786	1944	+676	+1779	1x 	+65	+51
	M2	1174	1735	1735	1906	2066	+676	+1779			
 ENTOURAGE LD222 98610B II (1) 200 x 300mm	M1	1187	1513	1588	1908	2066	+676	+1779	1x 	+65	+51
	M2	1295	1857	1857	2027	2187	+676	+1779			
 LAMBRISSEGE LD231 98710A II (1) ↔ 137 mm 620 x 506mm	M1	1066	1391	1466	1786	1944	+680	+1779	1x 	+65	+51
	M2	1174	1735	1735	1906	2066	+680	+1779			
 LAMBRISSEGE LD232 98710B II (1) 200 x 300mm	M1	1195	1521	1596	1916	2074	+680	+1779	1x 	+65	+51
	M2	1305	1867	1867	2037	2197	+680	+1779			
 FALCON LD241 LD DESIGN A I (2) 150 x 300mm	M1	703	1060	1134	1240	1421	+463	+1196			
	M2	814	1406	1406	1352	1544	+463	+1196			
 VEGA LD251 LD DESIGN B I (2) 150 x 300mm	M1	703	1060	1134	1240	1421	+463	+1196			
	M2	814	1406	1406	1352	1544	+463	+1196			













 Min. afmetingen bij inbouw. Bij magnetude*: afhankelijk van de afmetingen A, B, C, D. Dim. mini pour pose en feuillure. En magnetude*: dépend des dimensions A, B, C, D.

(1) infrezing **I** ook mogelijk | fraissage **I** aussi possible  p. 83

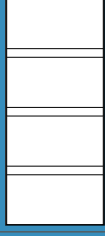
(2) infrezing **II** ook mogelijk | fraissage **II** aussi possible  p. 83

!!! SUPPLEMENT !!! magnetude

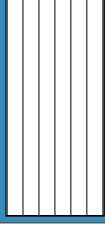
Voor PVC WIT SCHRIJNWERK: basisprijs kolom RAL POEDER. Pour CHASSIS PVC BLANC: colonne RAL-POUDRE comme prix de base.

							SUPPLEMENT per paneel par panneau		opties glas / options vitrage  p. 12-13						
M1 1 ZIJDE MOTIEF MOTIF 1 FACE M2 2 ZIJDEN MOTIEF MOTIF 2 FACES	PVC wit blanc • beige crème • 120 140 150	EXT folie filmé • INT wit blanc • beige crème	EXT folie filmé • INT folie filmé	RAL poeder poudre •  p. 172-174	RAL pistool pistolet	SUPPL. magnetude		glas vormen • forme du vitrage	gelaagd 33.2 • feuilleté 33.2	sablé met klare board • sablé avec bord clair	coating 1,1				
						1 ZIJDE FACE  p. 7-11	2 ZIJDEN FACES  p. 7-11				met kern ISOL+ , MU20 of HDP25 • avec âme ISOL+ , MU20 ou HDP25				
▼ buitenaanzicht vue extérieure							900x2100x37 mm	900x2100x36 mm	900x2100x36 mm	900x2100x36 mm	900x2100x36 mm	≤ 990x2190 mm	≤ 990x2190 mm		
 ARIANE LD261 LD DESIGN C I ⁽²⁾  150 x 300mm	M1	703	1060	1134	1240	1421	+463	+1196							
	M2	814	1406	1406	1352	1544	+463	+1196							
 SATURN LD271 LD DESIGN D I ⁽²⁾  150 x 300mm	M1	703	1060	1134	1240	1421	+463	+1196							
	M2	814	1406	1406	1352	1544	+463	+1196							
 ATLAS LD281 LD DESIGN E I ⁽²⁾  150 x 300mm	M1	703	1060	1134	1240	1421	+463	+1196							
	M2	814	1406	1406	1352	1544	+463	+1196							
 TITAN LD291 LD DESIGN F I ⁽²⁾  150 x 300mm	M1	703	1060	1134	1240	1421	+463	+1196							
	M2	814	1406	1406	1352	1544	+463	+1196							
	M1														
	M2														
	M1														
	M2														







 Min. afmetingen bij inbouw. Bij **magnetude**[®]: afhankelijk van de afmetingen A, B, C, D. Dim. mini pour pose en feuillure. En **magnetude**[®] : dépend des dimensions A, B, C, D.

⁽¹⁾ infrezing **I** ook mogelijk | fraissage **I** aussi possible  p. 83

⁽²⁾ infrezing **II** ook mogelijk | fraissage **II** aussi possible  p. 83



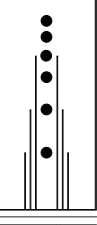

**!!! SUPPLEMENT !!!
magnetude**

Voor PVC WIT SCHRIJNWERK:
basisprijs kolom RAL POEDER.
Pour CHASSIS PVC BLANC :
colonne RAL-POUDRE
comme prix de base.

						Belangrijk Attention			
M1 1 ZIJDE MOTIEF MOTIF 1 FACE M2 2 ZIJDEN MOTIEF MOTIF 2 FACES		PVC wit blanc • beige crème • 120 140 150	EXT folie filmé • INT wit blanc • beige crème	EXT folie filmé • INT folie filmé	RAL poeder poudre p. 172-174	RAL pistool pistolet	SUPPL. MAGNETUDE		EQUILINE altijd toujours glas vormen • forme du vitrage
							1 ZIJDE FACE p. 7-11	2 ZIJDEN FACES p. 7-11	
▼ buitenaanzicht vue extérieure		900x2100x37 mm	900x2100x36 mm	900x2100x36 mm	900x2100x36 mm	900x2100x36 mm	≤ 990x2190 mm	≤ 990x2190 mm	
 TOSCANE LD301 EQUILINE 1 II E 206 x 1606mm	M1	881	1178	1231	1506	1770			acide 33.2 + 1.1 coating
	M2	881	1377	1473	1613	1773			1x ■
 LAZIO LD311 EQUILINE 2 II E 206 x 1606mm	M1	881	1178	1231	1506	1770			acide 33.2 + 1.1 coating
	M2	881	1377	1473	1613	1773			1x ■
 AMALFI LD321 EQUILINE 3 I E 310 x 1606mm	M1	881	1178	1231	1506	1770			acide 33.2 + 1.1 coating
	M2	881	1377	1473	1613	1773			1x ■
 APULIA LD331 EQUILINE 4 I E 597 x 1592mm	M1	881	1178	1231	1506	1770			acide 33.2 + 1.1 coating
	M2	881	1377	1473	1613	1773			1x ■
 ABRUZZO LD341 EQUILINE 5 I E 466 x 1606mm	M1	881	1178	1231	1506	1770			acide 33.2 + 1.1 coating
	M2	881	1377	1473	1613	1773			1x ■
 PUGLIA LD351 EQUILINE 6 I E 320 x 1606mm	M1	881	1178	1231	1506	1770			acide 33.2 + 1.1 coating
	M2	881	1377	1473	1613	1773			1x ■
							!!! SUPPLEMENT !!! magnetude Voor PVC WIT SCHRUIJWERK: basisprijs kolom RAL POEDER. Pour CHASSIS PVC BLANC : colonne RAL POUDRE comme prix de base.		

(1) infrezing **I** ook mogelijk | fraisage **I** aussi possible ⓘ p. 83

(2) infrezing **II** ook mogelijk | fraisage **II** aussi possible ⓘ p. 83

							Belangrijk Attention			
M1 1 ZIJDE MOTIEF MOTIF 1 FACE M2 2 ZIJDEN MOTIEF MOTIF 2 FACES ▼ buitenaanzicht vue extérieure		PVC wit blanc • beige crème • 120 140 150	EXT folie filmé • INT wit blanc • beige crème	EXT folie filmé • INT folie filmé	RAL poeder poudre p. 172-174	RAL pistool pistolet	SUPPL. MAGNETUDE		EQUILINE altijd toujours	
		900x2100x37 mm	900x2100x36 mm	900x2100x36 mm	900x2100x36 mm	900x2100x36 mm	1 ZIJDE FACE p. 7-11	2 ZIJDEN FACES p. 7-11	glas vormen • forme du vitrage	• Thermimax 33 • Acide 33.2 + 1.1 coating • Inbouwpaneel pose en feuillure
 UMBRIA LD361 EQUILINE 7 I E 206 x 1606mm	M1	881	1178	1231	1506	1770			1 x ■	acide 33.2 + 1.1 coating
	M2	881	1377	1473	1613	1773				
 AOSTA LD371 EQUILINE 8 I E 206 x 1606mm	M1	881	1178	1231	1506	1770			1 x ■	acide 33.2 + 1.1 coating
	M2	881	1377	1473	1613	1773				
 LIGURIA LD381 EQUILINE 9 I E 366 x 1606mm	M1	881	1178	1231	1506	1770			1 x ■	acide 33.2 + 1.1 coating
	M2	881	1377	1473	1613	1773				
 CALABRIA LD391 EQUILINE 10 I E 206 x 1606mm	M1	881	1178	1231	1506	1770			1 x ■	acide 33.2 + 1.1 coating
	M2	881	1377	1473	1613	1773				

infrezing - fraissage
TYPE **I**

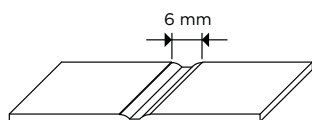

infrezing - fraissage
TYPE **II**

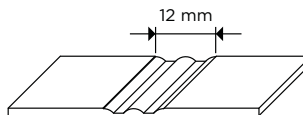

⁽¹⁾ infrezing **I** ook mogelijk | fraissage **I** aussi possible ⓘ p. 83

⁽²⁾ infrezing **II** ook mogelijk | fraissage **II** aussi possible ⓘ p. 83

**!!! SUPPLEMENT !!!
magnetude**

Voor PVC WIT SCHRUIJWERK:
basisprijs kolom RAL POEDER.
Pour CHASSIS PVC BLANC :
colonne RAL POUDRE
comme prix de base.

supplement - DECO GLAS | VITRAGES DÉCO

LORD LD051	TASTE LD071	LD101 CADENS	RITMO LD111
D178B + € 807	D178B + € 807	D178B + € 807	D178B + € 807

supplement - GEDEELTE GEZANDSTRAALD | SABLÉ PARTIELLEMENT

PRILINE LD131 2 3 4	BALINE LD141	FREELINE LD151 2 3 4	FIXLINE LD171 2 3 4
MKL* + € 104	MKL* + € 104	MKL* + € 104	MKL* + € 104

* Met klare lijnen
Avec ligne clair

* Met klare lijnen
Avec ligne clair

* Met klare lijnen
Avec ligne clair

* Met klare lijnen
Avec ligne clair

frager.

CREATORS OF DOORS

mondial



Informatie | Information

Kernen • Ames	MU 20	ISOL + 22	HDP 25	THERMI- MAX 33	FLAMEBOARD 200 + (a)	ISOMIX 37	AMAC 38 (b)	ISOMIX 40	ISOMIX 43
Totale dikte • Epaisseur totale ALU/PVC	23/24	25/26	28/29	36/37	38/39	40/41	41/42	43/44	46/47
Indien beglaasd meerprijs triple glas • Si vitré, toujours rajouter plus-value triple vitrage	-	-	-	-	-	X	-	X	X
Indien beglaasd coating 1.1 standaard • Si vitré, le vitrage sera d'office avec 1,1	-	-	-	X	-	X	-	X	X
U-waarde • Valeur U W/m ² K	3,21	1,5	1,71	1,1	1,3	0,53	2,38	0,51	0,49
RW - dB Geluidswerend, enkel onbeglaasd • Acoustique, uniquement non-vitré		26		30		28	41	28	28

 PVC wit of beige
 PVC blanc ou crème

Formaat • Format	MU 20	ISOL + 22	HDP 25	THERMI- MAX 33	FLAMEBOARD 200 + (a)	ISOMIX 37	AMAC 38 (b)	ISOMIX 40	ISOMIX 43
900 x 2100	105	0	71	std.	-	125	314	135	146
1050 x 2200	-	92	-	90	-	179	-	189	206

 FOLIE 1 zijdig of 2 zijdig
 FILME 1 face ou 2 faces

Formaat • Format	MU 20	ISOL + 22	HDP 25	THERMI- MAX 33	FLAMEBOARD 200 + (a)	ISOMIX 37	AMAC 38 (b)	ISOMIX 40	ISOMIX 43
900 x 2100	105	0	71	std.	-	125	314	135	146
1050 x 2200	-	92	-	90	-	179	-	189	206
1150 x 2500	-	-	-	422	-	422	-	422	422
1150 x 3000	-	-	-	-	-	481	-	481	481

 RAL poeder of pistool
 RAL poudre ou pistolet

Formaat • Format	MU 20	ISOL + 22	HDP 25	THERMI- MAX 33	FLAMEBOARD 200 + (a)	ISOMIX 37	AMAC 38 (b)	ISOMIX 40	ISOMIX 43
900 x 2100	105	0	71	std.	166	125	314	135	146
1050 x 2200	-	92	-	90	-	179	-	189	206
1250 x 2500	-	-	-	362	-	362	-	362	362
1500 x 3000	-	-	-	-	-	481	-	481	481















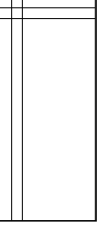

magnetude
1 ZIJDE | FACE
2 ZIJDEN | FACES

Formaat • Format	PVC	1Z folie filmé	2Z folie filmé	RAL poeder poudre	RAL pistool pistolet	PVC	1Z folie filmé	2Z folie filmé	RAL poeder poudre	RAL pistool pistolet
990 x 2190	0	0	0	0	0	0	0	0	0	0
1240 x 2490	272	-	-	272	272	427	-	-	427	427
1140 x 2490	-	272	272	-	-	-	427	427	-	-
1140 x 2990	-	836	836	-	-	-	1226	1226	-	-
1490 x 2990	543	-	-	543	543	851	-	-	851	851

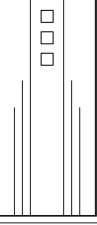
Formaten groter dan 1050x2200 mm zijn enkel leverbaar in België en Luxemburg. | Formats plus grands que 1050x2200 mm ne sont livrables qu'en Belgique et Luxembourg.

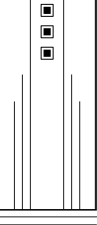
(a) enkel in combinatie met RAL poeder en onbeglaasd | uniquement possible en RAL poudre et non-vitré

(b) enkel onbeglaasd | uniquement non-vitré



		SUPPLEMENT per paneel par panneau						opties glas / options vitrage  p. 12-13				
M1 1 ZIJDE MOTIEF MOTIF 1 FACE M2 2 ZIJDEN MOTIEF MOTIF 2 FACES ▼ buitenaanzicht vue extérieure	PVC wit blanc • beige crème • 120 140 150	EXT folie filmé • INT wit blanc • beige crème	EXT folie filmé • INT folie filmé	RAL poeder poudre •  p. 172-174	RAL pistool pistolet	SUPPL. magnetude		glas vormen • forme du vitrage	gelaagd 33.2 • feuilleté 33.2	sablé met klare boord • sablé avec bord clair	coating 1,1	
						1 ZIJDE FACE  p. 7-11	2 ZIJDEN FACES  p. 7-11				met kern ISOL+ , MU20 of HDP25 • avec âme ISOL+ , MU20 ou HDP25	
 PRESTO MO011 3 131  (4) 190 x 1590mm	M1	579	1087	1161	1276	1498	+463	+1257				
	M2	690	1284	1285	1401	1622	+463	+1257				
 PRESTO MO012 4 13110  (4) 190 x 1590mm	M1	1277	1609	1683	1799	2019	+649	+1840	1x 	+55		+51
	M2	1385	1808	1809	1925	2150	+649	+1840				
 ISIS MO021 2 141  (4) 200 x 200mm	M1	579	1087	1161	1276	1498	+463	+1257				
	M2	690	1284	1285	1401	1622	+463	+1257				
 MODE MO031 146  (4) 190 x 590mm	M1	579	1087	1161	1276	1498	+463	+1257				
	M2	690	1284	1285	1401	1622	+463	+1257				
 MODE MO032 14610  (4) 190 x 590mm	M1	926	1641	1715	1831	2052	+637	+1840	1x 	+55		+51
	M2	1037	1826	1826	1940	2158	+637	+1840				
 LINEA MO041 162  (4) 98 mm 150 x 300mm	M1	579	1087	1161	1276	1498	+463	+1257				
	M2	690	1284	1285	1401	1622	+463	+1257				

 Min. afmetingen bij inbouw. Bij **magnetude***: afhankelijk van de afmetingen A, B, C, D.
Dim. mini pour pose en feuillure. En **magnetude*** : dépend des dimensions A, B, C, D.

(4) infrezing  ook mogelijk | fraisage  aussi possible  p. 90

**!!! SUPPLEMENT !!!
magnetude**

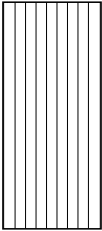
Voor PVC WIT SCHRIJNWERK:
basisprijs kolom RAL POEDER.
Pour CHASSIS PVC BLANC :
colonne RAL POUDRE
comme prix de base.

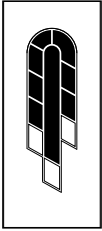
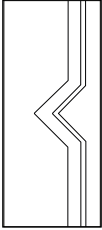
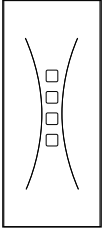
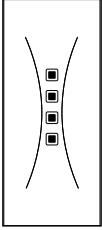















						SUPPLEMENT per paneel par panneau		opties glas / options vitrage ④ p. 12-13				
M1 1 ZIJDE MOTIEF MOTIF 1 FACE M2 2 ZIJDEN MOTIEF MOTIF 2 FACES ▼ buitenaanzicht vue extérieure		PVC wit blanc • beige crème 120 140 150	EXT folie filmé • INT wit blanc • beige crème	EXT folie filmé • INT folie filmé	RAL poeder poudre ④ p. 172-174	RAL pistool pistolet	SUPPL. magnetude		glas vormen • forme du vitrage	gelaagd 33.2 • feuilleté 33.2	sablé met klare board • sablé avec bord clair	coating 1,1
		1 ZIJDE FACE ④ p. 7-11	2 ZIJDEN FACES ④ p. 7-11	≤ 990x2190 mm	≤ 990x2190 mm	met kern ISOL+, MU20 of HDP25 • avec âme ISOL+, MU20 ou HDP25						
 GALA MO051 621 III ↔ 98 mm 150 x 300mm	M1	579	1087	1161	1276	1498	+463	+1257				
	M2	690	1284	1285	1401	1622	+463	+1257				
 ROSAMAR MO061 19110 III (4) 697 x 1546mm	M1	1031	1601	1675	1790	2011	+606	+1742	1x ▼	+65	+108	+51
	M2	1154	1807	1807	1922	2142	+727	+1742				
 JUNIOR MO071 95010 III (4) 526 x 1586mm	M1	1234	1803	1877	1992	2213	+714	+1840	1x ♣	+65		+51
	M2	1356	2008	2008	2095	2344	+1376	+2752				
 MADISON MO081 211 III (4) 550 x 681mm	M1	579	1087	1161	1276	1498	+463	+1257				
	M2	690	1284	1285	1401	1622	+463	+1257				
 ORAK MO091 217 III (4) 545 x 1473mm	M1	579	1087	1161	1276	1498	+463	+1257				
	M2	690	1284	1285	1401	1622	+463	+1257				
 ORAK MO092 21710 III (4) 545 x 1473mm	M1	943	1513	1587	1702	1923	+637	+1706	1x ■	+55		+51
	M2	1055	1708	1708	1823	2043	+637	+1706				

④ Min. afmetingen bij inbouw. Bij magnetude*: afhankelijk van de afmetingen A, B, C, D.
Dim. mini pour pose en feuillure. En magnetude*: dépend des dimensions A, B, C, D.

④ infrezing IV ook mogelijk | fraisage IV aussi possible ④ p. 90

!!! SUPPLEMENT !!! magnetude

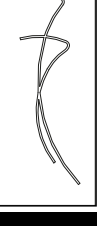
Voor PVC WIT SCHRIJNWERK: basisprijs kolom RAL POEDER.
Pour CHASSIS PVC BLANC: colonne RAL POUDDRE comme prix de base.

						SUPPLEMENT per paneel par panneau		opties glas / options vitrage  p. 12-13				
M1 1 ZIJDE MOTIEF MOTIF 1 FACE M2 2 ZIJDEN MOTIEF MOTIF 2 FACES ▼ buitenaanzicht vue extérieure	PVC wit blanc • beige crème • 120 140 150	EXT folie filmé • INT wit blanc • beige crème	EXT folie filmé • INT folie filmé	RAL poeder poudre •  p. 172-174	RAL pistool pistolet	SUPPL. magnetude		glas vormen • forme du vitrage	gelaagd 33.2 • feuilleté 33.2	sablé met klare board • sablé avec bord clair	coating 1,1	
						1 ZIJDE FACE •  p. 7-11	2 ZIJDEN FACES •  p. 7-11				met kern ISOL+ , MU20 of HDP25 • avec âme ISOL+ , MU20 ou HDP25	
		900x2100x37 mm	900x2100x36 mm	900x2100x36 mm	900x2100x36 mm	900x2100x36 mm	≤ 990x2190 mm	≤ 990x2190 mm				
 SARA MO101 2 25310  (4) 703 x 703mm	M1	943	1513	1587	1702	1923	+668	+1742	1x ▼	+65	+108	+51
	M2	1055	1708	1708	1823	2043	+668	+1742				
 SARA MO103 4 25315  (4) 525 x 525mm	M1	943	1513	1587	1702	1923	+646	+1742	1x ▼	+65	+108	+51
	M2	1055	1708	1708	1823	2043	+646	+1742				
 LEE MO111 2 25420  (4) 514 x 1660mm	M1	1254	1642	1715	1828	2050	+846	+2289	2x ◐	+130	+216	+102
	M2	1363	1840	1840	1956	2179	+846	+2289				
 OCTRO MO121 2 63710  (4) 411 x 1756mm	M1	1490	1957	1962	2079	2302	+1393	+2786	1x ♣	+65		+51
	M2	1597	2003	2087	2205	2429	+1393	+2786				
 ENNIO MO131 2 63830  (4) 411 x 1411mm	M1	1206	1673	1678	1834	1994	+902	+2605	3x ■	+165		+153
	M2	1317	1723	1807	1960	2124	+902	+2605				
 LIUNO MO141 2 691  (4) 562 x 1779mm	M1	579	1087	1161	1276	1498	+463	+1257				
	M2	690	1284	1285	1401	1622	+463	+1257				

 Min. afmetingen bij inbouw. Bij **magnetude***: afhankelijk van de afmetingen A, B, C, D. Dim. mini pour pose en feuillure. En **magnetude*** : dépend des dimensions A, B, C, D.

⁽⁴⁾ infrezing  ook mogelijk | fraisage  aussi possible  p. 90

**!!! SUPPLEMENT !!!
magnetude**

Voor PVC WIT SCHRIJNWERK:
basisprijs kolom RAL POEDER.
Pour CHASSIS PVC BLANC :
colonne RAL POUDRE
comme prix de base.

SUPPLEMENT per paneel | par panneau

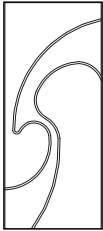
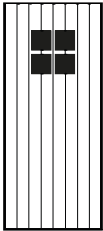
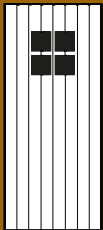
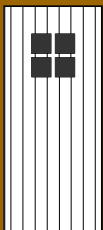
M1 1 ZIJDE MOTIEF MOTIF 1 FACE M2 2 ZIJDEN MOTIEF MOTIF 2 FACES ▼ buitenaanzicht vue extérieure	PVC wit blanc • beige crème • 120 140 150	EXT folie filmé • INT wit blanc • beige crème	EXT folie filmé • INT folie filmé	RAL poeder poudre ⓘ p. 172-174	RAL pistool pistolet	SUPPL. magnetude		opties glas / options vitrage ⓘ p. 12-13			
						1 ZIJDE FACE ⓘ p. 7-11	2 ZIJDEN FACES ⓘ p. 7-11	glas vormen • forme du vitrage	gelaagd 33.2 • feuilleté 33.2	sablé met klare boord • sablé avec bord clair	coating 1,1
											met kern ISOL+ , MU20 of HDP25 • avec âme ISOL+ , MU20 ou HDP25
	M1	579	1087	1161	1276	1498	+463	+1257			
	M2	690	1284	1285	1401	1622	+463	+1257			
	M1	1097	1666	1740	1855	2076	+654	+1840	1x ■	+55	+51
	M2	1205	1857	1857	1944	2193	+654	+1840			
Aantal lijnen oneven Nombres rainures impaires											
	M1	1218	1788	1861	1976	2198	+654	+1840	1x ■	+55	+51
	M2	1326	1979	1979	2066	2315	+654	+1840			
Aantal lijnen oneven Nombres rainures impaires											
	M1	1218	1788	1861	1976	2198	+654	+1840	1x ■	+55	+51
	M2	1326	1979	1979	2066	2315	+654	+1840			
Aantal lijnen even Nombres rainures paires											

infrezing - fraisage
TYPE III
(4)

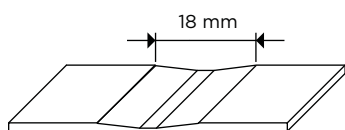

(4)

infrezing - fraisage
TYPE IV
IV [6, 8, 10, 12, 14, 16, 18, 20]

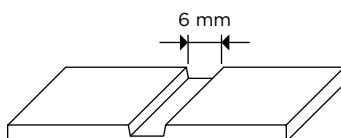

IV [6]

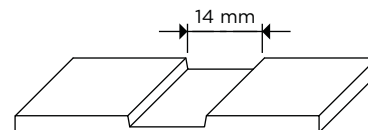

IV [14]

Min. afmetingen bij inbouw. Bij **magnetude***: afhankelijk van de afmetingen A, B, C, D.
Dim. mini pour pose en feuillure. En **magnetude***: dépend des dimensions A, B, C, D.

(4) infrezing **IV** ook mogelijk | fraisage **IV** aussi possible ⓘ p. 90

SUPPLEMENT per paneel | par panneau

<p>M1 1 ZIJDE MOTIEF MOTIF 1 FACE</p> <p>M2 2 ZIJDEN MOTIEF MOTIF 2 FACES</p> <p>▼ buitenaanzicht vue extérieure</p>	<p>PVC wit blanc • beige crème • 120 140 150</p>	<p>EXT folie filmé • INT wit blanc • beige crème</p>	<p>EXT folie filmé • INT folie filmé</p>	<p>RAL poeder poudre • p. 172-174</p>	<p>RAL pistool pistolet</p>	SUPPL. magnetude		opties glas / options vitrage ⓘ p. 12-13				
						1 ZIJDE FACE • p. 7-11	2 ZIJDEN FACES • p. 7-11	glas vormen • forme du vitrage	gelaagd 33.2 • feuilleté 33.2	sablé met klare boord • sablé avec bord clair	coating 1,1 • met kern ISOL+ , MU20 of HDP25 • avec âme ISOL+ , MU20 ou HDP25	
						≤ 990x2190 mm	≤ 990x2190 mm					
<p>PLATO MO171 MO DESIGN A III (4)</p> <p>150 x 300mm</p>	M1	703	1088	1162	1277	1499	+463	+1257				
	M2	814	1290	1290	1408	1630	+463	+1257				
<p>KANT MO181 MO DESIGN B III (4)</p> <p>150 x 300mm</p>	M1	703	1088	1162	1277	1499	+463	+1257				
	M2	814	1290	1290	1408	1630	+463	+1257				
<p>ERASMUS MO191 MO DESIGN C III (4)</p> <p>150 x 300mm</p>	M1	703	1088	1162	1277	1499	+463	+1257				
	M2	814	1290	1290	1408	1630	+463	+1257				
<p>SPINOZA MO201 MO DESIGN G III (4)</p> <p>150 x 300mm</p>	M1	703	1088	1162	1277	1499	+463	+1257				
	M2	814	1290	1290	1408	1630	+463	+1257				
<p>SARTRE MO211 MO DESIGN H III (4)</p> <p>150 x 300mm</p>	M1	703	1088	1162	1277	1499	+463	+1257				
	M2	814	1290	1290	1408	1630	+463	+1257				
<p>FREUD MO221 MO DESIGN I III (4)</p> <p>150 x 300mm</p>	M1	703	1088	1162	1277	1499	+463	+1257				
	M2	814	1290	1290	1408	1630	+463	+1257				

Min. afmetingen bij inbouw. Bij **magnetude***: afhankelijk van de afmetingen A, B, C, D.
Dim. mini pour pose en feuillure. En **magnetude***: dépend des dimensions A, B, C, D.

(4) infrezing **IV** ook mogelijk | fraisage **IV** aussi possible ⓘ p. 90

**!!! SUPPLEMENT !!!
magnetude**

Voor PVC WIT SCHRIJNWERK:
basisprijs kolom RAL POEDER.
Pour CHASSIS PVC BLANC:
colonne RAL POUDRE
comme prix de base.



Informatie | Information

Kernen • Ames	MU 20	ISOL + 22	HDP 25	THERMI- MAX 33	FLAMEBOARD 200 + (a)	ISOMIX 37	AMAC 38 (b)	ISOMIX 40	ISOMIX 43
Totale dikte • Epaisseur totale ALU/PVC	23/24	25/26	28/29	36/37	38/39	40/41	41/42	43/44	46/47
Indien beglaasd meerprijs triple glas • Si vitré, toujours rajouter plus-value triple vitrage	-	-	-	-	-	X	-	X	X
Indien beglaasd coating 1.1 standaard • Si vitré, le vitrage sera d'office avec 1,1	-	-	-	X	-	X	-	X	X
U-waarde • Valeur U W/m ² K	3,21	1,5	1,71	1,1	1,3	0,53	2,38	0,51	0,49
RW - dB Geluidswerend, enkel onbeglaasd • Acoustique, uniquement non-vitré		26		30		28	41	28	28

PVC wit of beige
PVC blanc ou crème

Formaat • Format	MU 20	ISOL + 22	HDP 25	THERMI- MAX 33	FLAMEBOARD 200 + (a)	ISOMIX 37	AMAC 38 (b)	ISOMIX 40	ISOMIX 43
900 x 2100	105	0	71	std.	-	125	314	135	146

FOLIE 1 zijdig of 2 zijdig
FILME 1 face ou 2 faces

Formaat • Format	MU 20	ISOL + 22	HDP 25	THERMI- MAX 33	FLAMEBOARD 200 + (a)	ISOMIX 37	AMAC 38 (b)	ISOMIX 40	ISOMIX 43
900 x 2100	105	0	71	std.	-	125	314	135	146
1050 x 2200	-	92	-	90	-	179	-	189	206

RAL poeder of pistool
RAL poudre ou pistolet

Formaat • Format	MU 20	ISOL + 22	HDP 25	THERMI- MAX 33	FLAMEBOARD 200 + (a)	ISOMIX 37	AMAC 38 (b)	ISOMIX 40	ISOMIX 43
900 x 2100	105	0	71	std.	166	125	314	135	146
1050 x 2200	-	92	-	90	-	179	-	189	206

(a) enkel in combinatie met RAL poeder en onbeglaasd | uniquement possible en RAL poudre et non-vitré

(b) enkel onbeglaasd | uniquement non-vitré

SUPPLEMENT per paneel | par panneau

<p>M1 1 ZIJDE MOTIEF MOTIF 1 FACE</p> <p>M2 2 ZIJDEN MOTIEF MOTIF 2 FACES</p> <p>▼ buitenaanzicht vue extérieure</p>		<p>PVC wit blanc • beige crème 120 140 150</p>	<p>EXT folie filmé • INT wit blanc • beige crème</p>	<p>EXT folie filmé • INT folie filmé</p>	<p>RAL poeder poudre p. 172-174</p>	<p>RAL pistool pistolet</p>	SUPPL. magnetude		opties glas / options vitrage p. 12-13			
							1 ZIJDE FACE	2 ZIJDEN FACES	<p>glas vormen • forme du vitrage</p>	<p>gelaagd 33.2 • feuilleté 33.2</p>	<p>sablé met klare board • sablé avec bord clair</p>	<p>coating 1,1 • met kern ISOL+, MU20 of HDP25 • avec âme ISOL+, MU20 ou HDP25</p>
							p. 7-11	p. 7-11				
<p>ELEGANCE TO011 510</p> <p> 580 x 1625mm</p>	M1	630	1215	1289	1402	1581						
	M2	738	1595	1595	1732	1965						
<p>ELEGANCE TO012 1110</p> <p> 580 x 1625mm</p>	M1	1044	1651	1724	1838	2015			1 x	+65	+118	+51
	M2	1243	1931	1931	2049	2279			SG p. 99 KK p. 99			
<p>ELEGANCE TO013 515</p> <p> 530 x 1640mm</p>	M1	630	1215	1289	1402	1581						
	M2	738	1595	1595	1732	1965						
<p>ELEGANCE TO014 1115</p> <p> 530 x 1640mm</p>	M1	1044	1651	1724	1838	2015			1 x	+65	+118	+51
	M2	1243	1931	1931	2049	2279			SG p. 99 KK p. 99			
<p>MONZA TO021 530</p> <p> 620 x 1640mm</p>	M1	630	1214	1289	1402	1581						
	M2	738	1595	1595	1732	1965						
<p>MONZA TO022 1320</p> <p> 620 x 1640mm</p>	M1	1163	1727	1801	1915	2095			2 x	+110	+137	+102
	M2	1360	2002	2002	2118	2347			SG p. 100 KK p. 99			
							<p>!!! SUPPLEMENT !!! magnetude</p> <p>Voor PVC WIT SCHRUIJWERK: basisprijs kolom RAL POEDER. Pour CHASSIS PVC BLANC : colonne RAL POUDRE comme prix de base.</p>					

SUPPLEMENT per paneel | par panneau

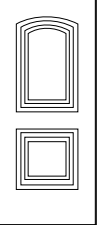
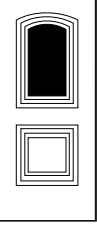
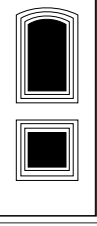
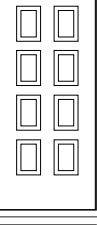
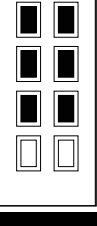
M1 1 ZIJDE MOTIEF MOTIF 1 FACE M2 2 ZIJDEN MOTIEF MOTIF 2 FACES ▼ buitenaanzicht vue extérieure		PVC wit blanc • beige crème • 120 140 150	EXT folie filmé • INT wit blanc • beige crème	EXT folie filmé • INT folie filmé	RAL poeder poudre ⓘ p. 172-174	RAL pistool pistolet	SUPPL. magnetude		opties glas / options vitrage ⓘ p. 12-13			
							1 ZIJDE FACE ⓘ p. 7-11	2 ZIJDEN FACES ⓘ p. 7-11	glas vormen • forme du vitrage	gelaagd 33.2 • feuilleté 33.2	sablé met klare boord • sablé avec bord clair	coating 1,1 met kern ISOL+ , MU20 of HDP25 • avec âme ISOL+ , MU20 ou HDP25
							≤ 990x2190 mm	≤ 990x2190 mm				
 MONZA TO023 1340 620 x 1640mm	M1	1360	1994	2067	2180	2355			4 x ■	+220	+274	+204
	M2	1560	2276	2276	2396	2626			KK p. 99			
 ROYAL TO031 540 605 x 1622mm	M1	630	1215	1289	1402	1581						
	M2	738	1595	1595	1732	1965						
 ROYAL TO032 1410 605 x 1622mm	M1	1044	1651	1724	1838	2015			1 x ■	+55	+118	+51
	M2	1153	2032	2032	2173	2404			SG p. 100 KK p. 99 RO p. 100			
 ROYAL TO033 1420 605 x 1622mm	M1	1243	1851	1923	2036	2214			2 x ■	+110	+186	+102
	M2	1351	2228	2228	2371	2603			KK p. 99 RO p. 100			
 VIKTORIA TO041 580 600 x 1640mm	M1	630	1215	1289	1402	1581						
	M2	738	1595	1595	1732	1965						
 VIKTORIA TO042 1860 600 x 1640mm	M1	1515	2013	2087	2203	2391			6 x ■	+330	+411	+306
	M2	1712	2284	2284	2395	2622			KK p. 99			
							!!! SUPPLEMENT !!! magnetude Voor PVC WIT SCHRUNWERK: basisprijs kolom RAL POEDER. Pour CHASSIS PVC BLANC : colonne RAL POUDRE comme prix de base.					

SUPPLEMENT per paneel | par panneau

<p>M1 1 ZIJDE MOTIEF MOTIF 1 FACE</p> <p>M2 2 ZIJDEN MOTIEF MOTIF 2 FACES</p> <p>▼ buitenaanzicht vue extérieure</p>		<p>PVC wit blanc • beige crème • 120 140 150</p>	<p>EXT folie filmé • INT wit blanc • beige crème</p>	<p>EXT folie filmé • INT folie filmé</p>	<p>RAL poeder poudre • p. 172-174</p>	<p>RAL pistool pistolet</p>	<p>SUPPL. magnetude</p>		<p>opties glas / options vitrage ⓘ p. 12-13</p>			
							<p>1 ZIJDE FACE • p. 7-11</p>	<p>2 ZIJDEN FACES • p. 7-11</p>	<p>glas vormen • forme du vitrage</p>	<p>gelaagd 33.2 • feuilleté 33.2</p>	<p>sablé met klare boord • sablé avec bord clair</p>	<p>coating 1,1 met kern ISOL+, MU20 of HDP25 • avec âme ISOL+, MU20 ou HDP25</p>
							<p>≤ 990x2190 mm</p>	<p>≤ 990x2190 mm</p>				
 VIKTORIA TO043 1880 600 x 1640mm	M1	1661	2163	2238	2354	2540			8 x ■	+440	+548	+408
	M2	1857	2551	2551	2671	2901			KK p. 99			
 NIKITA TO051 630 600 x 1590mm	M1	630	1215	1289	1402	1581						
	M2	738	1595	1595	1732	1965						
 NIKITA TO052 2310 600 x 1590mm	M1	1011	1579	1653	1768	1949			1 x ♣	+65	+118	+51
	M2	1210	1858	1858	1972	2201			SG p. 100 KK p. 99			
 NIKITA TO053 2370 600 x 1590mm	M1	1539	2068	2143	2259	2443			6 x ■ 1 x ♣	+395	+529	+357
	M2	1736	2343	2343	2455	2683			SG p. 100 KK p. 99			
 CHATEAU TO061 650 590 x 1720mm	M1	630	1215	1289	1402	1581						
	M2	738	1595	1595	1732	1965						
 CHATEAU TO062 2510 590 x 1720mm	M1	1044	1651	1724	1838	2015			1 x ■	+55	+118	+51
	M2	1153	2032	2032	2173	2404			SG p. 100 KK p. 99			
							<p>!!! SUPPLEMENT !!! magnetude</p> <p>Voor PVC WIT SCHRUIJWERK: basisprijs kolom RAL POEDER. Pour CHASSIS PVC BLANC : colonne RAL POUDRE comme prix de base.</p>					

SUPPLEMENT per paneel | par panneau

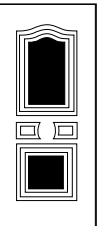
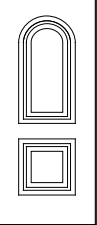
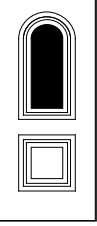
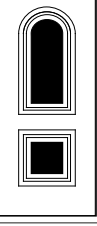
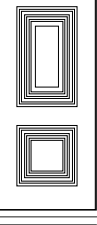
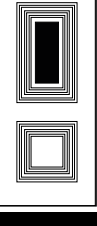
M1 1 ZIJDE MOTIEF MOTIF 1 FACE M2 2 ZIJDEN MOTIEF MOTIF 2 FACES ▼ buitenaanzicht vue extérieure	PVC wit blanc • beige crème • 120 140 150	EXT folie filmé • INT wit blanc • beige crème	EXT folie filmé • INT folie filmé	RAL poeder poudre ⓘ p. 172-174	RAL pistool pistolet	SUPPL. magnetude		opties glas / options vitrage ⓘ p. 12-13				
						1 ZIJDE FACE ⓘ p. 7-11	2 ZIJDEN FACES ⓘ p. 7-11	glas vormen • forme du vitrage	gelaagd 33.2 • feuilleté 33.2	sablé met klare boord • sablé avec bord clair	coating 1,1 • met kern ISOL+, MU20 of HDP25 • avec âme ISOL+, MU20 ou HDP25	
						≤ 990x2190 mm	≤ 990x2190 mm					
 CHATEAU TO063 2520 590 x 1720mm	M1	1243	1851	1923	2036	2214			2 x ■	+110	+186	+102
	M2	1351	2228	2228	2371	2603						
 PAVERA TO071 670 530 x 1690mm	M1	630	1215	1289	1402	1581						
	M2	738	1595	1595	1732	1965						
 PAVERA TO072 2710 530 x 1690mm	M1	1044	1651	1724	1838	2015			1 x ◐	+55	+108	+51
	M2	1153	2032	2032	2173	2404			SG p. 100 KK p. 99 RO p. 100			
 PAVERA TO073 2720 530 x 1690mm	M1	1243	1851	1923	2036	2214			1 x ■ 1 x ◐	+110	+177	+102
	M2	1351	2228	2228	2371	2603			KK p. 99 RO p. 100			
 TEMPO TO081 840 610 x 1710mm	M1	702	1287	1361	1475	1655						
	M2	804	1660	1660	1798	2029						
 TEMPO TO082 4410 610 x 1710mm	M1	1141	1705	1779	1892	2073			1 x ■	+55	+68	+51
	M2	1239	2072	2072	2207	2439			KK p. 99			
						!!! SUPPLEMENT !!! magnetude Voor PVC WIT SCHRUNWERK: basisprijs kolom RAL POEDER. Pour CHASSIS PVC BLANC : colonne RAL POUDRE comme prix de base.						

SUPPLEMENT per paneel | par panneau

<p>M1 1 ZIJDE MOTIEF MOTIF 1 FACE</p> <p>M2 2 ZIJDEN MOTIEF MOTIF 2 FACES</p> <p>▼ buitenaanzicht vue extérieure</p>		<p>PVC wit blanc</p> <ul style="list-style-type: none"> • beige crème • 120 • 140 • 150 	<p>EXT folie filmé</p> <ul style="list-style-type: none"> • INT wit blanc • beige crème 	<p>EXT folie filmé</p> <ul style="list-style-type: none"> • INT folie filmé 	<p>RAL poeder poudre</p> <p>ⓘ p. 172-174</p>	<p>RAL pistool pistolet</p>	SUPPL. magnetude		opties glas / options vitrage ⓘ p. 12-13			
							1 ZIJDE FACE	2 ZIJDEN FACES	<p>glas vormen</p> <ul style="list-style-type: none"> • <p>forme du vitrage</p>	<p>gelaagd 33.2</p> <ul style="list-style-type: none"> • <p>feuilleté 33.2</p>	<p>sablé met klare boord</p> <ul style="list-style-type: none"> • <p>sablé avec bord clair</p>	<p>coating 1,1</p> <ul style="list-style-type: none"> • met kern ISOL+, MU20 of HDP25 • avec âme ISOL+, MU20 ou HDP25
							ⓘ p. 7-11	ⓘ p. 7-11				
<p>AMBASSADE TO091 870</p> <p>590 x 1730mm</p>	M1	630										
	M2	738										
<p>AMBASSADE TO092 4710</p> <p>590 x 1730mm</p>	M1	1044						1x ■	+55	+68	+51	
	M2	1153						SG p. 100 KK p. 99				
<p>MATTEO TO101 750</p> <p>580 x 1720mm</p>	M1		1304	1379	1495	1664						
	M2		1675	1675	1824	2064						
<p>MATTEO TO102 3510</p> <p>580 x 1720mm</p>	M1		1716	1792	1907	2079		1x ■	+55	+68	+51	
	M2		2086	2086	2231	2471		SG p. 100 KK p. 99				
	M1											
	M2											
	M1											
	M2											

**!!! SUPPLEMENT !!!
magnetude**





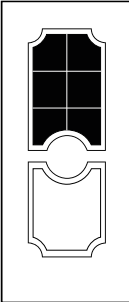
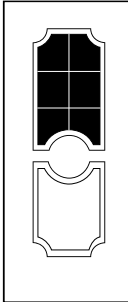
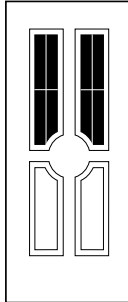
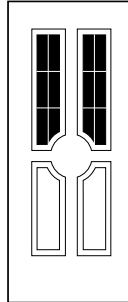
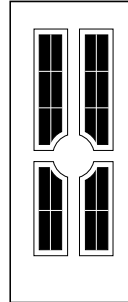
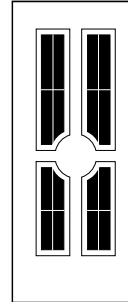
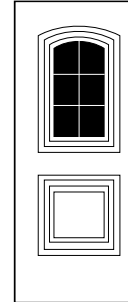
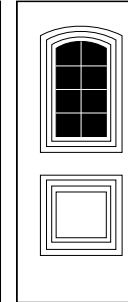
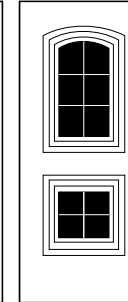
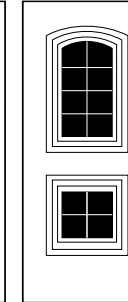
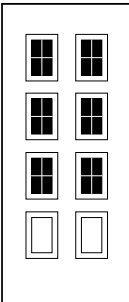
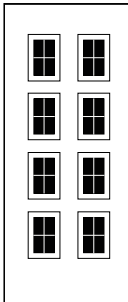
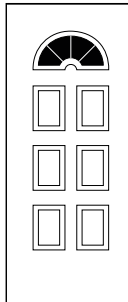
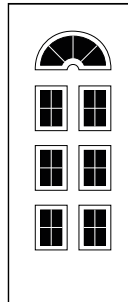
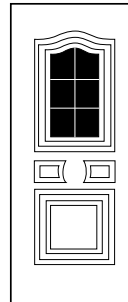
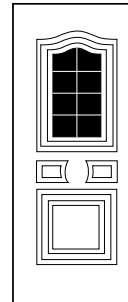
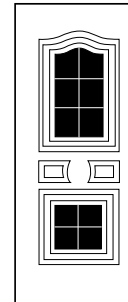
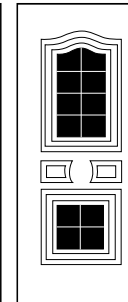
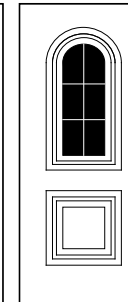
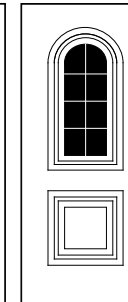
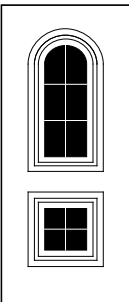
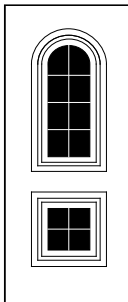
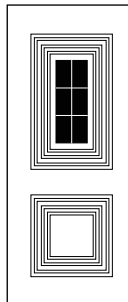
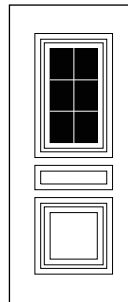
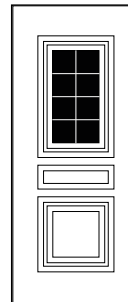
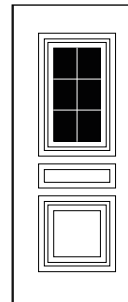
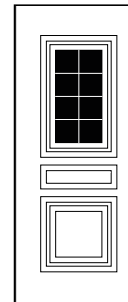



Voor PVC WIT SCHRUIJWERK:
basisprijs kolom RAL POEDER.
Pour CHASSIS PVC BLANC :
colonne RAL POUDRE
comme prix de base.

KRUISKOZIJJEN (KK) | PETITS BOIS INTEGRES (PBI)

ELEGANCE TO012  1xK02	ELEGANCE TO014  1xK02	MONZA TO022  2xK01	MONZA TO022  2xK02	MONZA TO023  2xK01+2xK02	MONZA TO023  4xK01	ROYAL TO032  1xK02	ROYAL TO032  1xK03	ROYAL TO033  1xK01+1xK02	ROYAL TO033  1xK01+1xK03
VIKTORIA TO042  6xK01	VIKTORIA TO043  8xK01	NIKITA TO052  1xK05	NIKITA TO053  6xK01+1xK05	CHATEAU TO062  1xK02	CHATEAU TO062  1xK03	CHATEAU TO063  1xK01+1xK02	CHATEAU TO063  1xK01+1xK03	PAVERA TO072  1xK02	PAVERA TO072  1xK03
PAVERA TO073  1xK01+1xK02	PAVERA TO073  1xK01+1xK03	TEMPO TO082  1xK02	AMBASSADE TO092  1xK02	AMBASSADE TO092  1xK03	MATTEO TO102  1xK02	MATTEO TO102  1xK03			

Voor opties, prijzen en beperkingen zie p. 16 | Pour options, prix et limitations voir p. 16

suppl. SIERGLAZEN | VITRAGES DÉCORATIFS

ELEGANCE TO012  L606 € 545	ELEGANCE TO012  D510A € 419	ELEGANCE TO012  D510B € 419	ELEGANCE TO012  Z1065 € 419	ELEGANCE TO012  Z1225 € 419	ELEGANCE TO014  D515A € 419	ELEGANCE TO014  D515B € 419	ELEGANCE TO014  Z1065 € 419
---	---	---	---	---	---	--	---

suppl. SIERGLAZEN | VITRAGES DÉCORATIFS

<p>MONZA TO022</p> <p>D530A € 678</p>	<p>MONZA TO022</p> <p>D530B € 678</p>	<p>ROYAL TO032</p> <p>V704 € 545</p>	<p>ROYAL TO032</p> <p>D540A € 419</p>	<p>ROYAL TO032</p> <p>D540B € 419</p>	<p>ROYAL TO032</p> <p>Z1095 € 419</p>	<p>ROYAL TO032</p> <p>Z1225 € 419</p>	<p>NIKITA TO052</p> <p>D630A € 419</p>
<p>NIKITA TO052</p> <p>D630B € 419</p>	<p>NIKITA TO053</p> <p>D630C € 1324</p>	<p>NIKITA TO053</p> <p>D630D € 1324</p>	<p>CHATEAU TO062</p> <p>V705 545</p>	<p>CHATEAU TO062</p> <p>D650A € 419</p>	<p>CHATEAU TO062</p> <p>D650B € 419</p>	<p>CHATEAU TO062</p> <p>Z1165 € 419</p>	<p>CHATEAU TO062</p> <p>Z1225 € 419</p>
<p>PAVERA TO072</p> <p>V707 € 545</p>	<p>PAVERA TO072</p> <p>D670A € 419</p>	<p>PAVERA TO072</p> <p>D670B € 419</p>	<p>PAVERA TO072</p> <p>Z1095 € 419</p>	<p>AMBASSADE TO092</p> <p>D870A € 419</p>	<p>AMBASSADE TO092</p> <p>D870B € 419</p>	<p>AMBASSADE TO092</p> <p>Z1165 € 419</p>	<p>MATTEO TO102</p> <p>D870A € 419</p>
<p>MATTEO TO102</p> <p>D870B € 419</p>	<p>MATTEO TO102</p> <p>Z1165 € 419</p>	<div style="display: flex; align-items: center;"> <div style="margin-left: 20px;"> <p>ROOSTER INBOUW GRILLE INTÉGRÉ DANS LE VITRAGE standaard zwart gelakt laqué noir standard</p> <p>Dikte paneel moet minstens zijn: L'épaisseur du panneau doit être de minimum : Niet gelaagd Non feuilleté ----> 36 mm 1Z gelaagd 1 face feuilleté ----> 40 mm 2Z gelaagd 2 faces feuilleté ----> 44 mm</p> <p>Enkel mogelijk in bovenste glas. Uniquement possible dans le vitrage supérieur.</p> <p><i>De inbouwroosters zijn ter illustratie. Grilles intégrées à titre indicatif.</i></p> </div> </div> <p>RO - cirkels/ruiten cercles/diamants 1 x = € 785 1 x = € 1082</p> <p>RO - eigen ontwerp propre design 1 x = € 1231 1 x = € 1548</p>					



Informatie | Information

Kernen • Ames	MU 20	ISOL + 22	HDP 25	THERMI- MAX 33	ISOMIX 37	AMAC 38 (b)	ISOMIX 40	ISOMIX 43
Totale dikte • Epaisseur totale PVC	23	25	28	36	40	41	43	46
Indien beglaasd meerprijs triple glas Si vitré, toujours suppl. triple vitrage	-	-	-	-	X	-	X	X
Indien beglaasd coating 1.1 standaard Si vitré, coating d'office 1,1	-	-	-	X	X	-	X	X
U-waarde • Valeur U W/m2 K	3,21	1,5	1,71	1,1	0,53	2,38	0,51	0,49
900 x 2100 - stand.	105	0	71	std.	125	314	135	146

(b) enkel onbeglaasd | uniquement non-vitré



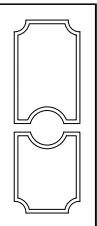
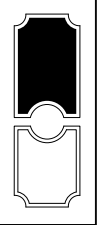
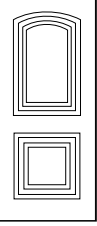
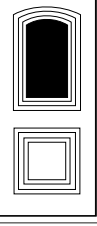
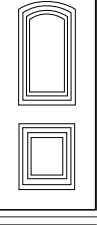
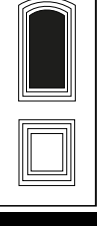



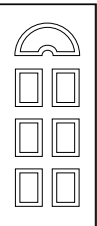
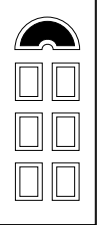
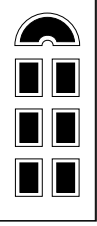
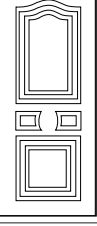
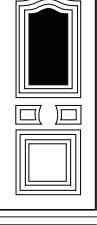
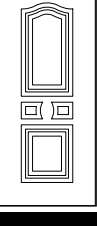





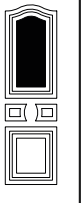

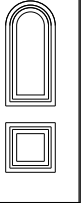

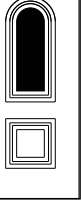
SUPPLEMENT per paneel | par panneau

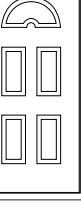
<p>M1 1 ZIJDE MOTIEF MOTIF 1 FACE</p> <p>M2 2 ZIJDEN MOTIEF MOTIF 2 FACES</p> <p>▼ buitenaanzicht vue extérieure</p>	<p>PVC wit blanc • beige crème • 120/140 150 0015 0018</p>	<p>EXT folie filmé • INT wit blanc • beige crème</p>	<p>EXT folie filmé • INT folie filmé</p>	<p>RAL poeder poudre • p. 172-174</p>	<p>RAL pistool pistolet •</p>	SUPPL. magnetude		opties glas / options vitrage ⓘ p. 12-13				
						1 ZIJDE FACE • p. 7-11	2 ZIJDEN FACES • p. 7-11	glas vormen • forme du vitrage	gelaagd 33.2 • feuilleté 33.2	sablé met klare board • sablé avec bord clair	coating 1,1 • met kern ISOL+ MU20 of HDP25 • avec âme ISOL+ MU20 ou HDP25	
						≤ 990x2190 mm	≤ 990x2190 mm					
 <p>PETRA MY011 50100</p> <p>590 x 1640mm</p>	M1											
	M2	451										
 <p>PETRA MY012 50110</p> <p>590 x 1640mm</p>	M1							1 x ♣	+65	+118	+51	
	M2	717						SG p. 113 KK p. 111				
 <p>TINA MY021 50400</p> <p>620 x 1630mm</p>	M1											
	M2	451										
 <p>TINA MY022 50410</p> <p>620 x 1630mm</p>	M1							1 x ■	+55	+118	+51	
	M2	717						SG p. 113 KK p. 111				
 <p>TINA MY023 55400</p> <p>530 x 1630mm</p>	M1											
	M2	451										
 <p>TINA MY024 55410</p> <p>530 x 1630mm</p>	M1							1 x ■	+55	+118	+51	
	M2	717						SG p. 113 KK p. 111				
						<p>!!! SUPPLEMENT !!! magnetude</p> <p>Voor PVC WIT SCHRUIJWERK: basisprijs kolom RAL POEDER. Pour CHASSIS PVC BLANC : colonne RAL POUDRE comme prix de base.</p>						

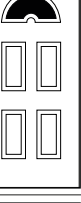

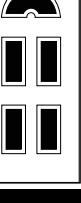
SUPPLEMENT per paneel | par panneau

<p>M1 1 ZIJDE MOTIEF MOTIF 1 FACE</p> <p>M2 2 ZIJDEN MOTIEF MOTIF 2 FACES</p> <p>▼ buitenaanzicht vue extérieure</p>	<p>PVC wit blanc • beige crème • 120/140 150 0015 0018</p>	<p>EXT folie filmé • INT wit blanc • beige crème</p>	<p>EXT folie filmé • INT folie filmé</p>	<p>RAL poeder poudre • p. 172-174</p>	<p>RAL pistool pistolet</p>	SUPPL. magnetude		opties glas / options vitrage ⓘ p. 12-13				
						1 ZIJDE FACE • p. 7-11	2 ZIJDEN FACES • p. 7-11	glas vormen • forme du vitrage	gelaagd 33.2 • feuilleté 33.2	sablé met klare boord • sablé avec bord clair	coating 1,1 • met kern ISOL+, MU20 of HDP25 • avec âme ISOL+, MU20 ou HDP25	
						≤ 990x2190 mm	≤ 990x2190 mm					
 <p>RIA MY031 60300</p> <p>600 x 1590mm</p>	M1											
	M2	451										
 <p>RIA MY032 60310</p> <p>600 x 1590mm</p>	M1							1 x ♣	+65	+118	+51	
	M2	717						SG p. 113 KK p. 111				
 <p>RIA MY033 60370</p> <p>600 x 1590mm</p>	M1							6 x ■ 1 x ♣	+395	+529	+357	
	M2	1080						SG p. 113 KK p. 111				
 <p>SOFIA MY041 60500</p> <p>590 x 1720mm</p>	M1											
	M2	451										
 <p>SOFIA MY042 60510</p> <p>590 x 1720mm</p>	M1							1 x ♣	+55	+118	+51	
	M2	717						SG p. 113 KK p. 111				
 <p>SOFIA MY043 65500</p> <p>530 x 1720mm</p>	M1											
	M2	451										
						<p>!!! SUPPLEMENT !!! magnetude</p> <p>Voor PVC WIT SCHRUIJWERK: basisprijs kolom RAL POEDER. Pour CHASSIS PVC BLANC : colonne RAL POUDRE comme prix de base.</p>						





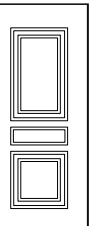
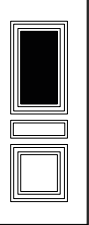
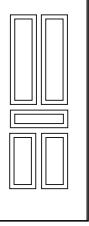

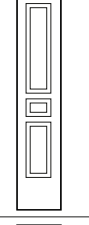
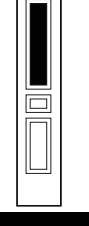
SUPPLEMENT per paneel | par panneau

M1 1 ZIJDE MOTIEF MOTIF 1 FACE M2 2 ZIJDEN MOTIEF MOTIF 2 FACES ▼ buitenaanzicht vue extérieure	PVC wit blanc • beige crème • 120/140 150 0015 0018	EXT folie filmé • INT wit blanc • beige crème	EXT folie filmé • INT folie filmé	RAL poeder poudre • p. 172-174	RAL pistool pistolet	SUPPL. magnetude		opties glas / options vitrage  p. 12-13			
						1 ZIJDE FACE •  p. 7-11	2 ZIJDEN FACES •  p. 7-11	glas vormen • forme du vitrage	gelaagd 33.2 • feuilleté 33.2	sablé met klare boord • sablé avec bord clair	coating 1,1 • met kern ISOL+ , MU20 of HDP25 • avec âme ISOL+ , MU20 ou HDP25
 SOFIA MY044 65510  530 x 1720mm	M1							1 x 	+55	+118	+51
	M2	717						SG p. 113 KK p. 111			
 MAXIMA MY051 60700  530 x 1690mm	M1										
	M2	451									
 MAXIMA MY052 60710  530 x 1690mm	M1							1 x 	+55	+108	+51
	M2	717						SG p. 113 KK p. 111			
 EVA MY061 60800  600 x 1490mm	M1										
	M2	451									
 EVA MY062 60810  600 x 1490mm	M1							1 x 	+65	+118	+51
	M2	717						SG p. 113-114 KK p. 111			
 EVA MY063 60850  600 x 1490mm	M1							4 x  1 x 	+285	+392	+255
	M2	1009						SG p. 114 KK p. 111			
						!!! SUPPLEMENT !!! magnetude Voor PVC WIT SCHRUIJWERK: basisprijs kolom RAL POEDER. Pour CHASSIS PVC BLANC : colonne RAL POUDRE comme prix de base.					

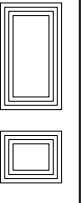

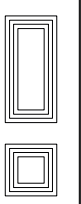
SUPPLEMENT per paneel | par panneau

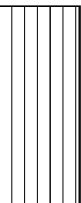
<p>M1 1 ZIJDE MOTIEF MOTIF 1 FACE</p> <p>M2 2 ZIJDEN MOTIEF MOTIF 2 FACES</p> <p>▼ buitenaanzicht vue extérieure</p>	<p>PVC wit blanc • beige crème • 120/140 150 0015 0018</p>	<p>EXT folie filmé • INT wit blanc • beige crème</p>	<p>EXT folie filmé • INT folie filmé</p>	<p>RAL poeder poudre • p. 172-174</p>	<p>RAL pistool pistolet •</p>	SUPPL. magnetude		opties glas / options vitrage ⓘ p. 12-13				
						1 ZIJDE FACE • p. 7-11	2 ZIJDEN FACES • p. 7-11	glas vormen • forme du vitrage	gelaagd 33.2 • feuilleté 33.2	sablé met klare boord • sablé avec bord clair	coating 1,1 • met kern ISOL+ , MU20 of HDP25 • avec âme ISOL+ , MU20 ou HDP25	
						≤ 990x2190 mm	≤ 990x2190 mm					
 <p>MATHILDA MY071 80700</p> <p>590 x 1730mm</p>	M1											
	M2	451										
 <p>MATHILDA MY072 80710</p> <p>590 x 1730mm</p>	M1							1 x ■	+55	+68	+51	
	M2	717						SG p. 114 KK p. 111				
 <p>ELENA MY081 80800</p> <p>585 x 1730mm</p>	M1											
	M2	451										
 <p>ELENA MY082 80820</p> <p>585 x 1730mm</p>	M1							2 x ■	+110	+137	+102	
	M2	915						SG p. 114 KK p. 111				
 <p>MIRA MY091 80907</p> <p>290 x 1730mm</p>	M1											
	M2	301										
 <p>MIRA MY092 80917</p> <p>290 x 1730mm</p>	M1							1 x ■	+55	+68	+51	
	M2	516						SG p. 114 KK p. 111				
						<p>!!! SUPPLEMENT !!! magnetude</p> <p>Voor PVC WIT SCHRUIJWERK: basisprijs kolom RAL POEDER. Pour CHASSIS PVC BLANC : colonne RAL POUDRE comme prix de base.</p>						



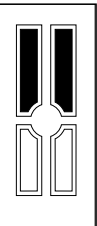

SUPPLEMENT per paneel | par panneau

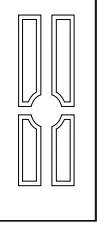
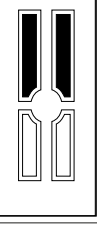
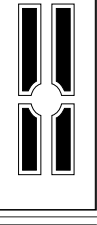
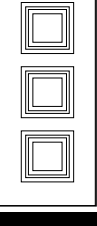
<p>M1 1 ZIJDE MOTIEF MOTIF 1 FACE</p> <p>M2 2 ZIJDEN MOTIEF MOTIF 2 FACES</p> <p>▼ buitenaanzicht vue extérieure</p>	<p>PVC wit blanc • beige crème • 120/140 150 0015 0018</p>	<p>EXT folie filmé • INT wit blanc • beige crème</p>	<p>EXT folie filmé • INT folie filmé</p>	<p>RAL poeder poudre • p. 172-174</p>	<p>RAL pistool pistolet •</p>	SUPPL. magnetude		opties glas / options vitrage ⓘ p. 12-13			
						1 ZIJDE FACE • p. 7-11	2 ZIJDEN FACES • p. 7-11	glas vormen • forme du vitrage	gelaagd 33.2 • feuilleté 33.2	sablé met klare board • sablé avec bord clair	coating 1,1 • met kern ISOL+ MU20 of HDP25 • avec à me ISOL+ MU20 ou HDP25
						≤ 990x2190 mm	≤ 990x2190 mm				
 <p>LUCA MY101 80100</p> <p>620 x 1720mm</p>	M1										
	M2	451									
 <p>LUCA MY102 80110</p> <p>620 x 1720mm</p>	M1							1 x ■	+55	+68	+51
	M2	717						SG p. 114 KK p. 111			
 <p>LUCA MY103 85100</p> <p>530 x 1720mm</p>	M1										
	M2	451									
 <p>LUCA MY104 85110</p> <p>530 x 1720mm</p>	M1							1 x ■	+55	+68	+51
	M2	717						SG p. 114 KK p. 111			
 <p>VERCA MY111 60200</p> <p>90 x 210mm</p>	M1										
	M2	480									
 <p>PAOLA MY121 50300</p> <p>620 x 1640mm</p>	M1										
	M2	451									
						<p>!!! SUPPLEMENT !!! magnetude</p> <p>Voor PVC WIT SCHRUIJWERK: basisprijs kolom RAL POEDER. Pour CHASSIS PVC BLANC : colonne RAL POUDRE comme prix de base.</p>					



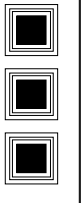

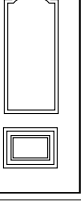
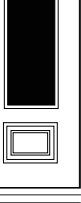





SUPPLEMENT per paneel | par panneau

<p>M1 1 ZIJDE MOTIEF MOTIF 1 FACE</p> <p>M2 2 ZIJDEN MOTIEF MOTIF 2 FACES</p> <p>▼ buitenaanzicht vue extérieure</p>	<p>PVC wit blanc • beige crème • 120/140 150 0015 0018</p>	<p>EXT folie filmé • INT wit blanc • beige crème</p>	<p>EXT folie filmé • INT folie filmé</p>	<p>RAL poeder poudre • p. 172-174</p>	<p>RAL pistool pistolet •</p>	SUPPL. magnetude		opties glas / options vitrage ⓘ p. 12-13			
						1 ZIJDE FACE • p. 7-11	2 ZIJDEN FACES • p. 7-11	glas vormen • forme du vitrage	gelaagd 33.2 • feuilleté 33.2	sablé met klare boord • sablé avec bord clair	coating 1,1 • met kern ISOL+ , MU20 of HDP25 • avec âme ISOL+ , MU20 ou HDP25
						≤ 990x2190 mm	≤ 990x2190 mm				
 <p>PAOLA MY122 50320</p> <p>620 x 1640mm</p>	M1							2 x ■	+110	+137	+102
	M2	915						SG p. 114 KK p. 111			
 <p>PAOLA MY123 50340</p> <p>620 x 1640mm</p>	M1							4 x ■	+220	+274	+204
	M2	1114									
 <p>PAOLA MY124 55300</p> <p>530 x 1640mm</p>	M1										
	M2	451									
 <p>PAOLA MY125 55320</p> <p>530 x 1640mm</p>	M1							2 x ■	+110	+137	+102
	M2	915						KK p. 111			
 <p>PAOLA MY126 55340</p> <p>530 x 1640mm</p>	M1							4 x ■	+220	+274	+204
	M2	1114						KK p. 111			
 <p>NEVADA MY131 60600</p> <p>530 x 1720mm</p>	M1										
	M2	451									
						<p>!!! SUPPLEMENT !!! magnetude</p> <p>Voor PVC WIT SCHRUIJWERK: basisprijs kolom RAL POEDER. Pour CHASSIS PVC BLANC : colonne RAL POUDRE comme prix de base.</p>					

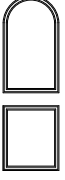
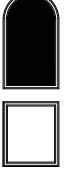

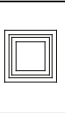
SUPPLEMENT per paneel | par panneau

<p>M1 1 ZIJDE MOTIEF MOTIF 1 FACE</p> <p>M2 2 ZIJDEN MOTIEF MOTIF 2 FACES</p> <p>▼ buitenaanzicht vue extérieure</p>	<p>PVC wit blanc • beige crème • 120/140 150 0015 0018</p>	<p>EXT folie filmé • INT wit blanc • beige crème</p>	<p>EXT folie filmé • INT folie filmé</p>	<p>RAL poeder poudre • p. 172-174</p>	<p>RAL pistool pistolet •</p>	SUPPL. magnetude		opties glas / options vitrage ⓘ p. 12-13			
						1 ZIJDE FACE • p. 7-11	2 ZIJDEN FACES • p. 7-11	glas vormen • forme du vitrage	gelaagd 33.2 • feuilleté 33.2	sablé met klare boord • sablé avec bord clair	coating 1,1 • met kern ISOL+, MU20 of HDP25 • avec âme ISOL+, MU20 ou HDP25
						≤ 990x2190 mm	≤ 990x2190 mm				
 <p>NEVADA MY132 60630</p> <p>530 x 1720mm</p>	M1							3 x ■	+165	+205	+153
	M2	1048						SG p. 114 KK p. 111			
 <p>PAVONA MY141 3 70400</p> <p>569 x 1630mm</p>	M1										
	M2	451									
 <p>PAVONA MY142 4 70410</p> <p>569 x 1630mm</p>	M1							1 x ♣	+65	+118	+51
	M2	717						KK p. 111-112			
 <p>PLEYADA MY151 80200</p> <p>570 x 1670mm</p>	M1										
	M2	451									
 <p>PLEYADA MY152 80210</p> <p>570 x 1670mm</p>	M1							1 x ♣	+65	+118	+51
	M2	717						KK p. 112			
 <p>ATLANTA MY161 70600</p> <p>550 x 1670mm</p>	M1										
	M2	451									
						<p>!!! SUPPLEMENT !!! magnetude</p> <p>Voor PVC WIT SCHRUIJWERK: basisprijs kolom RAL POEDER. Pour CHASSIS PVC BLANC : colonne RAL POUDRE comme prix de base.</p>					

SUPPLEMENT per paneel | par panneau

		PVC wit blanc • beige crème • 120/140 150 0015 0018	EXT folie filmé • INT wit blanc • beige crème	EXT folie filmé • INT folie filmé	RAL poeder poudre • p. 172-174	RAL pistool pistolet •	SUPPL. magnetude		opties glas / options vitrage  p. 12-13				
							1 ZIJDE FACE •  p. 7-11	2 ZIJDEN FACES •  p. 7-11	glas vormen • forme du vitrage	gelaagd 33.2 • feuilleté 33.2	sablé met klare boord • sablé avec bord clair	coating 1,1	
												met kern ISOL+ , MU20 of HDP25 • avec âme ISOL+ , MU20 ou HDP25	
▼ buitenaanzicht vue extérieure		900x2100x37 mm	900x2100x36 mm	900x2100x36 mm	900x2100x36 mm	900x2100x36 mm	≤ 990x2190 mm	≤ 990x2190 mm					
	ATLANTA MY162 70620	M1							2 x 	+130	+235	+102	
		M2	915						SG p. 114 KK p. 112				
	AZURA MY171 70800	M1											
		M2	451										
	AZURA MY172 70810	M1							1 x 	+65	+108	+51	
		M2	717						SG p. 114 KK p. 112				
	DIEGO MY181 607/OND	M1											
		M2	242										
	DEBORA MY191 25130	M1							3 x 	+165	+205	+153	
		M2	956						SG p. 114 KK p. 112				
	NARCA MY201 25430	M1							3 x 	+195	+324	+153	
		M2	1210						SG p. 114				
							!!! SUPPLEMENT !!! magnetude						
							Voor PVC WIT SCHRUIJWERK: basisprijs kolom RAL POEDER. Pour CHASSIS PVC BLANC : colonne RAL POUFRE comme prix de base.						

SUPPLEMENT per paneel | par panneau

<p>M1 1 ZIJDE MOTIEF MOTIF 1 FACE</p> <p>M2 2 ZIJDEN MOTIEF MOTIF 2 FACES</p> <p>▼ buitenaanzicht vue extérieure</p>	<p>PVC wit blanc • beige crème • 120/140 150 0015 0018</p>	<p>EXT folie filmé • INT wit blanc • beige crème</p>				<p>RAL poeder poudre • RAL pistool pistolet</p>		<p>SUPPL. magnetude</p>		<p>opties glas / options vitrage ⓘ p. 12-13</p>				
		<p>900x2100x37 mm</p>	<p>900x2100x36 mm</p>	<p>900x2100x36 mm</p>	<p>900x2100x36 mm</p>	<p>900x2100x36 mm</p>	<p>≤ 990x2190 mm</p>	<p>≤ 990x2190 mm</p>	<p>1 ZIJDE FACE • p. 7-11</p>	<p>2 ZIJDEN FACES • p. 7-11</p>	<p>glas vormen • forme du vitrage</p>	<p>gelaagd 33.2 • feuilleté 33.2</p>	<p>sablé met klare boord • sablé avec bord clair</p>	<p>coating 1,1</p>
														<p>met kern ISOL+, MU20 of HDP25 • avec âme ISOL+, MU20 ou HDP25</p>
 <p>CLARA MY211 25740</p> <p>439 x 1654mm</p>	M1									4 x ■	+220	+274	+204	
	M2	1048												KK p. 112
 <p>SENSA MY221 25250</p> <p>280 x 1732mm</p>	M1									5 x ■	+275	+342	+255	
	M2	1210												
	M1													
	M2													
	M1													
	M2													
	M1													
	M2													
										<p>!!! SUPPLEMENT !!! magnetude</p> <p>Voor PVC WIT SCHRUIJWERK: basisprijs kolom RAL POEDER. Pour CHASSIS PVC BLANC : colonne RAL POUDRE comme prix de base.</p>				

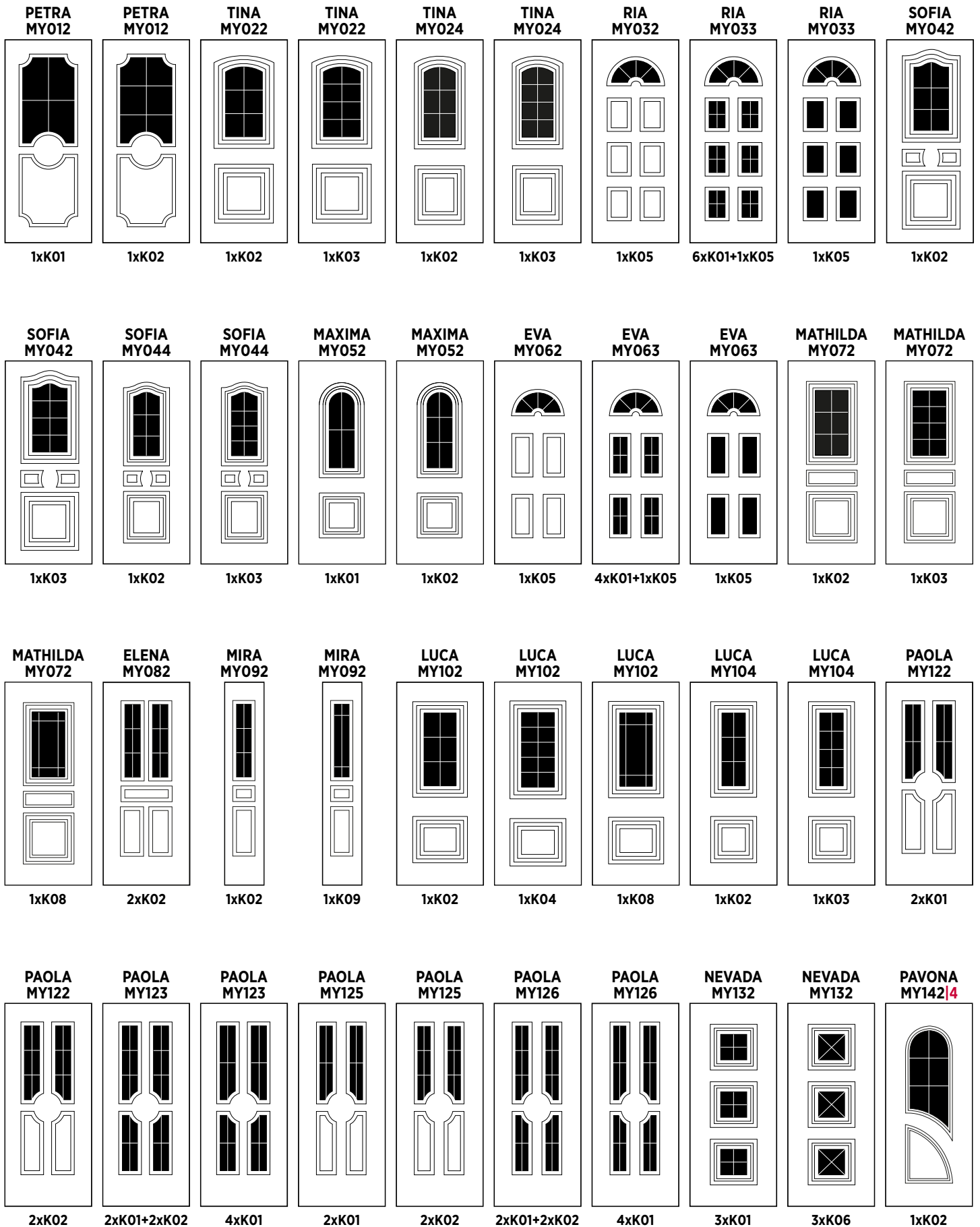

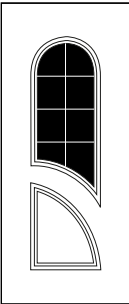
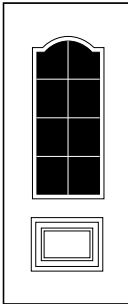
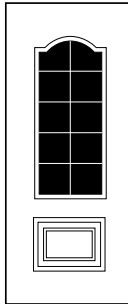
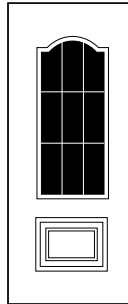
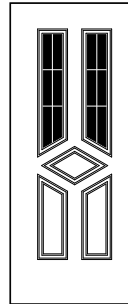
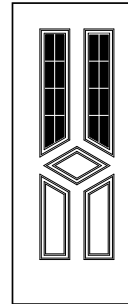
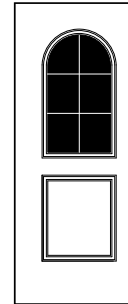
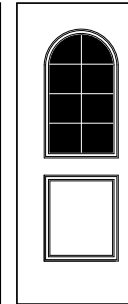
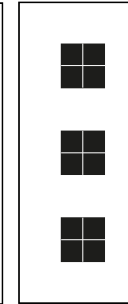
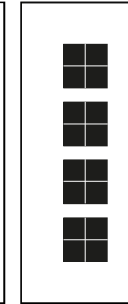
PAVONA MY142 4	PLEYADA MY152	PLEYADA MY152	PLEYADA MY152	ATLANTA MY162	ATLANTA MY162	AZURA MY172	AZURA MY172	DEBORA MY191	CLARA MY211
									
1xK03	1xK03	1xK04	1xK10	2xK02	2xK03	1xK02	1xK03	3xK01	4xK01

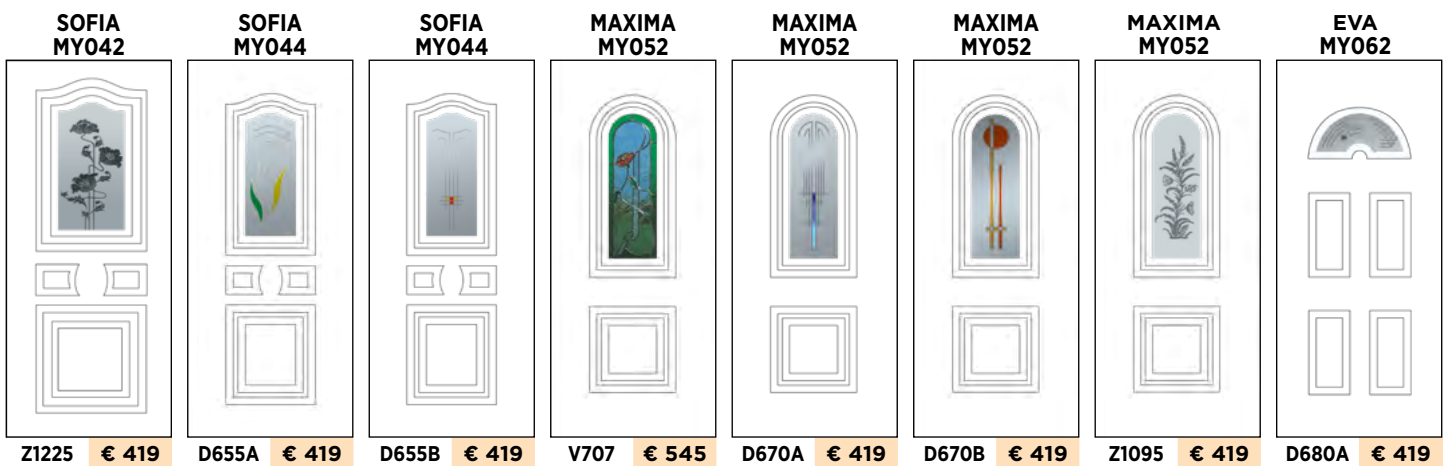
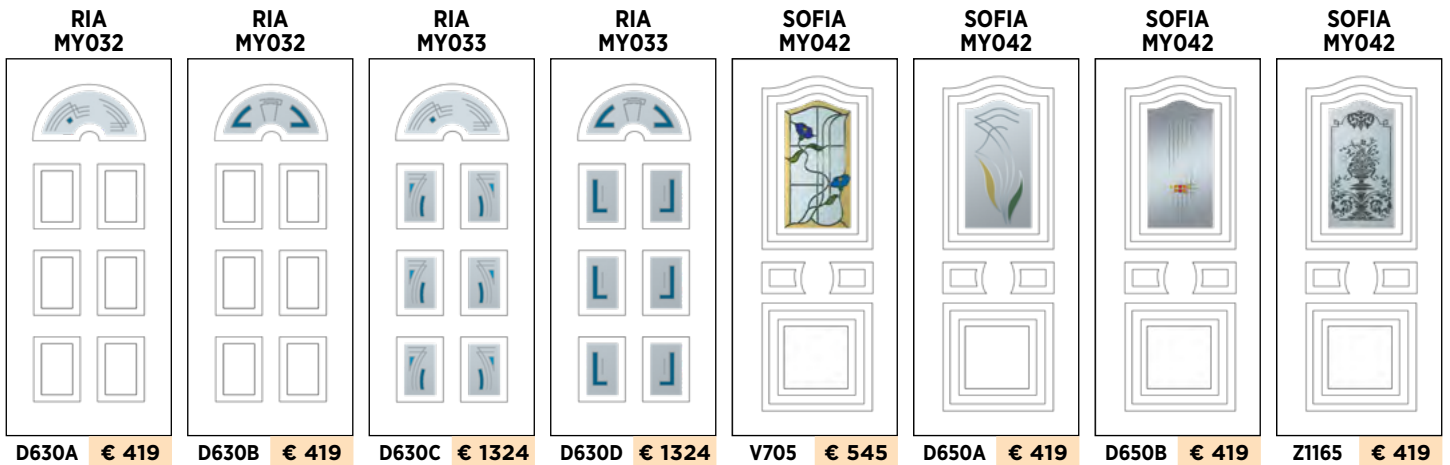
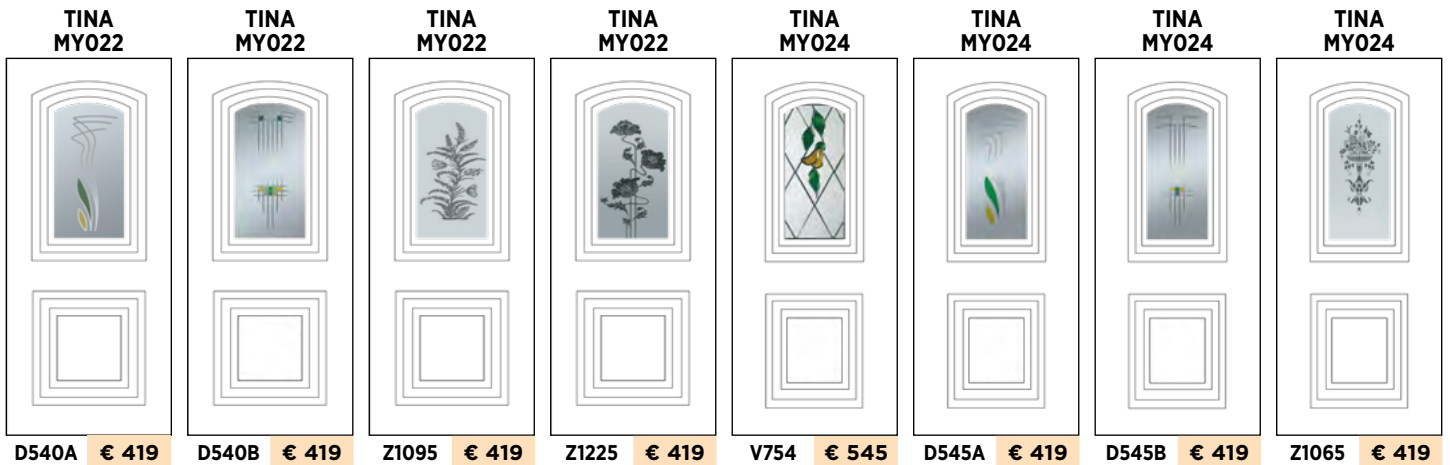
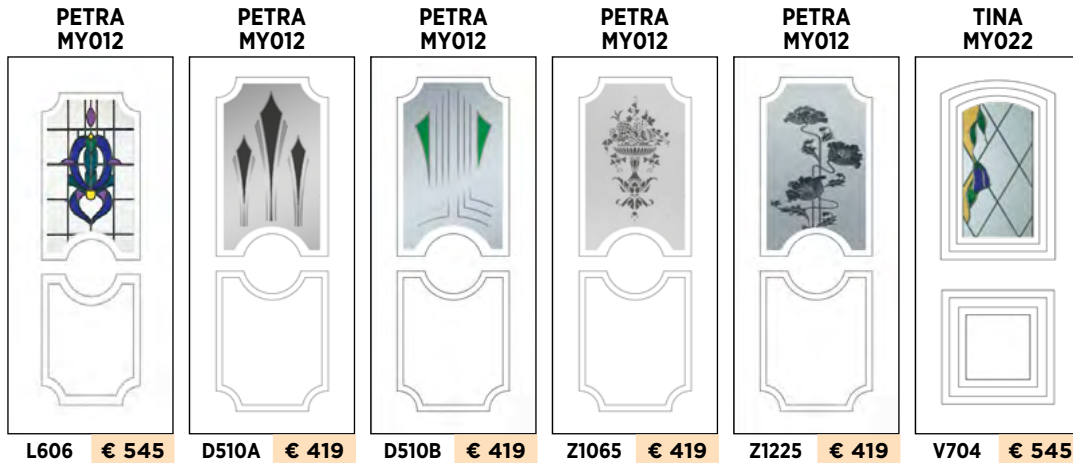

<p>EVA MY062</p> <p>D680B € 419</p>	<p>EVA MY063</p> <p>V708 € 545</p>	<p>EVA MY063</p> <p>D680C € 1066</p>	<p>EVA MY063</p> <p>D680D € 1066</p>	<p>MATHILDA MY072</p> <p>D870A € 419</p>	<p>MATHILDA MY072</p> <p>D870B € 419</p>	<p>MATHILDA MY072</p> <p>Z1165 € 419</p>	<p>ELENA MY082</p> <p>D880A € 678</p>
<p>ELENA MY082</p> <p>D880B € 678</p>	<p>MIRA MY092</p> <p>D880C € 419</p>	<p>MIRA MY092</p> <p>D880D € 419</p>	<p>MIRA MY092</p> <p>D880E € 419</p>	<p>LUCA MY102</p> <p>D900A € 419</p>	<p>LUCA MY102</p> <p>D900B € 419</p>	<p>LUCA MY104</p> <p>D905A € 419</p>	<p>LUCA MY104</p> <p>D905B € 419</p>
<p>PAOLA MY122</p> <p>D530A € 678</p>	<p>PAOLA MY122</p> <p>D530B € 678</p>	<p>NEVADA MY132</p> <p>D660A € 807</p>	<p>NEVADA MY132</p> <p>D660B € 807</p>	<p>ATLANTA MY162</p> <p>F1621 € 1066</p>	<p>AZURA MY172</p> <p>F1721 € 984</p>	<p>DEBORA MY191</p> <p>D178B € 936</p>	<p>NARCA MY201</p> <p>D184B € 936</p>

c classics

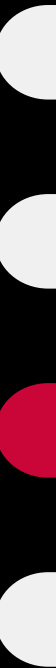

DIAMANT



EXPANSION

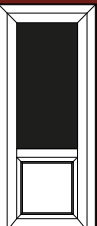
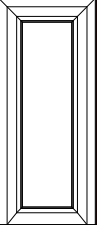
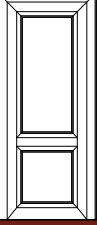
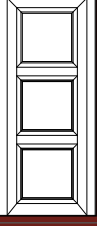
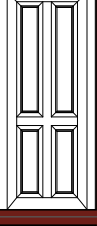
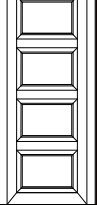

informatie | information

			PVC wit blanc • beige crème • 120 140 150	EXT folie filmé • INT wit blanc • beige crème	EXT folie filmé • INT folie filmé	RAL poeder poudre • p. 176-178	RAL pistool pistolet
▼ buitenaanzicht vue extérieure			900x2100x37 mm	900x2100x36 mm	900x2100x36 mm	900x2100x36 mm	900x2100x36 mm
	APATIET DI011 DIAMANT K1/2	M1	740	751	751	740	883
		M2	835	859	859	835	978
	PERIDOOT DI021 DIAMANT K1	M1	889	901	901	889	1032
		M2	978	1002	1002	978	1121
	FLUORIET DI031 DIAMANT K2	M1	966	990	990	966	1109
		M2	1140	1187	1187	1140	1282
	ROBIJN DI041 DIAMANT K3	M1	1062	1109	1109	1062	1205
		M2	1306	1402	1402	1306	1450
	SAFFIER DI051 DIAMANT K4	M1	1146	1205	1205	1146	1289
		M2	1385	1504	1504	1385	1528
	MALACHIET DI061 DIAMANT K4	M1	1146	1205	1205	1146	1289
		M2	1385	1504	1504	1385	1528

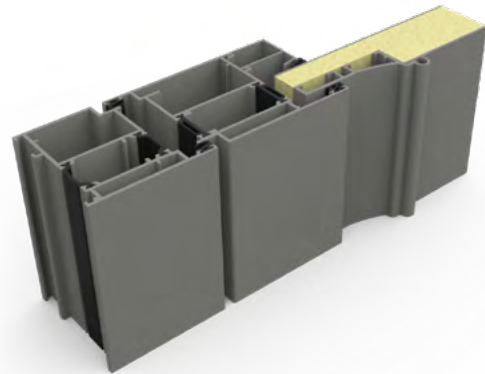

M1
(ALU)

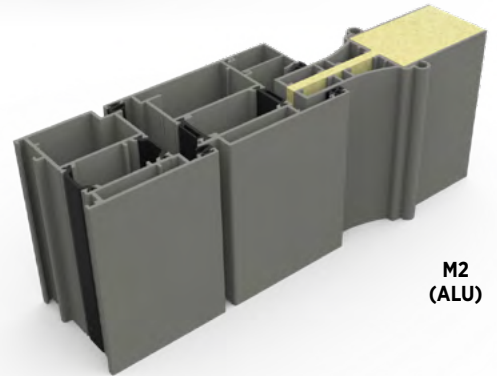

M2
(ALU)

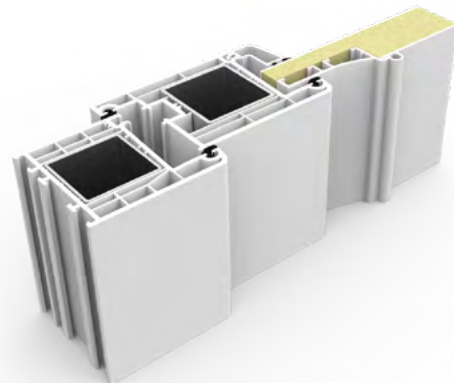

M1
(PVC)

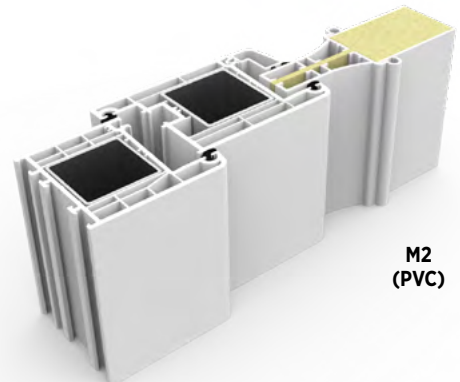

M2
(PVC)

Traverse en glas te voorzien door constructeur. | Traverse et vitrage à prévoir par le fabricant.

informatie | information

<p>M1 1 ZIJDE MOTIEF SIERLIJST MOTIF 1 FACE</p> <p>M2 2 ZIJDEN MOTIEF SIERLIJST MOTIF 2 FACES</p>	PVC wit blanc • beige crème	EXT folie filmé • INT wit blanc • beige crème	EXT folie filmé • INT folie filmé	RAL poeder poudre p. 176-178	RAL pistool pistolet
	900x2100x37 mm	900x2100x36 mm	900x2100x36 mm	900x2100x36 mm	900x2100x36 mm

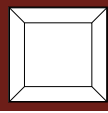
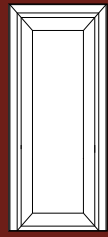
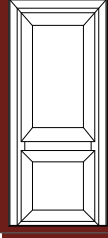
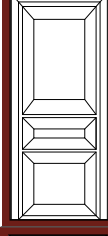
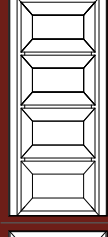
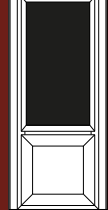
 <p>CALATRAVA EX011 EXPANSION K1/2</p> <p>230 x 230mm</p>	M1	971	1246	1246	971	1151
	M2					
 <p>STEINER EX021 EXPANSION K1</p> <p>230 x 900mm</p>	M1	1091	1366	1366	1091	1234
	M2					
 <p>LAMPENS EX031 EXPANSION K2</p> <p>230 x 460mm</p>	M1	1246	1523	1523	1246	1403
	M2					
 <p>PEI EX041 EXPANSION K3</p> <p>230 x 690mm</p>	M1	1391	1786	1786	1391	1547
	M2					
 <p>HADID EX051 EXPANSION K4</p> <p>230 x 920mm</p>	M1	1511	2350	2350	1511	1655
	M2					
 <p>BEEL EX061 EXPANSION K2 + V1</p> <p>230 x 460mm</p>	M1	1126	1403	1403	1126	1283
	M2					



M1
(ALU)



M1
(PVC)



WAGNER - detail / détail

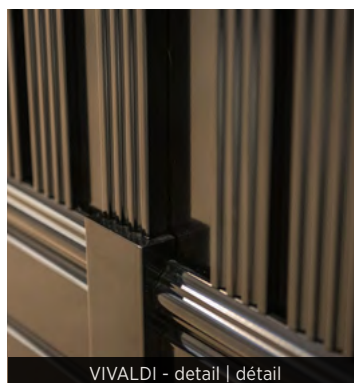

VIVALDI - detail | détail

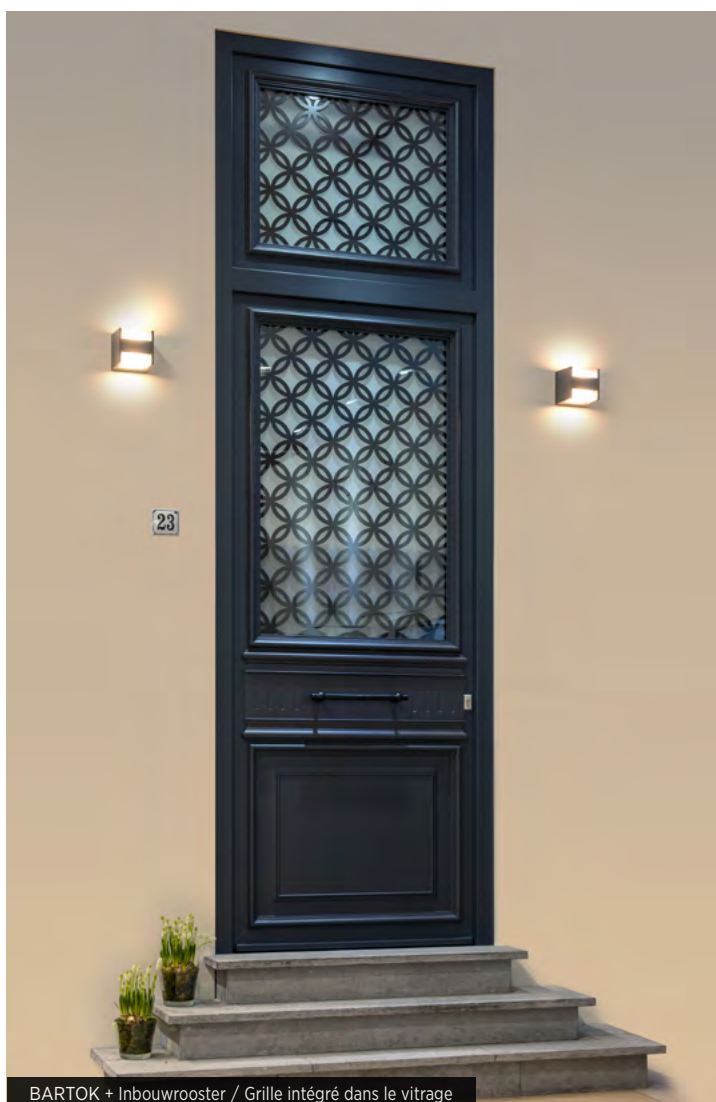

BARTOK + Inbouwrooster / Grille intégré dans le vitrage



BERLIOZ + Inbouwrooster / Grille intégré dans le vitrage

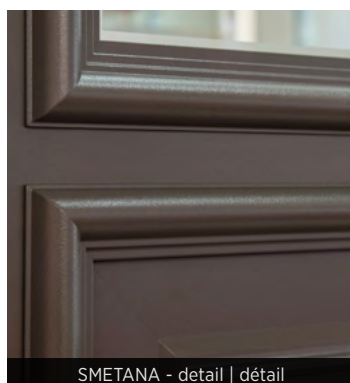













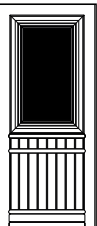
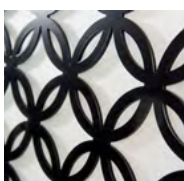

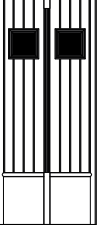
SMETANA - detail | détail

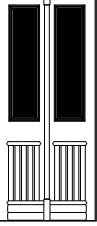

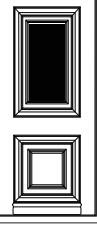
BACH - detail / détail

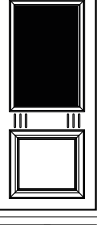
Supplementen | Suppléments

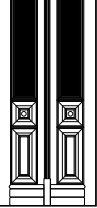
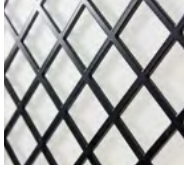
magnetude	1 ZIJDE FACE					2 ZIJDEN FACES				
	PVC	1Z folie filmé	2Z folie filmé	RAL poeder poudre	RAL pistool pistolet	PVC	1Z folie filmé	2Z folie filmé	RAL poeder poudre	RAL pistool pistolet
Formaat • Format										
990 x 2190	0	0	0	0	0	0	0	0	0	0
1240 x 2490	272	-	-	272	272	427	-	-	427	427
1140 x 2490	-	272	272	-	-	-	427	427	-	-
1140 x 2990	-	836	836	-	-	-	1226	1226	-	-
1490 x 2990	543	-	-	543	543	851	-	-	851	851



		VLEUGELOVERDEKKEND / CACHE-OUVRANT magnetude					SUPPLEMENT per paneel par panneau			
							opties glas / options vitrage  p. 12-13			
M1 1 ZIJDE MOTIEF SIERLIJST MOTIF 1 FACE M2 2 ZIJDEN MOTIEF SIERLIJST MOTIF 2 FACES		PVC wit blanc	EXT folie filmé	EXT folie filmé	RAL poeder poudre	RAL pistool pistolet	Rooster inbouw standaard zwart gelakt	glas vormen	gelaagd 33.2	plinten inbegrepen
▼ buitenaanzicht vue extérieure		• beige crème • 120 • 140 • 150	• INT wit blanc • beige crème	• INT folie filmé	•  p. 176-178	• Grille intégré dans le vitrage laqué noir standard De inbouwroosters zijn ter illustratie. Grilles intégrées à titre indicatif.	• forme du vitrage	• feuilleté 33.2	• plinthes inclus	
 BACH TR011 600 x 754mm	M1	3833	3833	3833	3833	4419	 + € 785	1x 	+55	3 x NOTAR A 2 x NOTAR B
	M2									
 WAGNER TR021 860 x 540mm	M1	3422	3422	3422	3422	4020		2x 	+110	2 x NOTAR A
	M2									
 VIVALDI TR031 860 x 694mm	M1	4877	4877	4877	4877	5463	 + € 1570	2x 	+55	4 x NOTAR A 4 x NOTAR B
	M2									
 SMETANA TR041 600 x 857mm	M1	4817	4817	4817	4817	5404	 + € 785	1x 	+55	1 x NOTAR A 1 x NOTAR B
	M2									
 BARTOK TR051 500 x 627mm	M1	2731	2731	2731	2731	3317	 + € 785	1x 	+55	
	M2									
 BERLIOZ TR061 860 x 1034mm	M1	3001	3001	3001	3001	3587	 + € 1570	2x 	+110	2 x NOTAR A 4 x NOTAR B
	M2									

CLASSIC op maat | sur mesure
 Steeds vleugeloverdekkend op maat voor u samengesteld met verschillende profielen, plinten en makelaars, Mail ons een foto van uw bestaande traditionele houten deur met afmetingen naar tradition@frager-fralu.com | Toujours proposé en modèle cache-ouvrant sur mesure combiné avec différents profilés, plinthes et profilés maclair. Envoyez nous une photo par mail de votre porte en bois traditionnelle existante avec vos dimensions à tradition@frager-fralu.com.

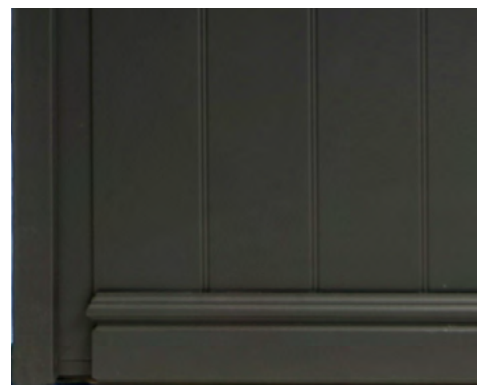
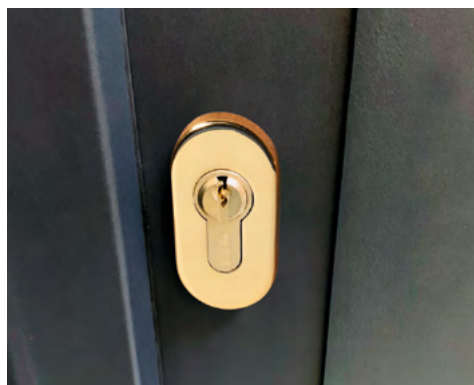
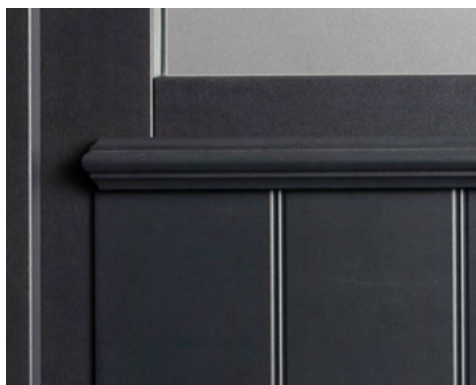
 ENKEL IN UNI-kleuren | UNIQUEMENT en couleurs UNIES - zie/voir www.frager.com.

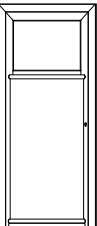

informatie | information

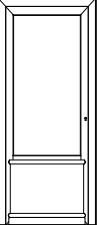
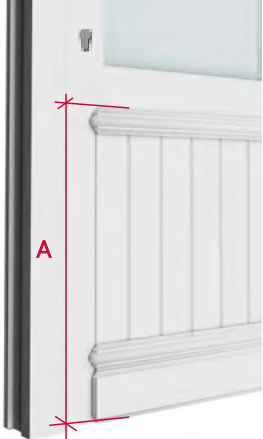
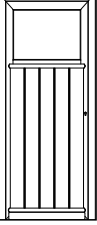
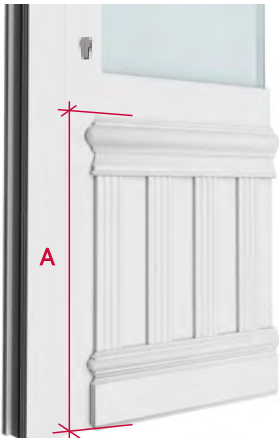
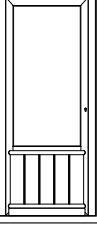
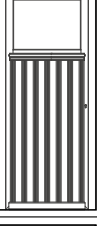
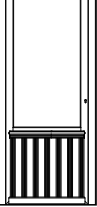
		VLEUGELOVERDEKKEND / CACHE-OUVRANT magnetude					plinten • plinthes	
		PVC wit blanc • beige crème • 120 140 150	EXT folie filmé • INT wit blanc • beige crème (a)	EXT folie filmé • INT folie filmé (a)	RAL poeder poudre p. 176-178	RAL pistool pistolet		
M1 1 ZIJDE MOTIEF SIERLIJST MOTIF 1 FACE M2 2 ZIJDEN MOTIEF SIERLIJST MOTIF 2 FACES ▼ buitenaanzicht vue extérieure								
 SATIE TR071 SATIE 3/4 (b)	M1	1885	1877	1950	1885	2226	2 x NOTAR A 1 x NOTAR B	 < NOTAR A (p. 163) < NOTAR A + NOTAR B (p. 163) A ≤ 1800: SATIE A ≤ 700: FAURE
	M2							
 FAURE TR081 SATIE 1/4 (c)	M1	1768	1759	1833	1837	2109	2 x NOTAR A 1 x NOTAR B	 < NOTAR A (p. 163) < Light Design type 1 (6 mm) (p. 18) < NOTAR A + NOTAR B (p. 163) A ≤ 1800: ELGAR A ≤ 700: RAVEL
	M2							
 ELGAR TR091 ELGAR 3/4 I (2) (b)	M1	2049	2041	2114	2049	2390	2 x NOTAR A 1 x NOTAR B	 < NOTAR A (p. 163) < NOTAR A + NOTAR B (p. 163) A ≤ 1800: GRIEG A ≤ 700: CAPLET
	M2							
 RAVEL TR101 ELGAR 1/4 I (2) (c)	M1	1931	1924	1997	1931	2273	2 x NOTAR A 1 x NOTAR B	
	M2							
 GRIEG TR111 GRIEG 3/4 (b)	M1	2471	2463	2537	2471	2812	1 x NOTAR A 1 x NOTAR B 1 PASTOR	< PASTOR (p. 163)
	M2							
 CAPLET TR121 GRIEG 1/4 (c)	M1	2119	2111	2185	2119	2460	1 x NOTAR A 1 x NOTAR B 1 PASTOR	< NOTAR A + NOTAR B (p. 163)
	M2							

Indicatif: afhankelijk van de afmetingen A, B, C, D. | Indicatif : dépend des dimensions A, B, C, D.

(a) ENKEL IN UNI-kleuren | Uniquement en couleurs UNIES - zie/voir www.frager.be

(b) max. 1800 mm, 1800 - 2200 mm: suppl. 10%

(c) max. 700 mm

DIAMANT

M1

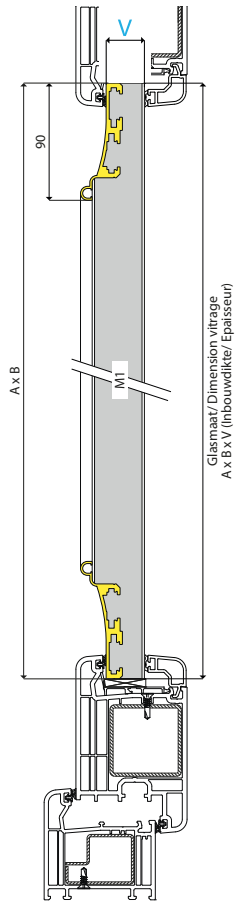

M2

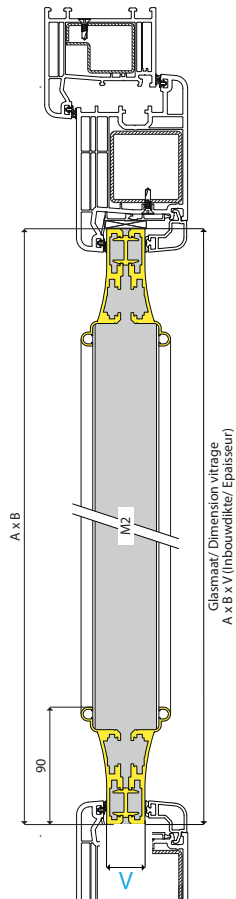

ROMANESQUE

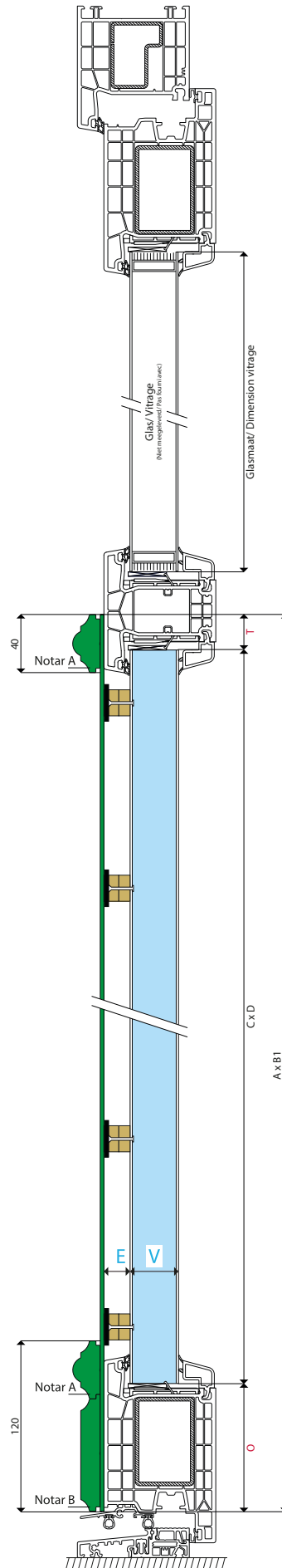

EXPANSION • LAMPENS - PEI - HADID

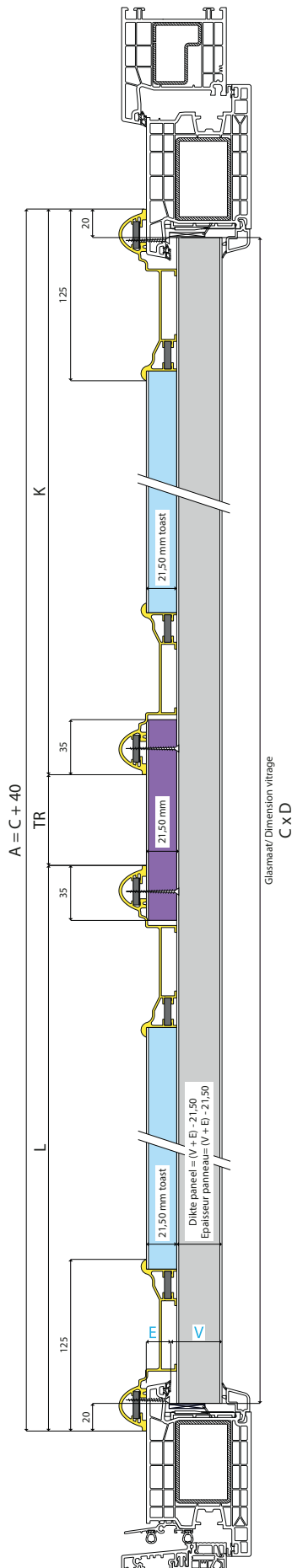

EXPANSION • BEEL

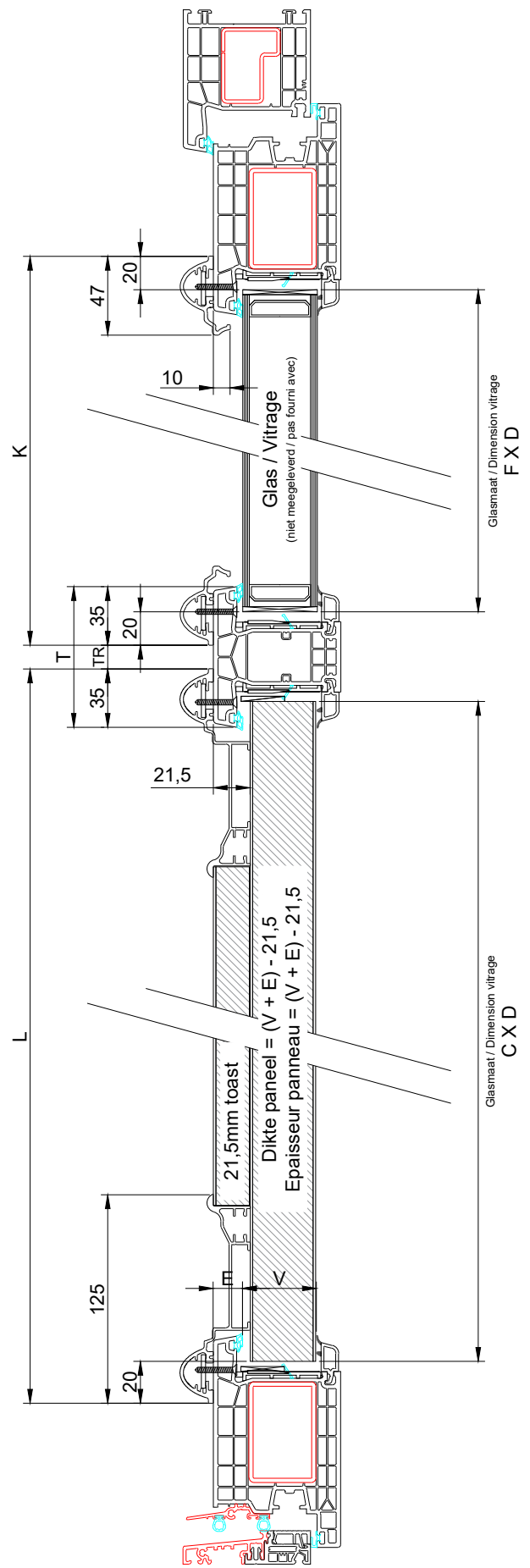

frager.

CREATORS OF DOORS

progress



Informatie | Information

Kernen • Ames	MU 20	ISOL + 22	HDP 25	THERMI-MAX 33	FLAMEBOARD 200 + (a)	ISOMIX 37	AMAC 38 (b)	ISOMIX 40	ISOMIX 43
Totale dikte • Epaisseur totale ALU/PVC	23/24	25/26	28/29	36/37	38/39	40/41	41/42	43/44	46/47
Indien beglaasd meerprijs triple glas • Si vitré, toujours rajouter plus-value triple vitrage	-	-	-	-	-	X	-	X	X
Indien beglaasd coating 1.1 standaard • Si vitré, le vitrage sera d'office avec 1,1	-	-	-	X	-	X	-	X	X
U-waarde • Valeur U W/m2 K	3,21	1,5	1,71	1,1	1,3	0,53	2,38	0,51	0,49
RW - dB Geluidswerend, enkel onbeglaasd • Acoustique, uniquement non-vitré		26		30		28	41	28	28

PVC wit of beige PVC blanc ou crème									
Formaat • Format	MU 20	ISOL + 22	HDP 25	THERMI-MAX 33	FLAMEBOARD 200 + (a)	ISOMIX 37	AMAC 38 (b)	ISOMIX 40	ISOMIX 43
900 x 2100	105	0	71	std.	-	125	314	135	146
1050 x 2200	-	92	-	90	-	179	-	189	206

FOLIE 1 zijdig of 2 zijdig FILME 1 face ou 2 faces									
Formaat • Format	MU 20	ISOL + 22	HDP 25	THERMI-MAX 33	FLAMEBOARD 200 + (a)	ISOMIX 37	AMAC 38 (b)	ISOMIX 40	ISOMIX 43
900 x 2100	105	0	71	std.	-	125	314	135	146
1050 x 2200	-	92	-	90	-	179	-	189	206
1150 x 2500	-	-	-	422	-	422	-	422	422
1150 x 3000	-	-	-	-	-	481	-	481	481











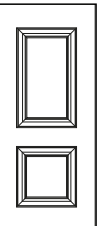
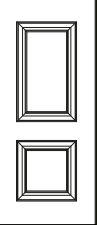
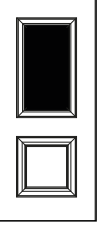

RAL poeder of pistool RAL poudre ou pistolet									
Formaat • Format	MU 20	ISOL + 22	HDP 25	THERMI-MAX 33	FLAMEBOARD 200 + (a)	ISOMIX 37	AMAC 38 (b)	ISOMIX 40	ISOMIX 43
900 x 2100	105	0	71	std.	166	125	314	135	146
1050 x 2200	-	92	-	90	-	179	-	189	206
1250 x 2500	-	-	-	362	-	362	-	362	362
1500 x 3000	-	-	-	-	-	481	-	481	481

magnetude	1 ZIJDE FACE					2 ZIJDEN FACES				
	PVC	1Z folie filmé	2Z folie filmé	RAL poeder poudre	RAL pistool pistolet	PVC	1Z folie filmé	2Z folie filmé	RAL poeder poudre	RAL pistool pistolet
Formaat • Format										
990 x 2190	0	0	0	0	0	0	0	0	0	0
1240 x 2490	272	-	-	272	272	427	-	-	427	427
1140 x 2490	-	272	272	-	-	-	427	427	-	-
1140 x 2990	-	836	836	-	-	-	1226	1226	-	-
1490 x 2990	543	-	-	543	543	851	-	-	851	851

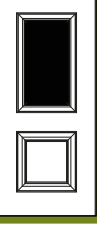
Formaten groter dan 1050x2200 mm zijn enkel leverbaar in België en Luxemburg. | Formats plus grands que 1050x2200 mm ne sont livrables qu'en Belgique et Luxembourg.

(a) enkel in combinatie met RAL poeder en onbeglaasd | uniquement possible en RAL poudre et non-vitré

(b) enkel onbeglaasd | uniquement non-vitré













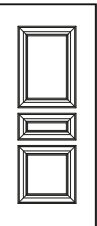

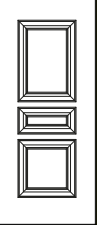

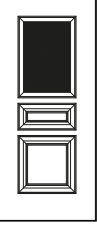
						SUPPLEMENT per paneel par panneau			opties glas / options vitrage  p. 12-13			
M1 1 ZIJDE MOTIEF MOTIF 1 FACE M2 2 ZIJDEN MOTIEF MOTIF 2 FACES ▼ buitenaanzicht vue extérieure	PVC wit blanc • beige crème • 120 140 150	EXT folie filmé • INT wit blanc • beige crème	EXT folie filmé • INT folie filmé	RAL poeder poudre •  p. 172-174	RAL pistool pistolet	SUPPL. magnetude		glas vormen • forme du vitrage	gelaagd 33.2 • feuilleté 33.2	sablé met klare boord • sablé avec bord clair	coating 1,1	
						1 ZIJDE FACE  p. 7-11	2 ZIJDEN FACES  p. 7-11				met kern ISOL+ , MU20 of HDP25 • avec âme ISOL+ , MU20 ou HDP25	
		900x2100x37 mm	900x2100x36 mm	900x2100x36 mm	900x2100x36 mm	900x2100x36 mm	≤ 990x2190 mm	≤ 990x2190 mm				
 PALLADIO PR011 PR 10A 590 x 1700mm	M1	1111	1929	1929	1481	1622	+463	+1257				
	M2	1531	2349	2349	1902	2042	+463	+1257				
 PALLADIO PR012 PR 10B 150 x 300mm	M1	1194	2012	2012	1564	1705	+463	+1257				
	M2	1693	2511	2511	2064	2204	+463	+1257				
 PALLADIO PR013 PR 11A 590 x 1700mm	M1								1 x 	+55	+68	+51
	M2	1853	2671	2671	2224	2364	+678	+1706	KK p. 133 RO p. 134			
 PALLADIO PR014 PR 11B 150 x 300mm	M1								1 x 	+55	+68	+51
	M2	1992	2810	2810	2363	2503	+678	+1706	KK p. 133 RO p. 134			
 PALLADIO PR015 PR 12A 590 x 1700mm	M1								2 x 	+110	+137	+102
	M2	2124	2942	2942	2495	2636	+820	+2155	KK p. 133 RO p. 134			
 PALLADIO PR016 PR 12B 150 x 300mm	M1								2 x 	+110	+137	+102
	M2	2271	3089	3089	2642	2783	+820	+2155	KK p. 133 RO p. 134			

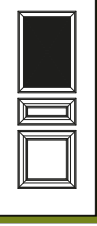
 Min. afmetingen bij inbouw. Bij **magnetude***: afhankelijk van de afmetingen A, B, C, D.
Dim. mini pour pose en feuillure. En **magnetude*** : dépend des dimensions A, B, C, D.

**!!! SUPPLEMENT !!!
magnetude**

Voor PVC WIT SCHRIJNWERK:
basisprijs kolom RAL POEDER.
Pour CHASSIS PVC BLANC :
colonne RAL-POUDRE
comme prix de base.

SUPPLEMENT per paneel | par panneau

<p>M1 1 ZIJDE MOTIEF MOTIF 1 FACE</p> <p>M2 2 ZIJDEN MOTIEF MOTIF 2 FACES</p> <p>▼ buitenaanzicht vue extérieure</p>	<p>PVC wit blanc • beige crème • 120 140 150</p>	<p>EXT folie filmé • INT wit blanc • beige crème</p>	<p>EXT folie filmé • INT folie filmé</p>	<p>RAL poeder poudre • p. 172-174</p>	<p>RAL pistool pistolet</p>	SUPPL. magnetude		opties glas / options vitrage  p. 12-13				
						1 ZIJDE FACE •  p. 7-11	2 ZIJDEN FACES •  p. 7-11	glas vormen • forme du vitrage	gelaagd 33.2 • feuilleté 33.2	sablé met klare boord • sablé avec bord clair	coating 1,1 • met kern ISOL+, MU20 of HDP25 • avec âme ISOL+, MU20 ou HDP25	
						≤ 990x2190 mm	≤ 990x2190 mm					
 <p>BERNINI PR021 PR 20A</p> <p> 590 x 1700mm</p>	M1	1278	2096	2096	1650	1790	+463	+1257				
	M2	1824	2642	2642	2195	2335	+463	+1257				
 <p>BERNINI PR022 PR 20B</p> <p> 150 x 300mm</p>	M1	1524	2342	2342	1896	2036	+463	+1257				
	M2	1963	2781	2781	2334	2474	+463	+1257				
 <p>BERNINI PR023 PR 21A</p> <p> 590 x 1700mm</p>	M1								1 x 	+55	+68	+51
	M2	2244	3062	3062	2616	2756	+668	+1706	KK p. 133 RO p. 134			
 <p>BERNINI PR024 PR 21B</p> <p> 150 x 300mm</p>	M1								1 x 	+55	+68	+51
	M2	2250	3068	3068	2622	2762	+668	+1706	KK p. 133 RO p. 134			
 <p>BERNINI PR025 PR 22A</p> <p> 590 x 1700mm</p>	M1								2 x 	+110	+137	+102
	M2	2374	3192	3192	2745	2885	+810	+2155	KK p. 133 RO p. 134			
 <p>BERNINI PR026 PR 22B</p> <p> 150 x 300mm</p>	M1								2 x 	+110	+137	+102
	M2	2546	3364	3364	2917	3057	+810	+2155	KK p. 133 RO p. 134			

 Min. afmetingen bij inbouw. Bij magnetude*: afhankelijk van de afmetingen A, B, C, D.
Dim. mini pour pose en feuillure. En magnetude* : dépend des dimensions A, B, C, D.

**!!! SUPPLEMENT !!!
magnetude**

Voor PVC WIT SCHRIJNWERK:
basisprijs kolom RAL POEDER.
Pour CHASSIS PVC BLANC :
colonne RAL POUDRE
comme prix de base.

SUPPLEMENT per paneel | par panneau





<p>M1 1 ZIJDE MOTIEF MOTIF 1 FACE</p> <p>M2 2 ZIJDEN MOTIEF MOTIF 2 FACES</p> <p>▼ buitenaanzicht vue extérieure</p>						SUPPL. magnetude		opties glas / options vitrage p. 12-13					
												p. 7-11	p. 7-11
	900x2100x37 mm	900x2100x36 mm	900x2100x36 mm	900x2100x36 mm	900x2100x36 mm	≤ 990x2190 mm	≤ 990x2190 mm						
	M1	1278	2096	2096	1650	1790	+463	+1257					
	M2	1824	2642	2642	2195	2335	+463	+1257					
	M1	1524	2342	2342	1896	2036	+463	+1257					
	M2	1963	2781	2781	2334	2474	+463	+1257					
	M1								1 x	+55	+68	+51	
	M2	2212	3030	3030	2584	2724	+651	+1706	KK p. 133				
	M1								1 x	+55	+68	+51	
	M2	2359	3177	3177	2731	2871	+651	+1706	KK p. 133				
	M1								2 x	+110	+137	+102	
	M2	2361	3179	3179	2732	2872	+790	+2155	KK p. 133				
	M1								2 x	+110	+137	+102	
	M2	2510	3328	3328	2881	3021	+790	+2155	KK p. 133				

Min. afmetingen bij inbouw. Bij magnetude*: afhankelijk van de afmetingen A, B, C, D.
 Dim. mini pour pose en feuilure. En magnetude*: dépend des dimensions A, B, C, D.

!!! SUPPLEMENT !!! magnetude

Voor PVC WIT SCHRIJNWERK: basisprijs kolom RAL POEDER.
 Pour CHASSIS PVC BLANC: colonne RAL-POUDRE comme prix de base.

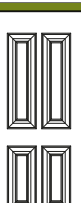
SUPPLEMENT per paneel | par panneau

<p>M1 1 ZIJDE MOTIEF MOTIF 1 FACE</p> <p>M2 2 ZIJDEN MOTIEF MOTIF 2 FACES</p> <p>▼ buitenaanzicht vue extérieure</p>	<p>PVC wit blanc • beige crème • 120 140 150</p>	<p>EXT folie filmé • INT wit blanc • beige crème</p>	<p>EXT folie filmé • INT folie filmé</p>	<p>RAL poeder poudre • p. 172-174</p>	<p>RAL pistool pistolet</p>	SUPPL. magnetude		opties glas / options vitrage ⓘ p. 12-13			
						1 ZIJDE FACE • p. 7-11	2 ZIJDEN FACES • p. 7-11	glas vormen • forme du vitrage	gelaagd 33.2 • feuilleté 33.2	sablé met klare board • sablé avec bord clair	coating 1,1 • met kern ISOL+, MU20 of HDP25 • avec âme ISOL+, MU20 ou HDP25
						≤ 990x2190 mm	≤ 990x2190 mm				
 <p>BRAMANTE PR037 PR 33A</p> <p>590 x 1700mm</p>	M1							3 x ■	+165	+205	+153
	M2	2512	3330	3330	2884	3023	+924	+2581	KK p. 133		
 <p>BRAMANTE PR038 PR 33B</p> <p>150 x 300mm</p>	M1							3 x ■	+165	+205	+153
	M2	2661	3479	3479	3033	3172	+924	+2581	KK p. 133		
 <p>BRUNELLESCHI PR041 PR 40A</p> <p>640 x 1700mm</p>	M1	1352	2170	2170	1724	1896	+463	+1257			
	M2	2059	2903	2903	2429	2602	+463	+1257			
 <p>BRUNELLESCHI PR042 PR 40B</p> <p>150 x 300mm</p>	M1	1352	2170	2170	1724	1896	+463	+1257			
	M2	2059	2903	2903	2429	2602	+463	+1257			
 <p>BRUNELLESCHI PR043 PR 42A</p> <p>640 x 1700mm</p>	M1							2 x ■	+110	+137	+102
	M2	2371	3188	3188	2742	2914	+783	+3413	KK p. 133		
 <p>BRUNELLESCHI PR044 PR 42B</p> <p>150 x 300mm</p>	M1							2 x ■	+110	+137	+102
	M2	2371	3188	3188	2742	2914	+783	+3413	KK p. 133		







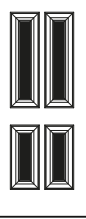
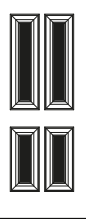
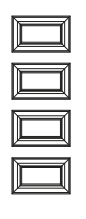
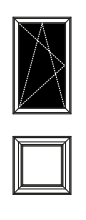





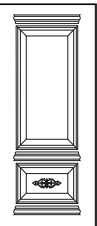

Min. afmetingen bij inbouw. Bij **magnetude***: afhankelijk van de afmetingen A, B, C, D.
Dim. mini pour pose en feuillure. En **magnetude***: dépend des dimensions A, B, C, D.

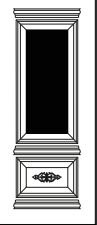
**!!! SUPPLEMENT !!!
magnetude**

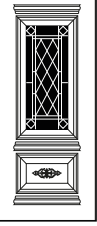
Voor PVC WIT SCHRIJNWERK:
basisprijs kolom RAL POEDER.
Pour CHASSIS PVC BLANC:
colonne RAL POUDRE
comme prix de base.

						SUPPLEMENT per paneel par panneau		opties glas / options vitrage ⑦ p. 12-13			
M1 1 ZIJDE MOTIEF MOTIF 1 FACE M2 2 ZIJDEN MOTIEF MOTIF 2 FACES ▼ buitenaanzicht vue extérieure	PVC wit blanc • beige crème • 120 140 150	EXT folie filmé • INT wit blanc • beige crème	EXT folie filmé • INT folie filmé	RAL poeder poudre • ⑦ p. 172-174	RAL pistool pistolet	SUPPL. magnetude		glas vormen • forme du vitrage	gelaagd 33.2 • feuilleté 33.2	sablé met klare bord • sablé avec bord clair	coating 1,1
	900x2100x37 mm	900x2100x36 mm	900x2100x36 mm	900x2100x36 mm	900x2100x36 mm	1 ZIJDE FACE ⑦ p. 7-11	2 ZIJDEN FACES ⑦ p. 7-11				met kern ISOL+ , MU20 of HDP25 • avec âme ISOL+ , MU20 ou HDP25
 BRUNELLESCHI PR045 PR 44A M1 M2 640 x 1700mm								4 x ■	+220	+274	+204
	2617	3435	3435	2988	3161	+1024	+3054	KK p. 133			
 BRUNELLESCHI PR046 PR 44B M1 M2 150 x 300mm								4 x ■	+220	+274	+204
	2617	3435	3435	2988	3161	+1024	+3054	KK p. 133			
 KAHN PR061 M1 M2 150 x 300mm											
	1278	2096	2096	1650	1790	+463	+1257				
						!!! SUPPLEMENT !!! magnetude Voor PVC WIT SCHRIJNWERK: basisprijs kolom RAL POEDER. Pour CHASSIS PVC BLANC : colonne RAL POUDRE comme prix de base.					
ENKEL magnetude • D'OFFICE magnetude standaard ft standard 990 x 2190 ▼ buitenaanzicht vue extérieure	VLEUGELOVERDEKKEND CACHE-OUVRANT magnetude							opties glas / options vitrage ⑦ p. 12-13			
	PVC wit blanc • beige crème • 120 140 150	EXT folie filmé • INT wit blanc • beige crème	EXT folie filmé • INT folie filmé	RAL poeder poudre • ⑦ p. 172-174	RAL pistool pistolet			glas vormen • forme du vitrage	gelaagd 33.2 • feuilleté 33.2	sablé met klare bord • sablé avec bord clair	
 NOUVEL PR071 M1 M2 570 x 1670mm								1 x ■	+55	+68	
	4319	4560	4677	4319	4911	Met opendraaiend raampje DRAAI-KIP • Avec fenêtre ouvrante OSCILLO-BATTANT					

⑦ Min. afmetingen bij inbouw. Bij **magnetude***: afhankelijk van de afmetingen A, B, C, D.
 Dim. mini pour pose en feuillure. En **magnetude*** : dépend des dimensions A, B, C, D.

						SUPPLEMENT per paneel par panneau		opties glas / options vitrage  p. 12-13				
M1 1 ZIJDE MOTIEF MOTIF 1 FACE M2 2 ZIJDEN MOTIEF MOTIF 2 FACES ▼ buitenaanzicht vue extérieure	PVC wit blanc • beige crème • 120 140 150	EXT folie filmé • INT wit blanc • beige crème	EXT folie filmé • INT folie filmé	RAL poeder poudre  p. 172-174	RAL pistool pistolet	SUPPL. magnetude		glas vormen • forme du vitrage	gelaagd 33.2 • feuilleté 33.2	sablé met klare board • sablé avec bord clair	coating 1,1	
						1 ZIJDE FACE  p. 7-11	2 ZIJDEN FACES  p. 7-11				met kern ISOL+, MU20 of HDP25 • avec âme ISOL+, MU20 ou HDP25	
		900x2100x37 mm	900x2100x36 mm	900x2100x36 mm	900x2100x36 mm	900x2100x36 mm	≤ 990x2190 mm	≤ 990x2190 mm				
 HORTA PR051 PR 70  620 x 1830mm	M1	1837	3089	3089	2604	2924	+537	+1257				
	M2	2288	3540	3540	3055	3380	+537	+1257				
 HORTA PR052 PR 71  620 x 1830mm	M1								1 x 	+55	+68	+51
	M2	2634	3886	3886	3401	3726	+759	+1706	KK p. 134			
 HORTA PR053 PR 71V  620 x 1830mm	M1								1 x 	+55		+51
	M2	3218	4450	4450	3992	4312	+759	+1840	SG p. 134			
 HORTA PR054 PR 71G  620 x 1830mm	M1								1 x 	+55	+68	+51
	M2	3010	4262	4262	3777	4097	+759	+1840	KK p. 134			
	M1											
	M2											
	M1											
	M2											

 Min. afmetingen bij inbouw. Bij magnetude*: afhankelijk van de afmetingen A, B, C, D.
Dim. mini pour pose en feuillure. En magnetude* : dépend des dimensions A, B, C, D.

**!!! SUPPLEMENT !!!
magnetude**

Voor PVC WIT SCHRIJNWERK:
basisprijs kolom RAL POEDER.
Pour CHASSIS PVC BLANC :
colonne RAL-POUDRE
comme prix de base.

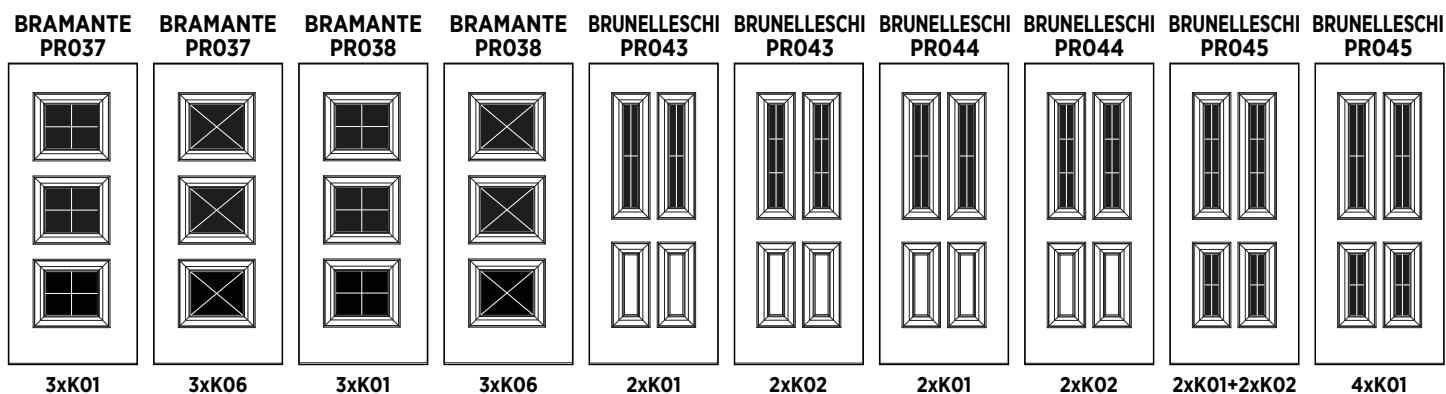
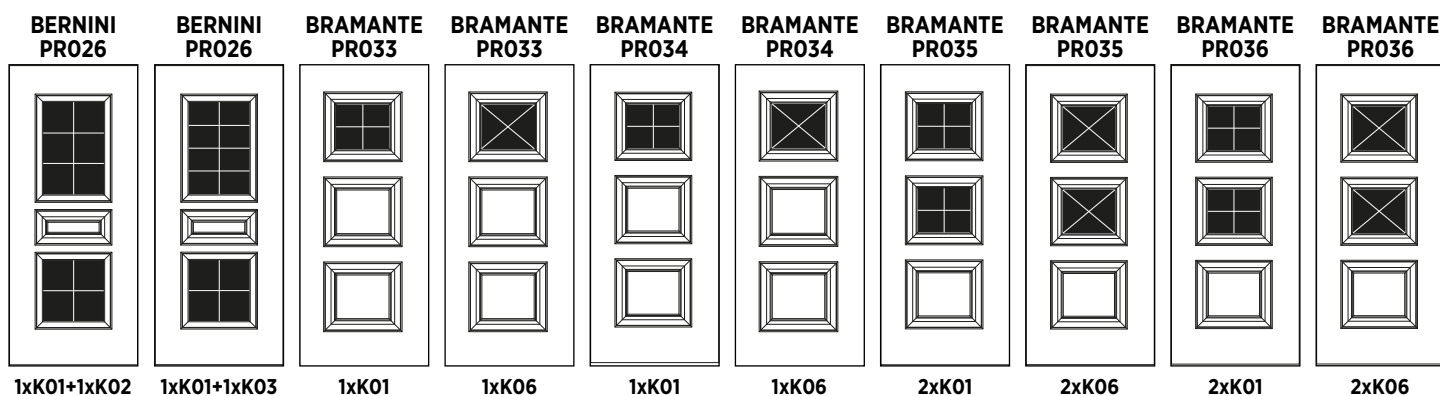
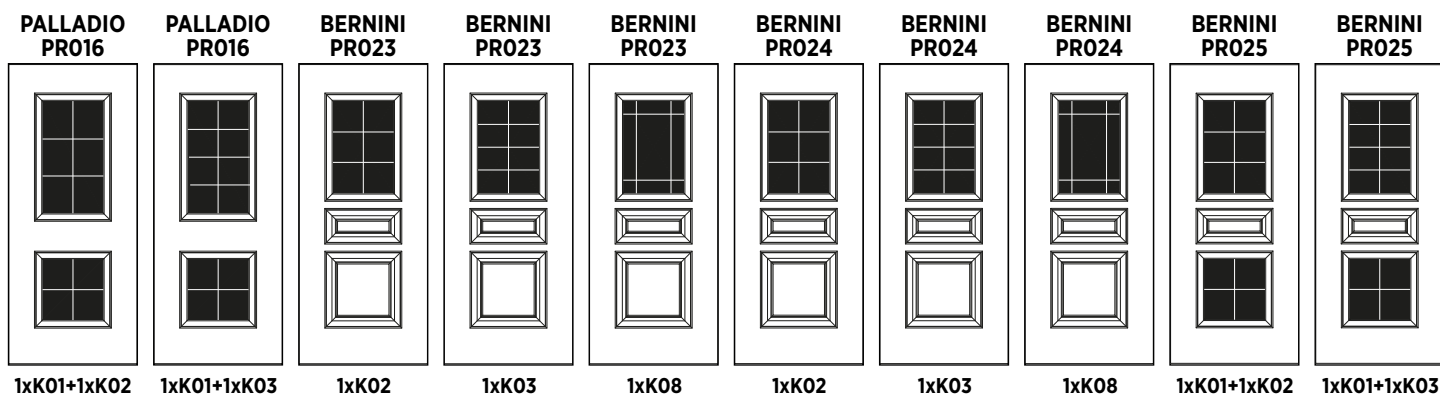
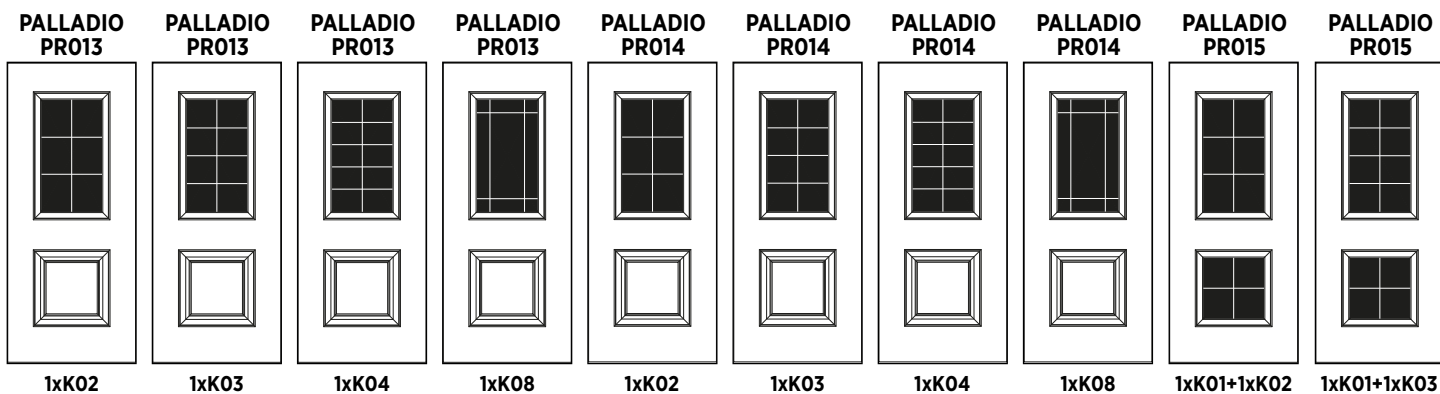

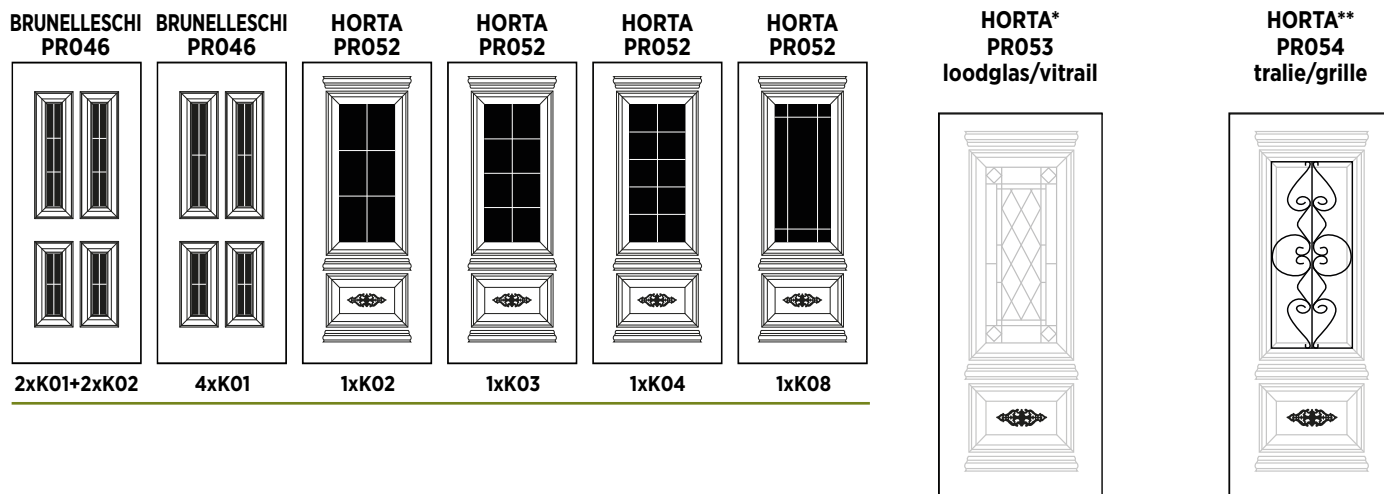

* Zwarte rozet apart meegeleverd
Rosace noire livré en fourniture seule

** Zwarte rooster + zwarte rozet apart meegeleverd
Grille & rosace noire livré en fourniture seule



RO - cirkels/ruiten | cercles/diamants

1 x ■ = € 785

1 x ◐ = € 1082

RO - eigen ontwerp | propre design

1 x ■ = € 1231

1 x ◐ = € 1548

ROOSTER INBOUW | GRILLE INTÉGRÉ DANS LE VITRAGE ***
standaard zwart gelakt | laqué noir standard

*** Rooster mogelijk indien de breedte van de kader groter is dan:
Grille possible si la largeur du cadre est plus grand que :
---> 480 mm

Dikte paneel moet minstens zijn:
L'épaisseur du panneau doit être de minimum :
Niet gelaagd | Non feuilleté ---> 36 mm
1Z gelaagd | 1 face feuilleté ---> 40 mm
2Z gelaagd | 2 faces feuilleté ---> 44 mm

Enkel mogelijk in bovenste glas.
Uniquement possible dans le vitrage supérieur.

De inbouwroosters zijn ter illustratie. | Grilles intégrées à titre indicatif.



Informatie | Information

Kernen • Ames	MU 20	ISOL + 22	HDP 25	THERMI-MAX 33	FLAMEBOARD 200 + (a)	ISOMIX 37	AMAC 38 (b)	ISOMIX 40	ISOMIX 43
Totale dikte • Epaisseur totale ALU/PVC	23/24	25/26	28/29	36/37	38/39	40/41	41/42	43/44	46/47
Indien beglaasd meerprijs triple glas • Si vitré, toujours rajouter plus-value triple vitrage	-	-	-	-	-	X	-	X	X
Indien beglaasd coating 1.1 standaard • Si vitré, le vitrage sera d'office avec 1,1	-	-	-	X	-	X	-	X	X
U-waarde • Valeur U W/m2 K	3,21	1,5	1,71	1,1	1,3	0,53	2,38	0,51	0,49
RW - dB Geluidswerend, enkel onbeglaasd • Acoustique, uniquement non-vitré		26		30		28	41	28	28

PVC wit of beige
PVC blanc ou crème

Formaat • Format	MU 20	ISOL + 22	HDP 25	THERMI-MAX 33	FLAMEBOARD 200 + (a)	ISOMIX 37	AMAC 38 (b)	ISOMIX 40	ISOMIX 43
900 x 2100	105	0	71	std	-	125	314	135	146
1050 x 2200	-	92	-	90	-	179	-	189	206

FOLIE 1 zijdig of 2 zijdig
FILME 1 face ou 2 faces

Formaat • Format	MU 20	ISOL + 22	HDP 25	THERMI-MAX 33	FLAMEBOARD 200 + (a)	ISOMIX 37	AMAC 38 (b)	ISOMIX 40	ISOMIX 43
900 x 2100	105	0	71	std	-	125	314	135	146
1050 x 2200	-	92	-	90	-	179	-	189	206
1150 x 2500	-	-	-	422	-	422	-	422	422
1150 x 3000	-	-	-	-	-	481	-	481	481

RAL poeder of pistool
RAL poudre ou pistolet

Formaat • Format	MU 20	ISOL + 22	HDP 25	THERMI-MAX 33	FLAMEBOARD 200 + (a)	ISOMIX 37	AMAC 38 (b)	ISOMIX 40	ISOMIX 43
900 x 2100	105	0	71	std	166	125	314	135	146
1050 x 2200	-	92	-	90	-	179	-	189	206
1250 x 2500	-	-	-	362	-	362	-	362	362
1500 x 3000	-	-	-	-	-	481	-	481	481

magnetude

1 ZIJDE | FACE



















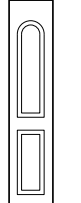

2 ZIJDEN | FACES

Formaat • Format	PVC	1Z folie filmé	2Z folie filmé	RAL poeder poudre	RAL pistool pistolet	PVC	1Z folie filmé	2Z folie filmé	RAL poeder poudre	RAL pistool pistolet
990 x 2190	0	0	0	0	0	0	0	0	0	0
1240 x 2490	272	-	-	272	272	427	-	-	427	427
1140 x 2490	-	272	272	-	-	-	427	427	-	-
1140 x 2990	-	836	836	-	-	-	1226	1226	-	-
1490 x 2990	543	-	-	543	543	851	-	-	851	851

Formaten groter dan 1050x2200 mm zijn enkel leverbaar in België en Luxemburg. | Formats plus grands que 1050x2200 mm ne sont livrables qu'en Belgique et Luxembourg.

(a) enkel in combinatie met RAL poeder en onbeglaasd | uniquement possible en RAL poudre et non-vitré











(b) enkel onbeglaasd | uniquement non-vitré

						SUPPLEMENT per paneel par panneau			opties glas / options vitrage  p. 12-13			
M1 1 ZIJDE MOTIEF MOTIF 1 FACE M2 2 ZIJDEN MOTIEF MOTIF 2 FACES ▼ buitenaanzicht vue extérieure	PVC wit blanc • beige crème • 120 140 150	EXT folie filmé • INT wit blanc • beige crème	EXT folie filmé • INT folie filmé	RAL poeder poudre • p. 172-174	RAL pistool pistolet	SUPPL. magnetude		glas vormen • forme du vitrage	gelaagd 33.2 • feuilleté 33.2	sablé met klare board • sablé avec bord clair	coating 1,1	
						1 ZIJDE FACE  p. 7-11	2 ZIJDEN FACES  p. 7-11				met kern ISOL+ , MU20 of HDP25 • avec âme ISOL+ , MU20 ou HDP25	
		900x2100x37 mm	900x2100x36 mm	900x2100x36 mm	900x2100x36 mm	900x2100x36 mm	≤ 990x2190 mm	≤ 990x2190 mm				
 WENEN AF011 101200  570 x 1670mm	M1	884	1702	1702	1281	1420	+463	+1276				
	M2	1081	1899	1899	1477	1617	+463	+1276				
 WENEN AF012 101210  570 x 1670mm	M1								1 x 	+65	+108	+51
	M2	1377	2195	2195	1772	1913	+737	+1859	SG p. 147 KK p. 145 RO p. 146			
 WENEN AF013 101220  570 x 1670mm	M1								1 x  1 x 	+120	+177	+102
	M2	1476	2294	2294	1872	2014	+883	+2307	SG p. 147 KK p. 145 RO p. 146			
 WENEN AF014 101209  270 x 1670mm	M1	691	1513	1513	1091	1231						
	M2	891	1712	1712	1289	1430						
 WENEN AF015 101219  270 x 1670mm	M1								1 x 	+65	+108	+51
	M2	1187	2007	2007	1584	1726			SG p. 147 KK p. 145			
 WENEN AF016 101229  270 x 1670mm	M1								1 x  1 x 	+120	+177	+102
	M2	1285	2105	2105	1683	1823			SG p. 147			

 Min. afmetingen bij inbouw. Bij **magnetude***: afhankelijk van de afmetingen A, B, C, D.
Dim. mini pour pose en feuillure. En **magnetude***: dépend des dimensions A, B, C, D.

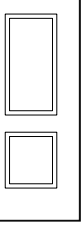
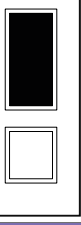
**!!! SUPPLEMENT !!!
magnetude**















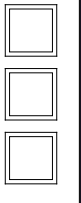



Voor PVC WIT SCHRIJNWERK:
basisprijs kolom RAL POEDER:
Pour CHASSIS PVC BLANC:
colonne RAL-POUDRE
comme prix de base.

						SUPPLEMENT per paneel par panneau			opties glas / options vitrage  p. 12-13			
M1 1 ZIJDE MOTIEF MOTIF 1 FACE M2 2 ZIJDEN MOTIEF MOTIF 2 FACES ▼ buitenaanzicht vue extérieure	PVC wit blanc • beige crème • 120 140 150	EXT folie filmé • INT wit blanc • beige crème	EXT folie filmé • INT folie filmé	RAL poeder poudre •  p. 172-174	RAL pistool pistolet	SUPPL. magnetude		glas vormen • forme du vitrage	gelaagd 33.2 • feuilleté 33.2	sablé met klare boord • sablé avec bord clair	coating 1,1	
						1 ZIJDE FACE •  p. 7-11	2 ZIJDEN FACES •  p. 7-11				met kern ISOL+ , MU20 of HDP25 • avec à me ISOL+ , MU20 ou HDP25	
		900x2100x37 mm	900x2100x36 mm	900x2100x36 mm	900x2100x36 mm	900x2100x36 mm	≤ 990x2190 mm	≤ 990x2190 mm				
 BURGOS AF021 103100 620 x 1670mm	M1	820	1638	1638	1217	1356	+463	+1196				
	M2	986	1804	1804	1382	1522	+463	+1196				
 BURGOS AF022 103110 620 x 1670mm	M1								1 x 	+55	+68	+51
	M2	1293	2111	2111	1688	1829	+690	+1645	KK p. 145 RO p. 146			
 BILBAO AF031 103200 530 x 1670mm	M1	820	1638	1638	1217	1356	+463	+1196				
	M2	986	1804	1804	1382	1522	+463	+1196				
 BILBAO AF032 103210 530 x 1670mm	M1								1 x 	+55	+68	+51
	M2	1293	2111	2111	1688	1829	+680	+1645	KK p. 145			
 PRATO AF041 106200B 150 x 300mm	M1	884	1702	1702	1281	1420	+463	+1196				
	M2	1081	1899	1899	1477	1617	+463	+1196				
 PRATO AF042 106210B 150 x 300mm	M1								1 x 	+55	+68	+51
	M2	1377	2195	2195	1772	1913	+680	+1645	KK p. 145 RO p. 146			

 Min. afmetingen bij inbouw. Bij **magnetude***: afhankelijk van de afmetingen A, B, C, D.
 Dim. mini pour pose en feuillure. En **magnetude*** : dépend des dimensions A, B, C, D.

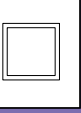
**!!! SUPPLEMENT !!!
magnetude**













Voor PVC WIT SCHRIJNWERK:
basisprijs kolom RAL POEDER.
Pour CHASSIS PVC BLANC :
colonne RAL POUDRE
comme prix de base.

						SUPPLEMENT per paneel par panneau			opties glas / options vitrage  p. 12-13					
M1 1 ZIJDE MOTIEF MOTIF 1 FACE M2 2 ZIJDEN MOTIEF MOTIF 2 FACES	PVC wit blanc • beige crème • 120 140 150	EXT folie filmé • INT wit blanc • beige crème	EXT folie filmé • INT folie filmé	RAL poeder poudre •  p. 172-174	RAL pistool pistolet	SUPPL. magnetude		glas vormen • forme du vitrage	gelaagd 33.2 • feuilleté 33.2	sablé met klare boord • sablé avec bord clair	coating 1,1			
						1 ZIJDE FACE •  p. 7-11	2 ZIJDEN FACES •  p. 7-11				met kern ISOL+ , MU20 of HDP25 • avec âme ISOL+ , MU20 ou HDP25			
▼ buitenaanzicht vue extérieure						900x2100x37 mm	900x2100x36 mm	900x2100x36 mm	900x2100x36 mm	900x2100x36 mm	≤ 990x2190 mm	≤ 990x2190 mm		
 PRATO AF043 106300B  150 x 300mm	M1	951	1769	1769	1346	1487	+463	+1196						
	M2	1175	1993	1993	1572	1713	+463	+1196						
 PRATO AF044 106330B  150 x 300mm	M1								3 x 	+165	+205	+153		
	M2	1871	2689	2689	2267	2407	+927	+2544	KK p. 145 RO p. 146					
 PRATO AF045 106400B  150 x 300mm	M1	951	1769	1769	1346	1487	+463	+1196						
	M2	1175	2019	2019	1572	1713	+463	+1196						
 PRATO AF046 106420B  150 x 300mm	M1								2 x 	+110	+137	+102		
	M2	1509	2327	2327	1905	2047	+780	+2095	KK p. 145					
 PRATO AF047 106102B  150 x 105mm	M1	537	1017	1017	769	853								
	M2	664	1145	1145	898	979								
 PRATO AF048 106400B  150 x 300mm	M1	951	1769	1769	1346	1487	+463	+1196						
	M2	1175	2019	2019	1572	1713	+463	+1196						

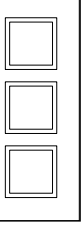
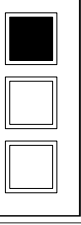
 Min. afmetingen bij inbouw. Bij **magnetude***: afhankelijk van de afmetingen A, B, C, D.
Dim. mini pour pose en feuillure. En **magnetude***: dépend des dimensions A, B, C, D.

**!!! SUPPLEMENT !!!
magnetude**













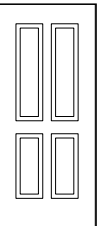

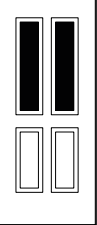

Voor PVC WIT SCHRIJNWERK:
basisprijs kolom RAL POEDER.
Pour CHASSIS PVC BLANC :
colonne RAL POUDRE
comme prix de base.

						SUPPLEMENT per paneel par panneau			opties glas / options vitrage  p. 12-13			
M1 1 ZIJDE MOTIEF MOTIF 1 FACE M2 2 ZIJDEN MOTIEF MOTIF 2 FACES ▼ buitenaanzicht vue extérieure	PVC wit blanc • beige crème • 120 140 150	EXT folie filmé • INT wit blanc • beige crème	EXT folie filmé • INT folie filmé	RAL poeder poudre •  p. 172-174	RAL pistool pistolet	SUPPL. magnetude		glas vormen • forme du vitrage	gelaagd 33.2 • feuilleté 33.2	sablé met klare boord • sablé avec bord clair	coating 1,1	
						1 ZIJDE FACE •  p. 7-11	2 ZIJDEN FACES •  p. 7-11				met kern ISOL+ , MU20 of HDP25 • avec âme ISOL+ , MU20 ou HDP25	
		900x2100x37 mm	900x2100x36 mm	900x2100x36 mm	900x2100x36 mm	900x2100x36 mm	≤ 990x2190 mm	≤ 990x2190 mm				
 PORTO AF051 102100 570 x 1670mm	M1	867	1685	1685	1262	1403	+463	+1196				
	M2	1072	1890	1890	1469	1610	+463	+1196				
 PORTO AF052 102110 570 x 1670mm	M1								1 x 	+55	+68	+51
	M2	1436	2254	2254	1833	1972	+673	+1645	KK p. 145 RO p. 146			
 DOREA AF061 102200 530 x 1720mm	M1	867	1685	1685	1262	1403	+463	+1196				
	M2	1072	1890	1890	1469	1610	+463	+1196				
 DOREA AF062 102210 530 x 1720mm	M1								1 x 	+55	+68	+51
	M2	1436	2254	2254	1833	1972	+654	+1645	KK p. 145 RO p. 146			
 DOREA AF063 102220 530 x 1720mm	M1								2 x 	+110	+137	+102
	M2	1556	2374	2374	1953	2094	+793	+2095	KK p. 145			
 DOREA AF064 102230 530 x 1720mm	M1								3 x 	+165	+205	+153
	M2	1707	2524	2524	2103	2243	+929	+2544	KK p. 145			

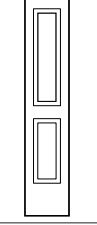
 Min. afmetingen bij inbouw. Bij **magnetude***: afhankelijk van de afmetingen A, B, C, D.
Dim. mini pour pose en feuillure. En **magnetude***: dépend des dimensions A, B, C, D.

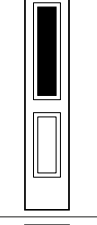
**!!! SUPPLEMENT !!!
magnetude**

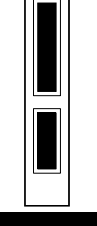











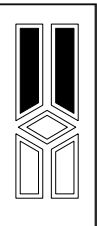

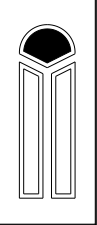
Voor PVC WIT SCHRIJNWERK:
basisprijs kolom RAL POEDER.
Pour CHASSIS PVC BLANC :
colonne RAL POUDRE
comme prix de base.

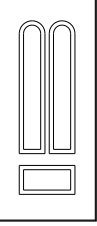
						SUPPLEMENT per paneel par panneau			opties glas / options vitrage  p. 12-13			
M1 1 ZIJDE MOTIEF MOTIF 1 FACE M2 2 ZIJDEN MOTIEF MOTIF 2 FACES		PVC wit blanc • beige crème • 120 140 150	EXT folie filmé • INT wit blanc • beige crème	EXT folie filmé • INT folie filmé	RAL poeder poudre • RAL pistool pistolet • p. 172-174	SUPPL. magnetude		glas vormen • forme du vitrage	gelaagd 33.2 • feuilleté 33.2	sablé met klare board • sablé avec bord clair	coating 1,1 • met kern ISOL+ , MU20 of HDP25 • avec âme ISOL+ , MU20 ou HDP25	
						1 ZIJDE FACE  p. 7-11	2 ZIJDEN FACES  p. 7-11					≤ 990x2190 mm
▼ buitenaanzicht vue extérieure		900x2100x37 mm	900x2100x36 mm	900x2100x36 mm	900x2100x36 mm	900x2100x36 mm	≤ 990x2190 mm	≤ 990x2190 mm				
 PRAAG AF071 101500  570 x 1670mm	M1	892	1710	1710	1287	1428	+463	+1196				
	M2	1083	1927	1927	1480	1621	+463	+1196				
 PRAAG AF072 101520  570 x 1670mm	M1								2 x 	+110	+137	+102
	M2	1417	2235	2235	1813	1955	+783	+2095	SG p. 147 KK p. 145			
 PRAAG AF073 101540  570 x 1670mm	M1								4 x 	+220	+274	+204
	M2	1664	2482	2482	2060	2202	+1034	+2994	SG p. 147 KK p. 145			
 PRAAG AF074 101509  270 x 1670mm	M1	648	1463	1463	1043	1183						
	M2	820	1635	1635	1213	1355						
 PRAAG AF075 101519  270 x 1670mm	M1								1 x 	+55	+68	+51
	M2	1114	1929	1929	1509	1650			SG p. 147 KK p. 145			
 PRAAG AF076 101529  270 x 1670mm	M1								2 x 	+110	+137	+102
	M2	1206	2020	2020	1601	1740			KK p. 145			

 Min. afmetingen bij inbouw. Bij **magnetude***: afhankelijk van de afmetingen A, B, C, D.
Dim. mini pour pose en feuillure. En **magnetude***: dépend des dimensions A, B, C, D.

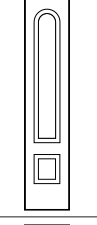
**!!! SUPPLEMENT !!!
magnetude**

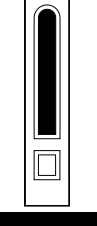
Voor PVC WIT SCHRIJNWERK:
basisprijs kolom RAL POEDER.
Pour CHASSIS PVC BLANC:
colonne RAL-POUDRE
comme prix de base.









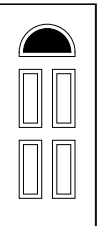

						SUPPLEMENT per paneel par panneau					
M1 1 ZIJDE MOTIEF MOTIF 1 FACE M2 2 ZIJDEN MOTIEF MOTIF 2 FACES ▼ buitenaanzicht vue extérieure	PVC wit blanc • beige crème • 120 140 150	EXT folie filmé • INT wit blanc • beige crème	EXT folie filmé • INT folie filmé	RAL poeder poudre • p. 172-174	RAL pistool pistolet	SUPPL. magnetude		opties glas / options vitrage  p. 12-13			
						1 ZIJDE FACE  p. 7-11	2 ZIJDEN FACES  p. 7-11	glas vormen • forme du vitrage	gelaagd 33.2 • feuilleté 33.2	sablé met klare board • sablé avec bord clair	coating 1,1 met kern ISOL+ , MU20 of HDP25 • avec âme ISOL+ , MU20 ou HDP25
						≤ 990x2190 mm	≤ 990x2190 mm				
 PARIJS AF081 101720  570 x 1670mm	M1							2 x 	+130	+235	+102
	M2	1651	2469	2469	2047	2187	+829	+2168	SG p. 147 KK p. 145		
 YORK AF091 102410  570 x 1670mm	M1							1 x 	+65	+108	+51
	M2	1450	2268	2268	1846	1988	+671	+1713	SG p. 147 KK p. 145		
 MADRID AF101 102800  570 x 1670mm	M1	867	1685	1685	1262	1403	+463	+1196			
	M2	1072	1890	1890	1469	1610	+463	+1196			
 MADRID AF102 102820  570 x 1670mm	M1							2 x 	+130	+216	+102
	M2	1417	2235	2235	1813	1955	+863	+2228	SG p. 147 KK p. 145		
 MADRID AF103 102809  270 x 1670mm	M1	630	1442	1442	1023	1162					
	M2	812	1624	1624	1204	1345					
 MADRID AF104 102819  270 x 1620mm	M1							1 x 	+65	+108	+51
	M2	1114	1929	1929	1509	1650			SG p. 147 KK p. 145		

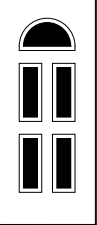
 Min. afmetingen bij inbouw. Bij **magnetude***: afhankelijk van de afmetingen A, B, C, D.
 Dim. mini pour pose en feuillure. En **magnetude*** : dépend des dimensions A, B, C, D.

**!!! SUPPLEMENT !!!
magnetude**

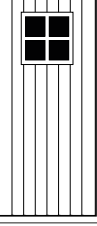
Voor PVC WIT SCHRIJNWERK:
basisprijs kolom RAL POEDER.
Pour CHASSIS PVC BLANC :
colonne RAL-POUDRE
comme prix de base.

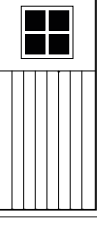

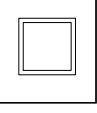
SUPPLEMENT per paneel | par panneau

<p>M1 1 ZIJDE MOTIEF MOTIF 1 FACE</p> <p>M2 2 ZIJDEN MOTIEF MOTIF 2 FACES</p> <p>▼ buitenaanzicht vue extérieure</p>	<p>PVC wit blanc • beige crème • 120 140 150</p>	<p>EXT folie filmé • INT wit blanc • beige crème</p>	<p>EXT folie filmé • INT folie filmé</p>	<p>RAL poeder poudre • p. 172-174</p>	<p>RAL pistool pistolet</p>	SUPPL. magnetude		opties glas / options vitrage ⓘ p. 12-13			
						1 ZIJDE FACE • p. 7-11	2 ZIJDEN FACES • p. 7-11	glas vormen • forme du vitrage	gelaagd 33.2 • feuilleté 33.2	sablé met klare boord • sablé avec bord clair	coating 1,1 • met kern ISOL+ , MU20 of HDP25 • avec âme ISOL+ , MU20 ou HDP25
						≤ 990x2190 mm	≤ 990x2190 mm				
 <p>VENETIE AF111 102010</p> <p>570 x 1670mm</p>	M1							1 x 	+65	+108	+51
	M2	1386	2204	2204	1782	1924	+659	+1779	SG p. 147		
 <p>VENETIE AF112 102050</p> <p>570 x 1670mm</p>	M1							4 x  1 x 	+285	+382	+255
	M2	1818	2636	2636	2214	2356	+1154	+3577	SG p. 147 KK p. 145		
 <p>ANDORRA AF121 104110</p> <p>530 x 530mm</p>	M1							1 x 	+55		+51
	M2	1256	2074	2074	1651	1792	+654	+1645			
 <p>LIECHTENSTEIN AF131 104210</p> <p>I ↔ 130 mm</p> <p>530 x 530mm</p>	M1							1 x 	+55		+51
	M2	1626	2468	2468	2022	2162	+654	+1645			
 <p>BELVEDERE AF141 105110</p> <p>II ↔ 137 mm</p> <p>530 x 530mm</p>	M1							1 x 	+55		+51
	M2	1626	2468	2468	2022	2162	+654	+1645			
 <p>PORTO OND AF151 102102</p> <p>570 x 570mm</p>	M1	434	843	843	631	702					
	M2	536	945	945	735	804					

Min. afmetingen bij inbouw. Bij **magnetude***: afhankelijk van de afmetingen A, B, C, D.
Dim. mini pour pose en feuillure. En **magnetude***: dépend des dimensions A, B, C, D.

!!! SUPPLEMENT !!! magnetude

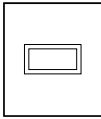
Voor PVC WIT SCHRIJNWERK:
basisprijs kolom RAL POEDER.
Pour CHASSIS PVC BLANC:
colonne RAL-POUDRE
comme prix de base.

						SUPPLEMENT per paneel par panneau						
M1 1 ZIJDE MOTIEF MOTIF 1 FACE M2 2 ZIJDEN MOTIEF MOTIF 2 FACES ▼ buitenaanzicht vue extérieure	PVC wit blanc • beige crème • 120 140 150	EXT folie filmé • INT wit blanc • beige crème	EXT folie filmé • INT folie filmé	RAL poeder poudre • p. 172-174	RAL pistool pistolet	SUPPL. magnetude		opties glas / options vitrage ⓘ p. 12-13				
	900x2100x37 mm	900x2100x36 mm	900x2100x36 mm	900x2100x36 mm	900x2100x36 mm	1 ZIJDE FACE • p. 7-11	2 ZIJDEN FACES • p. 7-11	glas vormen • forme du vitrage	gelaagd 33.2 • feuilleté 33.2	sablé met klare boord • sablé avec bord clair	coating 1,1 met kern ISOL+ , MU20 of HDP25 • avec âme ISOL+ , MU20 ou HDP25	
	≤ 990x2190 mm	≤ 990x2190 mm										
 MADRID OND AF161 102802 350 x 570mm	M1	434	843	843	631	702						
	M2	552	960	960	750	819						
	M1											
	M2											
	M1											
	M2											
						!!! SUPPLEMENT !!! magnetude Voor PVC WIT SCHRUIWWERK: basisprijs kolom RAL POEDER. Pour CHASSIS PVC BLANC : colonne RAL POUDRE comme prix de base.						
ENKEL magnetude • D'OFFICE magnetude standaard ft standard 990 x 2190 ▼ buitenaanzicht vue extérieure		VLEUGELOVERDEKKEND CACHE-OUVRANT magnetude						opties glas / options vitrage ⓘ p. 12-13				
		PVC wit blanc • beige crème • 120 140 150	EXT folie filmé • INT wit blanc • beige crème	EXT folie filmé • INT folie filmé	RAL poeder poudre • p. 172-174	RAL pistool pistolet			glas vormen • forme du vitrage	gelaagd 33.2 • feuilleté 33.2	sablé met klare boord • sablé avec bord clair	
 BEIROET AF181 570 x 1670mm	M1	3792	4042	4164	3792	4407	Met opendraaiend raampje DRAAI-KIP • Avec fenêtre ouvrante OSCILLO-BATTANT	1 x ■	+55	+68		
	M2											

Min. afmetingen bij inbouw. Bij **magnetude***: afhankelijk van de afmetingen A, B, C, D.
 Dim. mini pour pose en feuillure. En **magnetude*** : dépend des dimensions A, B, C, D.

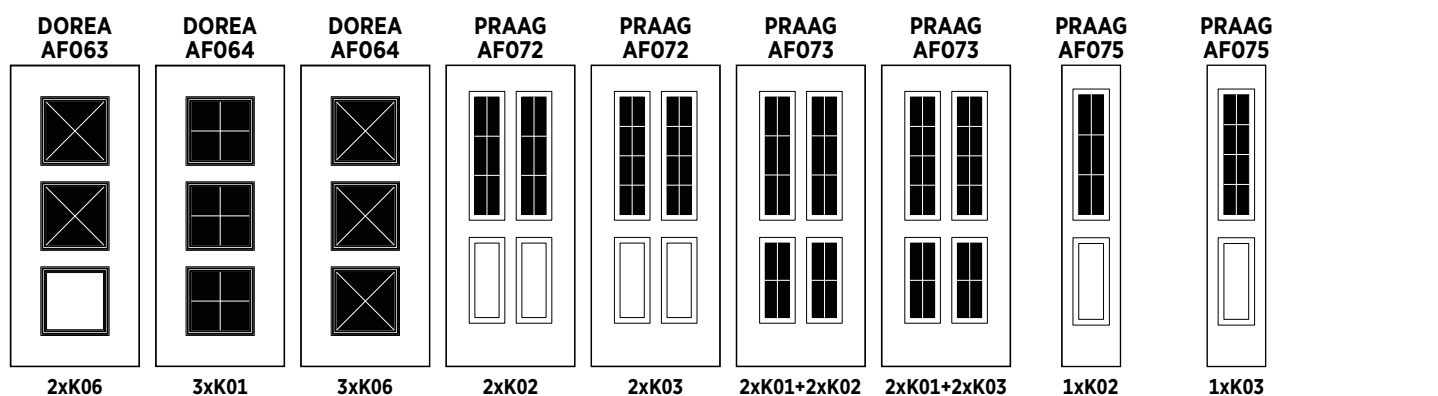
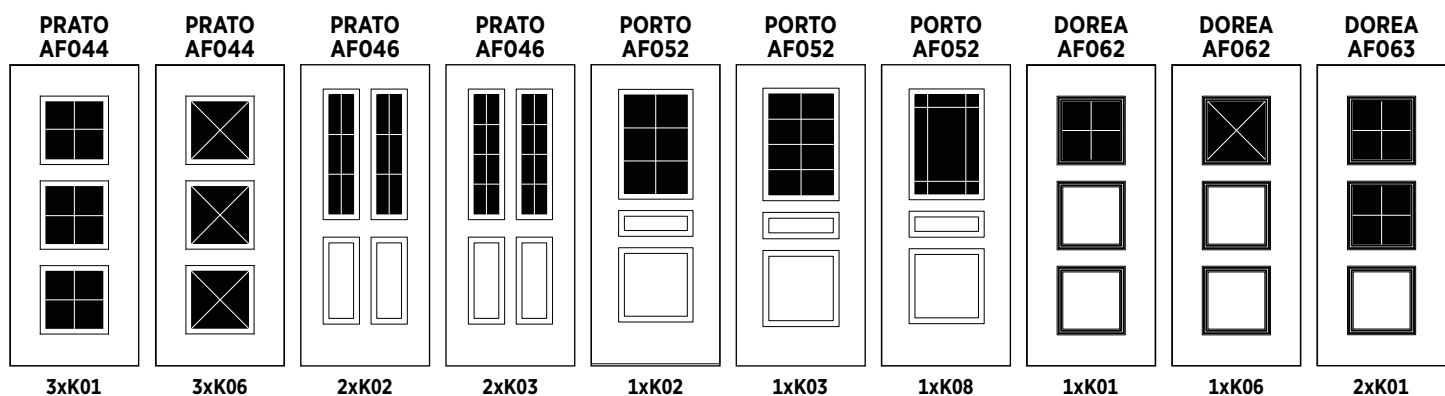
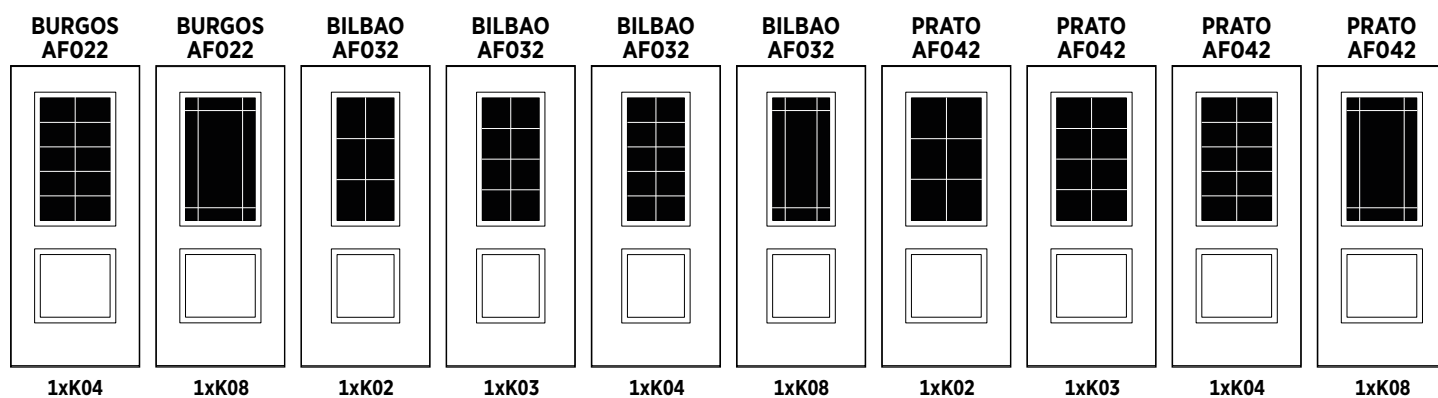
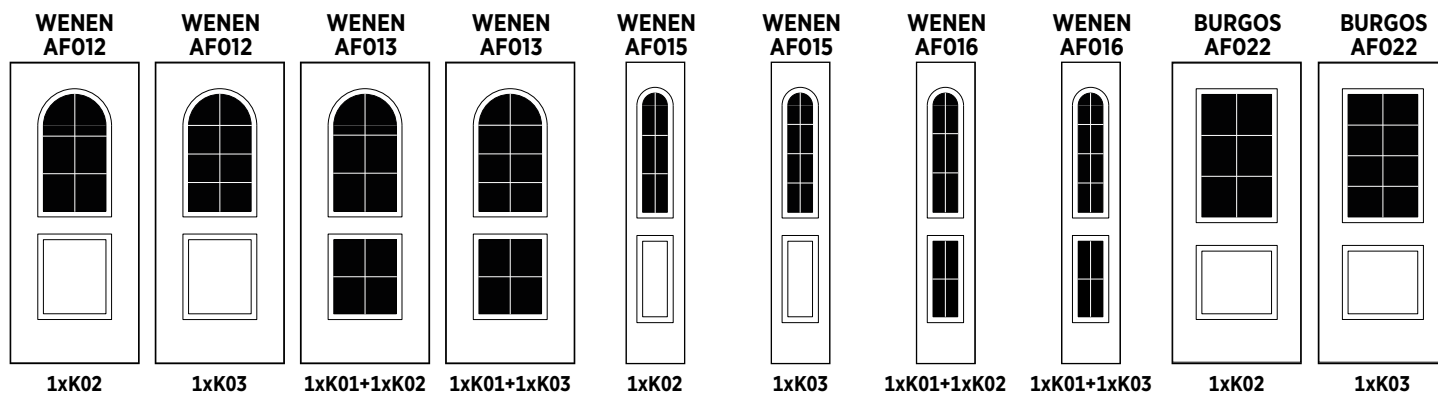

PRAAG AF076	PRAAG AF076	PARIJS AF081	PARIJS AF081	MADRID AF102	MADRID AF104	VENETIE AF111	VENETIE AF112
1xK01+1xK02	1xK01+1xK03	2xK02	2xK03	2xK04	1xK04	1xK05	4xK01+1xK05



RO - cirkels/ruiten | cercles/diamants

1 x = € 785

1 x = € 1082

RO - eigen ontwerp | propre design

1 x = € 1231

1 x = € 1548

ROOSTER INBOUW | GRILLE INTÉGRÉ DANS LE VITRAGE ***
standaard zwart gelakt | laqué noir standard

*** Rooster mogelijk indien de breedte van de kader groter is dan:
Grille possible si la largeur du cadre est plus grand que :
---> 380 mm

Dikte paneel moet minstens zijn:
L'épaisseur du panneau doit être de minimum :
Niet gelaagd | Non feuilleté ---> 36 mm
1Z gelaagd | 1 face feuilleté ---> 40 mm
2Z gelaagd | 2 faces feuilleté ---> 44 mm

Enkel mogelijk in bovenste glas.
Uniquement possible dans le vitrage supérieur.

De inbouwroosters zijn ter illustratie. | Grilles intégrées à titre indicatif.

suppl. - SIERGLAZEN | VITRAGES DECORATIFS

**WENEN
AF012**

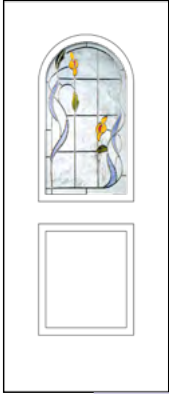

F0121 € 878

**WENEN
AF013**

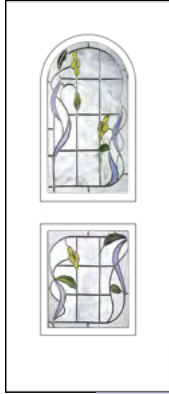

F0131 € 1486

**WENEN
AF015**



F0151 € 878

**WENEN
AF016**



F0161 € 1486

**PRAAG
AF072**

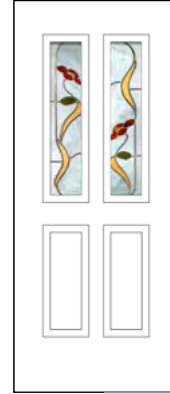

F0721 € 899

**PRAAG
AF075**



F0751 € 385

**PARIJS
AF081**



F0811 € 899

**YORK
AF091**

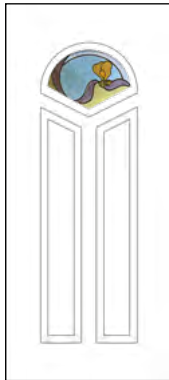

F0911 € 355

**MADRID
AF102**



F1021 € 1083

**MADRID
AF104**



F1041 € 454

**VENETIE
AF111**

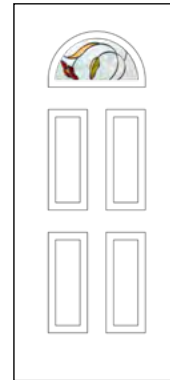

F1111 € 353

**VENETIE
AF112**

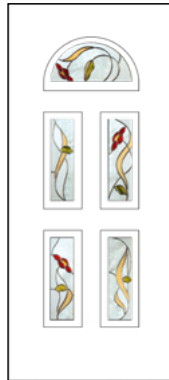

F1121 € 1311

a appendix

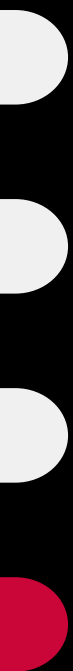

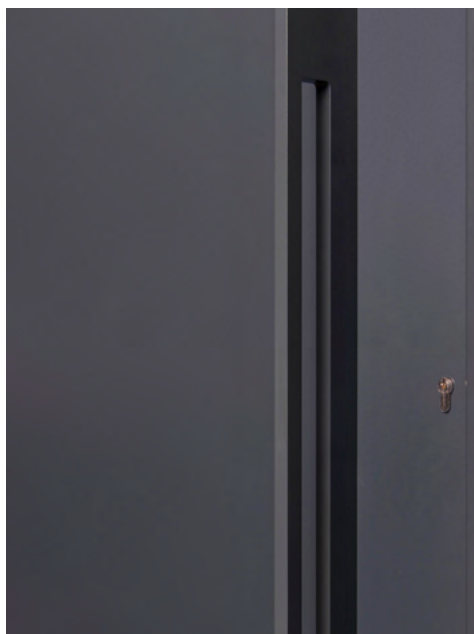
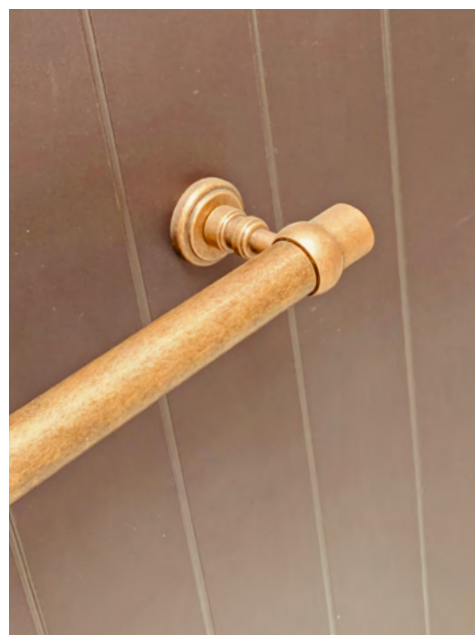
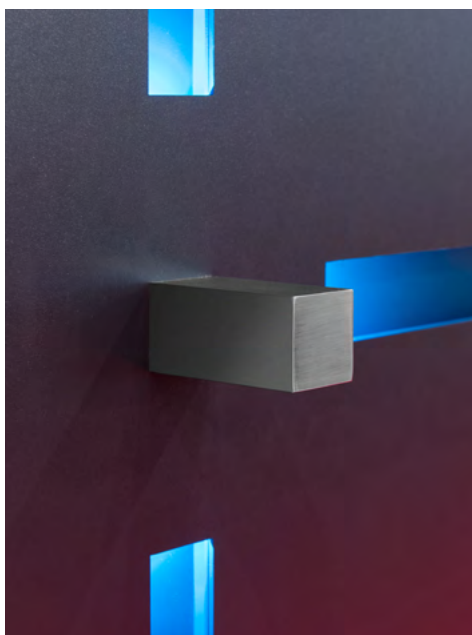



VT

**VEROUDERDE
TINKLEUR**

**COULEUR
ÉTAIN VIEILLI**

art. DB3342VT

Veiligheidscilinderplaat
Cache cylindre sécurité

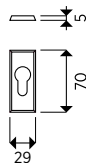

€ 34

art. DB2370VT

Tin deurtrekker
Tirant en étain

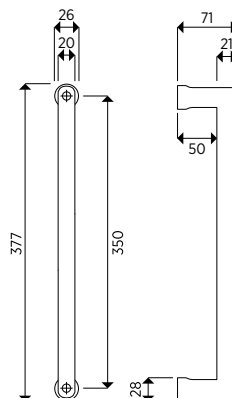

€ 244

art. DB2371VT

Tin deurtrekker
Tirant en étain

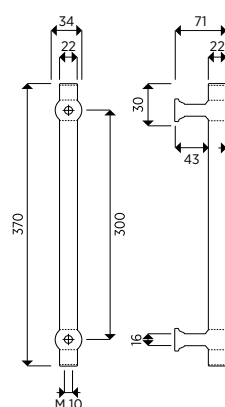

€ 244



VZ

**VEROUDERD
ZWART**

**COULEUR
NOIR VIEILLI**

art. DB3342VZ

Veiligheidscilinderplaat
Cache cylindre sécurité

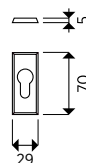

€ 34

art. DB2370VZ

Zwarte deurtrekker
Tirant en noir

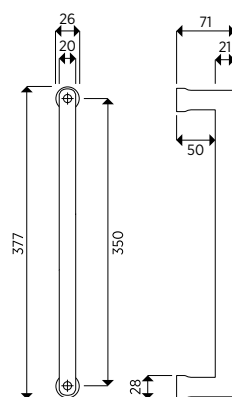

€ 244

art. DB2371VZ

Zwarte deurtrekker
Tirant en noir

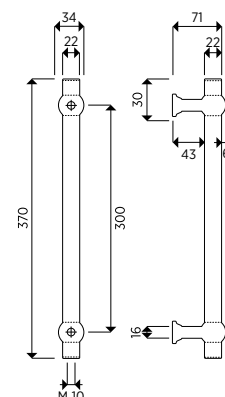

€ 244



RK

**ROOD
KOPER**

**CUIVRE
ROUGE**

art. DB3342RK

Veiligheidscilinderplaat
Cache cylindre sécurité

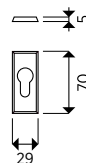

€ 34

art. DB2370RK

Rood koper deurtrekker
Tirant en cuivre rouge

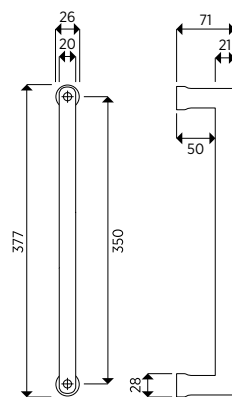

€ 244

art. DB2371RK

Rood koper deurtrekker
Tirant en cuivre rouge

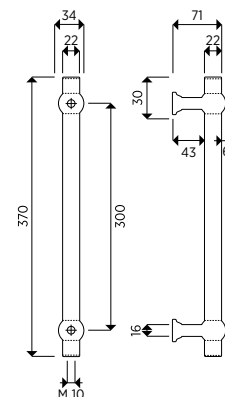

€ 244



art. DB2350VB
Bronzen deurtrekker
Tirant en bronze

€ 141

art. DB2351VB
Bronzen deurtrekker
Tirant en bronze

€ 166

art. DB2352VB
Bronzen deurtrekker
Tirant en bronze

€ 212

art. DB2353VB
Bronzen deurtrekker
Tirant en bronze

€ 275

art. DB2354VB
Bronzen deurtrekker
Tirant en bronze

€ 371

art. DB4355VB
Bronzen brievenbusklep
Clapet en bronze

Te combineren met | A combiner avec
art. DB4358ZW & art. DB4357IN/ZW

€ 219

art. DB3356VB
Bronzen cilinderplaat
Cache cylindre en bronze

€ 21

art. DB1359VB
Bronzen deurtrekker
Tirant en bronze

€ 112

art. DB1360VB
Bronzen deurtrekker
Tirant en bronze

€ 112



art. DB6028PO
Koperen spionooog
(voor deurdikte 17-31 mm)
Viseur optique en laiton poli
(pour épaisseur porte 17-31 mm)

€ 26

art. DB6029PO
Koperen spionooog
(voor deurdikte 33-63 mm)
Viseur optique en laiton poli
(pour épaisseur porte 33-63 mm)

€ 34

art. DB1301PO
Koperen deurkruk
Poignée en laiton poli

€ 75

art. DB1302PO

Koperen deurkruk
Poignée en laiton poli

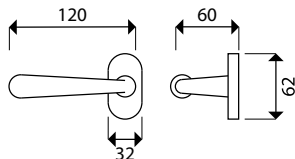

€ 75

art. DB2322PO

Koperen deurtrekker
Tirant en laiton poli

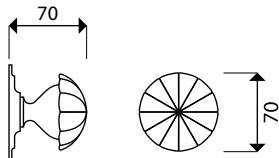

€ 81

art. DB2335PO

Koperen deurtrekker
Tirant en laiton poli

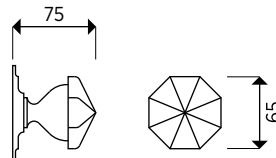

€ 98

art. DB3303PO

Koperen cilinderplaat
Cache cylindre en laiton poli



€ 17

art. DB2315PO

Koperen deurtrekker
Tirant en laiton poli

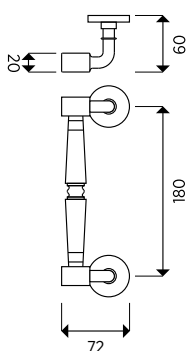

€ 165

art. DB2332PO

Koperen deurtrekker
Tirant en laiton poli

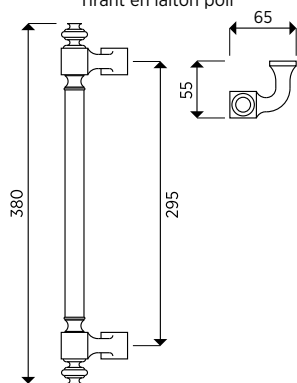

€ 138

art. DB2333PO

Koperen deurtrekker
Tirant en laiton poli

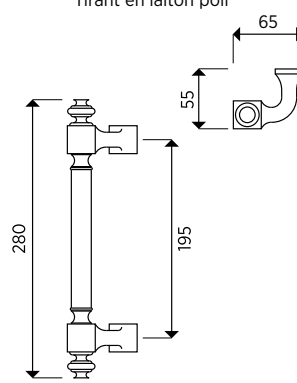

€ 141

art. DB3304PO

Koperen cilinderplaat
Cache cylindre en laiton poli

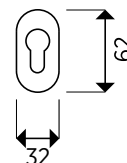

€ 22

art. DB3342PO

Koperen cilinderplaat
Cache cylindre en laiton poli

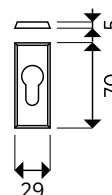

€ 39

OPGELET! deurbeslag **PO** beschikbaar tot zolang de voorraad strekt
ATTENTION! quincaillerie **PO** disponible jusqu'à épuisement du stock

art. DB1301BR

Bronzen deurkruk
Poignée en bronze

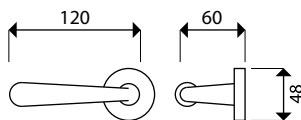

€ 75

art. DB1302BR

Bronzen deurkruk
Poignée en bronze

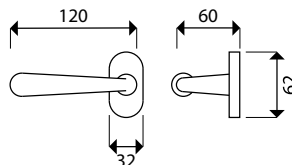

€ 75

art. DB2322BR

Bronzen deurtrekker
Tirant en bronze

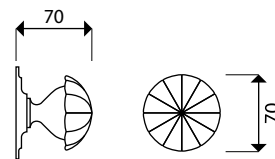

€ 73

art. DB2315BR

Bronzen deurtrekker
Tirant en bronze

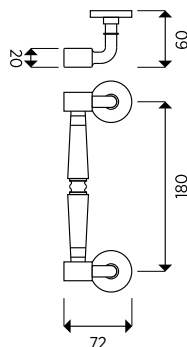

€ 151

art. DB2332BR

Bronzen deurtrekker
Tirant en bronze

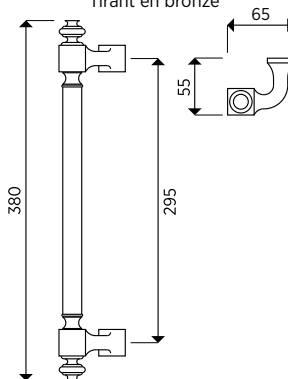

€ 138

art. DB2333BR

Bronzen deurtrekker
Tirant en bronze

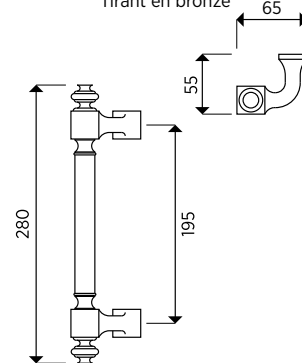

€ 141

BR

BRONS

BRONZE

OPGELET!
deurbeslag **BR** beschikbaar tot zolang de voorraad strekt

ATTENTION!
quincaillerie **BR** disponible jusqu'à épuisement du stock

art. DB3303BR

Bronzen cilinderplaat
Cache cylindre en bronze



€ 34

art. DB3304BR

Bronzen cilinderplaat
Cache cylindre en bronze

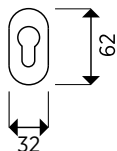

€ 34

art. DB3342BR

Bronzen cilinderplaat
Cache cylindre en bronze

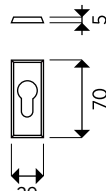

€ 34

OPGELET!
deurbeslag **BR** beschikbaar tot
zolang de voorraad strekt

ATTENTION!
quincaillerie **BR** disponible
jusqu'à épuisement du stock



art. DB2350SN

Tinnen deurtrekker
Tirant en étain

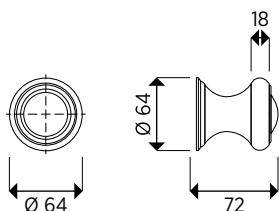

€ 141

art. DB2351SN

Tinnen deurtrekker
Tirant en étain

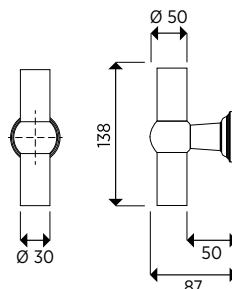

€ 166

art. DB2352SN

Tinnen deurtrekker
Tirant en étain

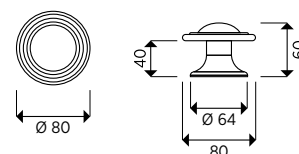

€ 212

art. DB2353SN

Tinnen deurtrekker
Tirant en étain

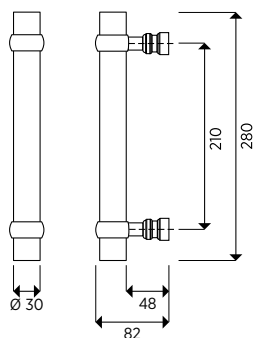

€ 275

art. DB2354SN

Tinnen deurtrekker
Tirant en étain

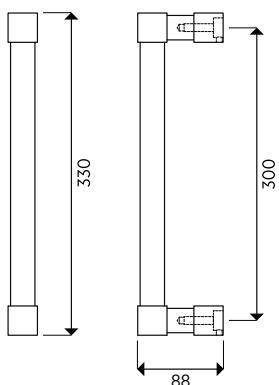

€ 371

art. DB4355SN

Tinnen brievenbusklep
Clapet en étain

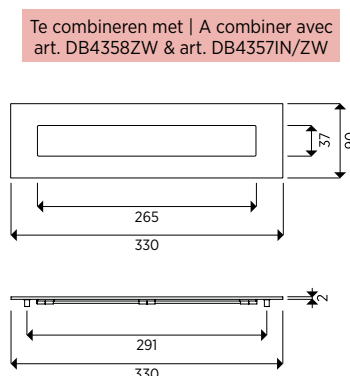

€ 219

art. DB3356SN

Tinnen cilinderplaat
Cache cylindre en étain

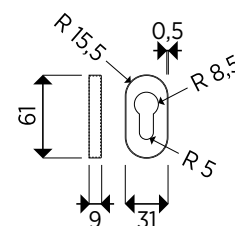

€ 21

Te combineren met | A combiner avec
art. DB4358ZW & art. DB4357IN/ZW

art. DB1359SN

Bronzen deurtrekker
Tirant en bronze

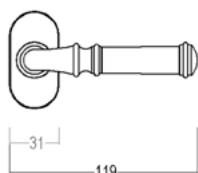

€ 112

**NIEUW
NOUVEAU**

art. DB1360SN

Bronzen deurtrekker
Tirant en bronze

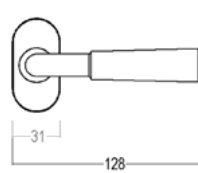

€ 112

ZW
ZWART
NOIR

art. DB2350ZW
Zwarte deurtrekker
Tirant en noir

€ 141

art. DB2351ZW
Zwarte deurtrekker
Tirant en noir

€ 166

art. DB2352ZW
Zwarte deurtrekker
Tirant en noir

€ 212

art. DB3201ZW
Zwarte cilinderplaat ovaal
Cache cylindre en noir ovale

€ 21

art. DB1216ZW
Inox deurruk
Poignée en inox

€ 39

art. DB2353ZW
Zwarte deurtrekker
Tirant en noir

€ 275

art. DB2354ZW
Zwarte deurtrekker
Tirant en noir

€ 371

art. DB4355ZW*
Zwarte brievenbusklep ext.
Clapet en noir ext

* Te combineren met | A combiner avec
art. DB4358ZW & art. DB4357IN/ZW

art. DB4357ZW*
Zwarte brievenbusklep int.
Clapet en noir int.

* Te combineren met | A combiner avec
art. DB4358ZW & DB4355VB/SN/ZW/IN

€ 219

€ 112

art. DB2211ZW

NIEUW NOUVEAU

€ 347

STANDAARD ZWART (ZW).
Ook verkrijgbaar in PL.
RAL kleur naar keuze. Zie p. 163.

NOIR STANDARD (ZW).
Egalement disponible en PL.
Couleur RAL au choix. Voir p. 163.

art. DB2212ZW

€ 347

art. DB4358ZW
Zwarte tussenschacht
Conduit de liaison en noir

€ 6

art. DB1359ZW
Bronzen deurtrekker
Tirant en bronze

NIEUW NOUVEAU

€ 112

art. DB1360ZW
Bronzen deurtrekker
Tirant en bronze

€ 112

IN
INOX
(AISI 316)

art. DB2123IN

Inox deurtrekker
Tirant en inox

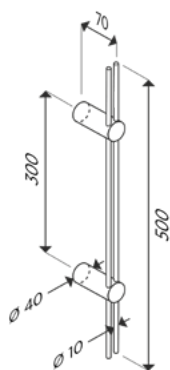

€ 195

art. DB2124IN

Inox deurtrekker
Tirant en inox

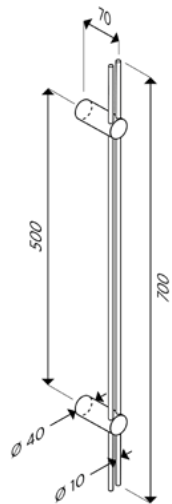

€ 255

art. DB2125IN

Inox deurtrekker
Tirant en inox

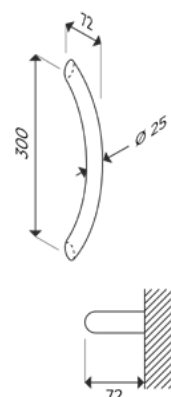

€ 124

art. DB2126IN

Inox deurtrekker
Tirant en inox

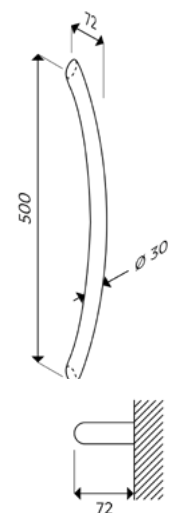

€ 173

art. DB2127IN

Inox deurtrekker
Tirant en inox

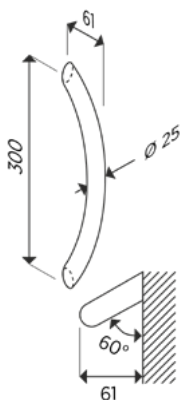

€ 134

art. DB2131IN

Inox deurtrekker
Tirant en inox

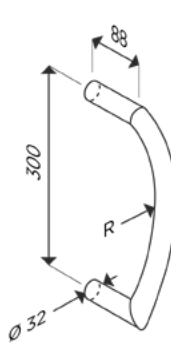

€ 98

art. DB2133IN

Inox deurtrekker
Tirant en inox

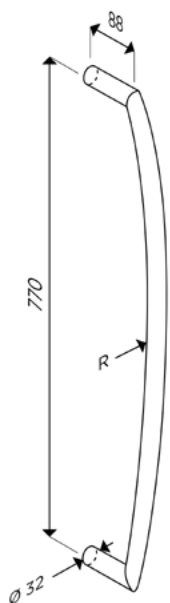

€ 212

art. DB2133IN
passend bij |
cintré comme

- SO131/2
- SO141/2
- SO151/2
- SO161/2
- SO171/2
- SO081
- LD041/2
- MO011/2

art. DB2153IN
passend bij |
cintré comme

- LD081/2
- SX061/2
- SO121/2

art. DB2152IN

Inox deurtrekker
Tirant en inox

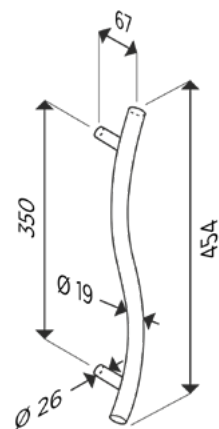

€ 149

art. DB2153IN

Inox deurtrekker
Tirant en inox

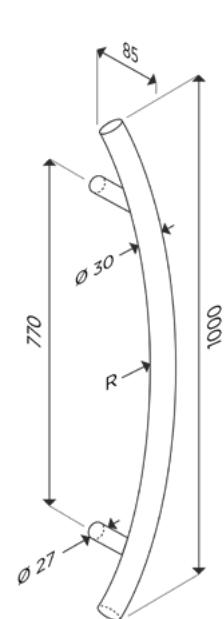

€ 294

art. DB2128IN

Inox deurtrekker
Tirant en inox

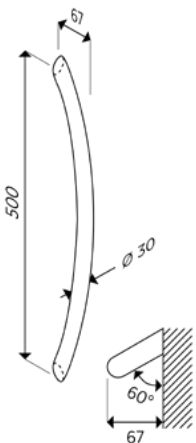

€ 184

art. DB2132IN

Inox deurtrekker
Tirant en inox

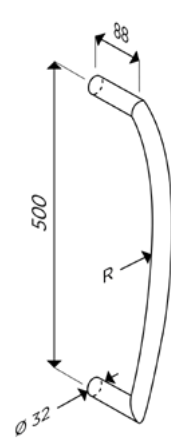

€ 155

art. DB2134IN

Inox deurtrekker
Tirant en inox

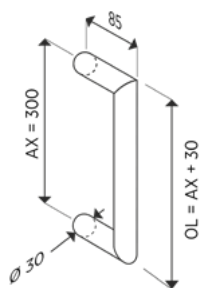

€ 145

art. DB2135IN

Inox deurtrekker
Tirant en inox



€ 198

art. DB2136IN

Inox deurtrekker
Tirant en inox



€ 383

art. DB2140IN

Inox deurtrekker
Tirant en inox

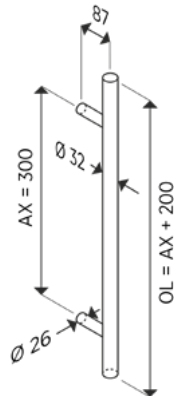

€ 117

art. DB2141IN

Inox deurtrekker
Tirant en inox

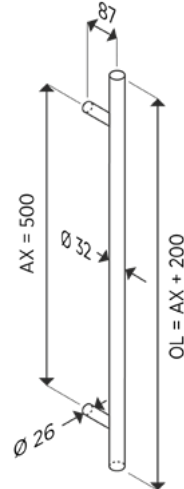

€ 172

art. DB2142IN

Inox deurtrekker
Tirant en inox



€ 198

Maatwerk art.: zie tabel p. 164-165
Art. sur mesure : voir tableau p. 164-165

art. DB2137IN

Inox deurtrekker
Tirant en inox

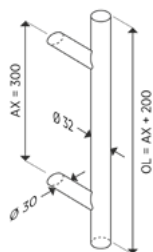

€ 187

art. DB2138IN

Inox deurtrekker
Tirant en inox

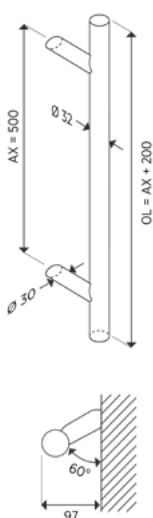

€ 202

art. DB2139IN

Inox deurtrekker
Tirant en inox

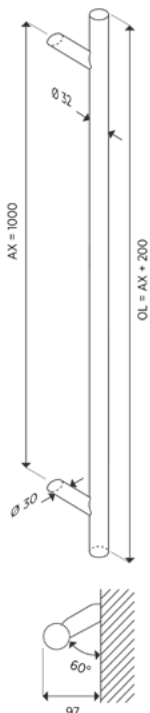

€ 218

art. DB2297IN

Inox deurtrekker
Tirant en inox

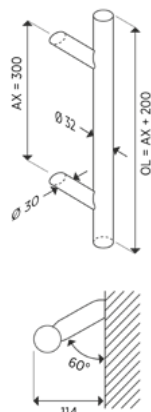

€ 239

art. DB2298IN

Inox deurtrekker
Tirant en inox

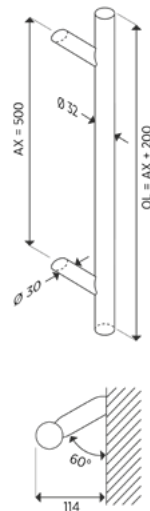

€ 245

art. DB2299IN

Inox deurtrekker
Tirant en inox



€ 358

Maatwerk art.: zie tabel p. 164-165
Art. sur mesure : voir tableau p. 164-165

ART. DB2143IN

Inox deurtrekker
Tirant en inox

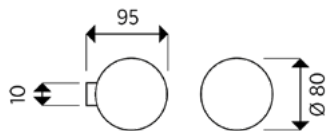

€ 103

art. DB3201IN

Inox cilinderplaat ovaal
Cache cylindre en inox ovale

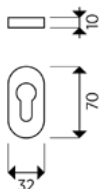

€ 12

art. DB3202IN

Inox cilinderplaat rond
Cache cylindre en inox rond

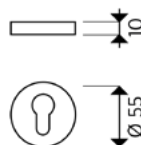

€ 12

art. DB3206IN

Inox veiligheidscilinderplaat
Cache cylindre en inox



€ 187

art. DB1215IN

Inox deurkruk
Poignée en inox

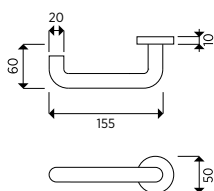

€ 39

art. DB1216IN

Inox deurkruk
Poignée en inox

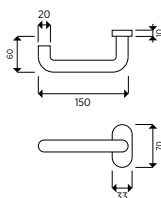

€ 39

art. DB1217IN

Inox deurkruk
Poignée en inox

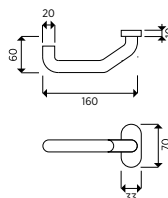

€ 39

art. DB6028IN

Inox spionoog
(voor deurdikte 17-31 mm)
Viseur optique en inox
(pour épaisseur porte 17-31 mm)

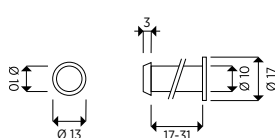

€ 26

art. DB6029IN

Inox spionoog
(voor deurdikte 33-63 mm)
Viseur optique en inox
(pour épaisseur porte 33-63 mm)

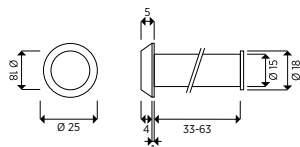

€ 34

art. DB2294IN

Inox deurtrekker (rond)
Tirant en inox (rond)

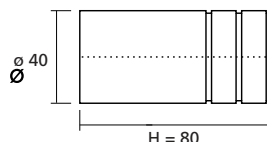

€ 141

art. DB2295IN

Inox deurtrekker (vierkant)
Tirant en inox (carré)

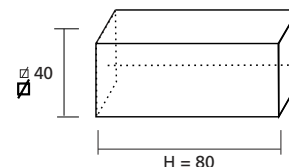

€ 224

art. DB5230IN

Cijfer in inox
Chiffre en inox

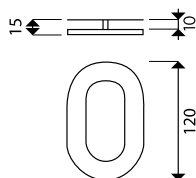

€ 71

art. DB523AIN

Letter in inox
Lettre en inox

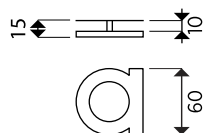

€ 71

art. DB5240IN

Cijfer in inox
Chiffre en inox

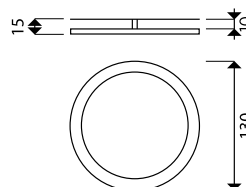

€ 71

art. DB524AIN

Letter in inox
Lettre en inox

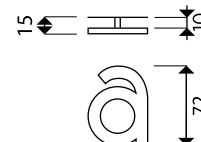

€ 71

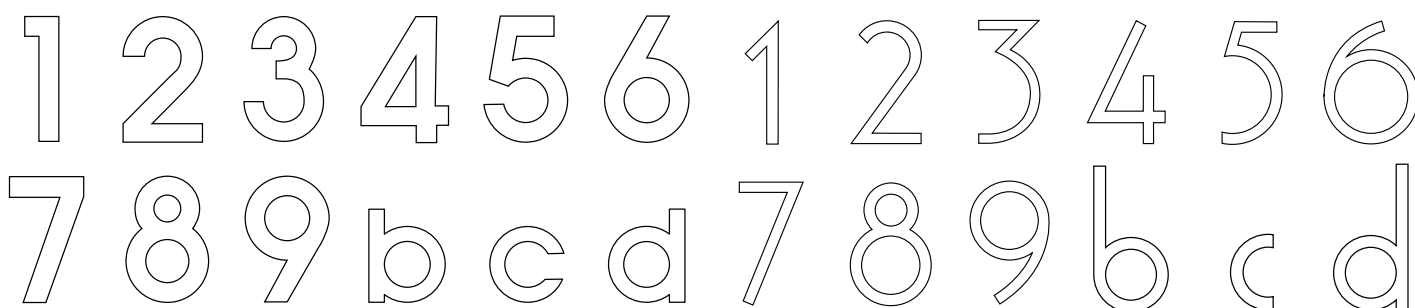

art. DB250IN

Inox deurtrekker
Tirant en inox

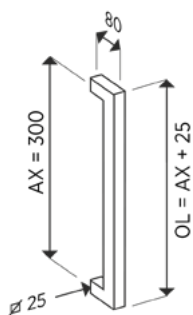

€ 139

art. DB251IN

Inox deurtrekker
Tirant en inox



€ 175

art. DB252IN

Inox deurtrekker
Tirant en inox



€ 368

art. DB253IN

Inox deurtrekker
Tirant en inox

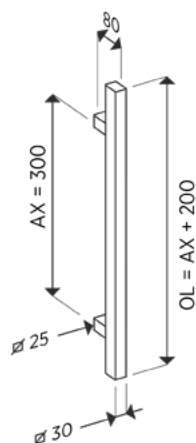

€ 166

art. DB254IN

Inox deurtrekker
Tirant en inox

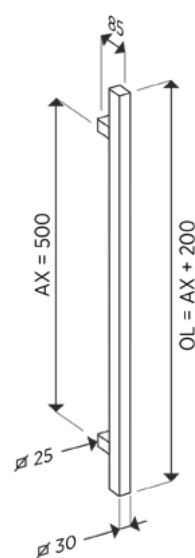

€ 204

art. DB255IN

Inox deurtrekker
Tirant en inox

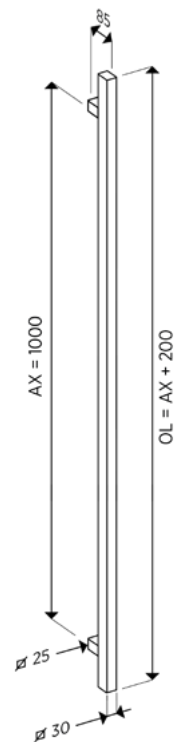

€ 255

Maatwerk art.: zie tabel p. 164-165
Art. sur mesure : voir tableau p. 164-165

art. DB256IN

Inox deurtrekker
Tirant en inox

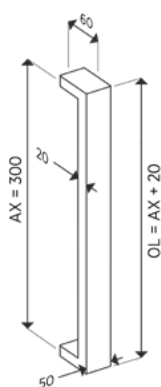

€ 293

art. DB262IN

Inox deurtrekker
Tirant en inox

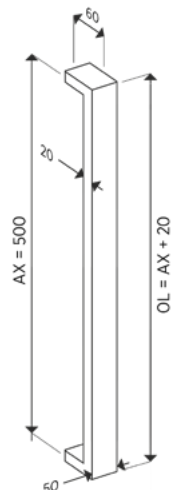

€ 348

art. DB257IN

Inox deurtrekker
Tirant en inox



€ 404

art. DB259IN

Inox deurtrekker
Tirant en inox

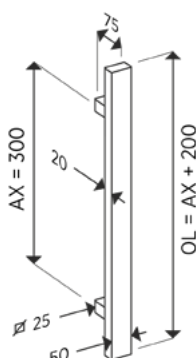

€ 207

art. DB260IN

Inox deurtrekker
Tirant en inox

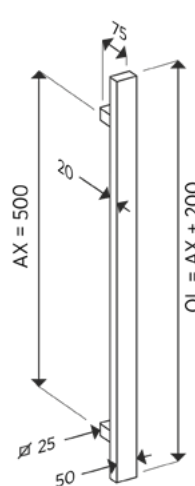

€ 247

art. DB261IN

Inox deurtrekker
Tirant en inox

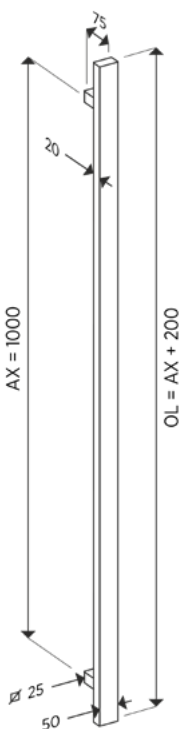

€ 327

art. DB2790IN

Inox deurtrekker
Tirant en inox

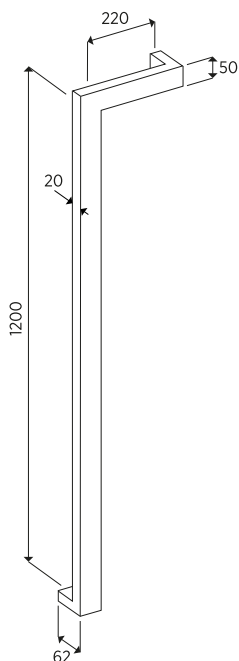

€ 824

art. DB290IN

Inox deurtrekker
Tirant en inox

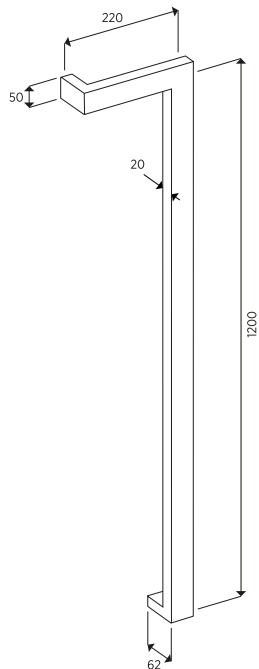

€ 824

art. DB2791IN

Inox deurtrekker
Tirant en inox

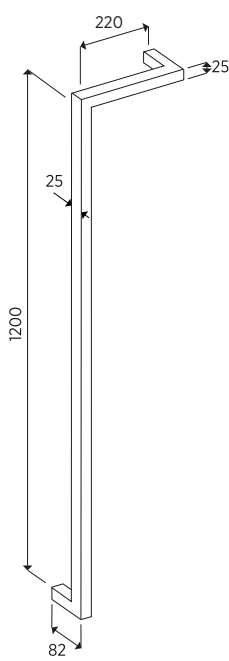

€ 824

art. DB291IN

Inox deurtrekker
Tirant en inox

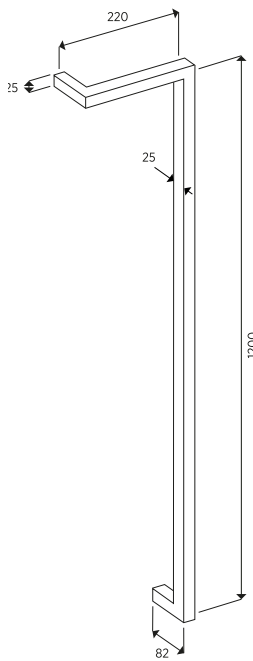

€ 824

art. DB292IN

Inox deurtrekker
Tirant en inox

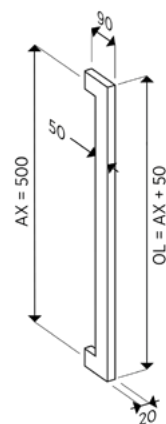

€ 471

art. DB293IN

Inox deurtrekker
Tirant en inox



€ 471

art. DB4357IN

Inox binnenklep
Clapet en inox int

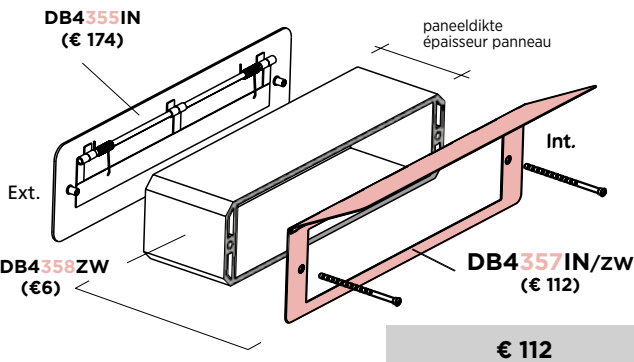

€ 112

art. DB4355IN

Inox brievenbusklep ext.
Clapet en inox ext.

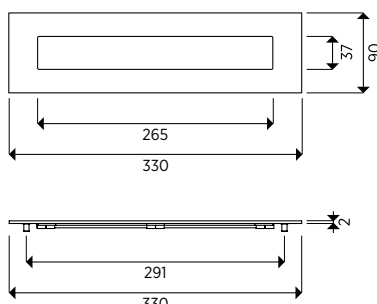

*Te combineren met |
A combiné avec
art. DB4358ZW
& art. DB4357IN

€ 174

Maatwerk art.: zie tabel p. 164-165
Art. sur mesure : voir tableau p. 164-165

art. DB2258IN

Inox deurtrekker
Tirant en inox

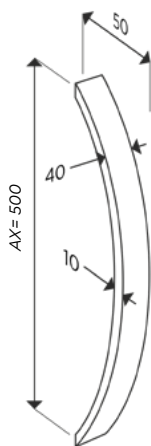

€ 247

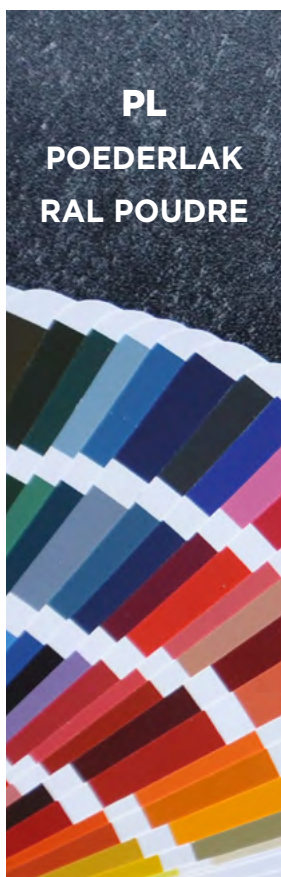

art. DB2790PL	art. DB2290PL	art. DB2791PL	art. DB2291PL
Deurtrekker in poederlak Tirant en ral poudre	Deurtrekker in poederlak Tirant en ral poudre	Deurtrekker in poederlak Tirant en ral poudre	Deurtrekker in poederlak Tirant en ral poudre
€ 1089	€ 1089	€ 1089	€ 1089

art. DB2811PL

€ 501

art. DB2813PL

DETAIL
Doorsnede trekker/
Coupe tirant

€ 501

art. DB2816PL

€ 501

art. DB2817PL

€ 501

art. DB2818PL

€ 501

art. DB2821PL

€ 501

Maatwerk art.: zie tabel p. 164-165
Art. sur mesure : voir tableau p. 164-165

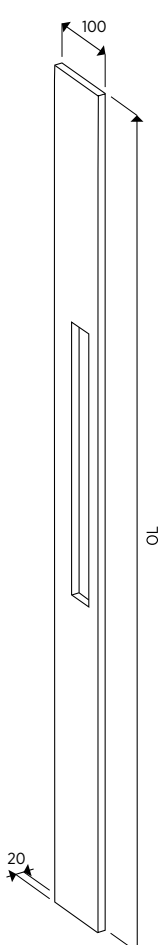
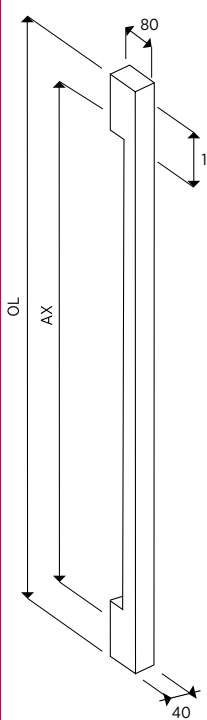
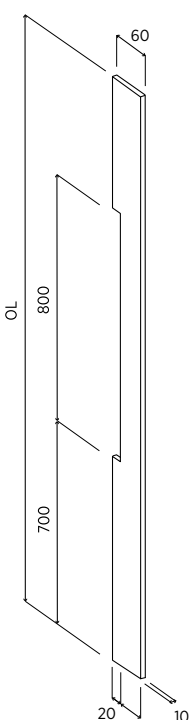
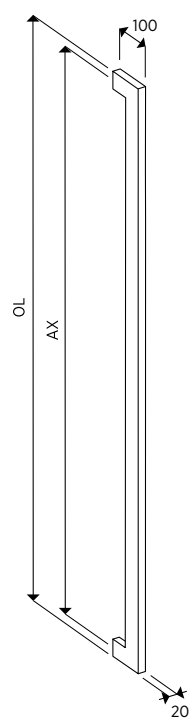
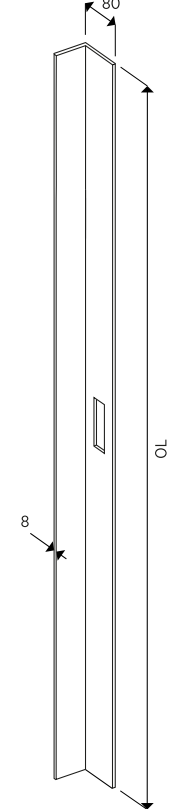
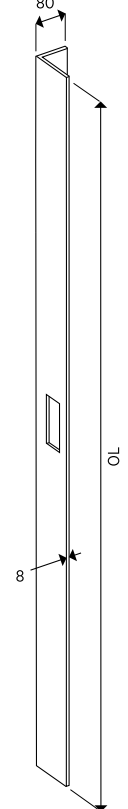
<p>art. DB2911PL</p>  <p>€ 618</p>	<p>art. DB2913PL</p>  <p>DETAIL Doorsnede trekker/ Coupe tirant</p> <p>€ 674</p>	<p>art. DB2914PL</p>  <p>DETAIL Doorsnede trekker/ Coupe tirant</p> <p>€ 562</p>	<p>art. DB2916PL</p>  <p>€ 618</p>	<p>art. DB2717PL</p>  <p>DETAIL Doorsnede trekker/ Coupe tirant</p> <p>€ 618</p>	<p>art. DB2917PL</p>  <p>DETAIL Doorsnede trekker/ Coupe tirant</p> <p>€ 618</p>
---	---	---	--	---	---

Maatwerk art.: zie tabel p. 164-165
Art. sur mesure : voir tableau p. 164-165

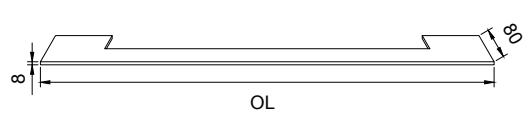
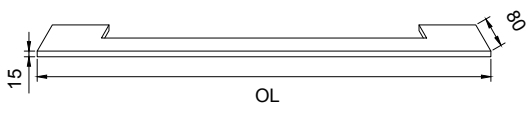
<p>art. DB2860PL</p>  <p>€ 501</p>	<p>art. DB2861PL</p>  <p>€ 501</p>
--	---

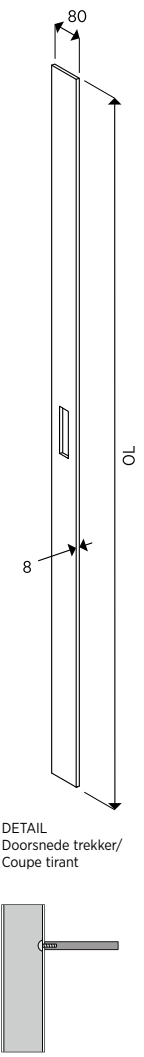
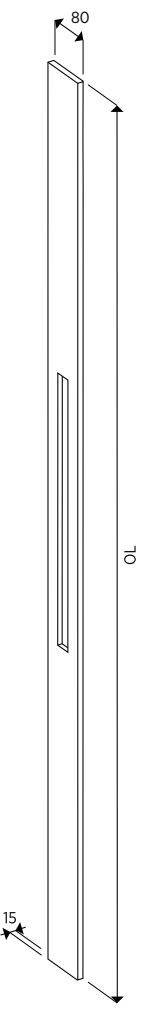
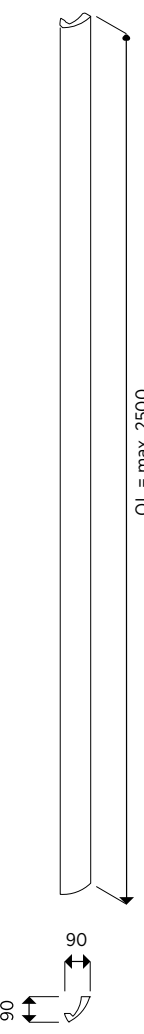
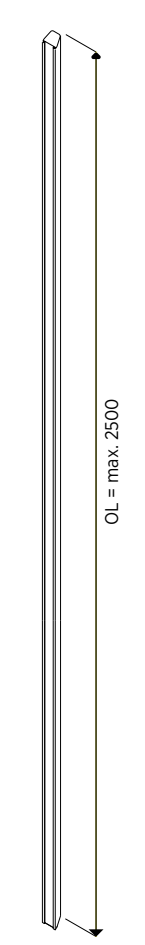
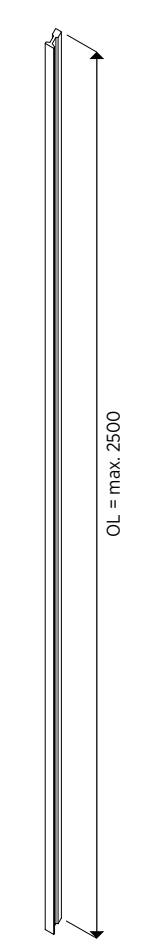
art. DB2918PL	art. DB2921PL	art. DB2950PL	art. DB2951PL	art. DB2952PL
 <p>DETAIL Doorsnede trekker/ Coupe tirant</p>		 <p>OL = max. 2500</p>	 <p>OL = max. 2500</p>	 <p>OL = max. 2500</p>
€ 618	€ 618	€ 618	€ 618	€ 618

Maatwerk art.: zie tabel p. 164-165
Art. sur mesure : voir tableau p. 164-165

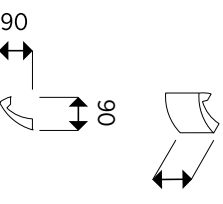
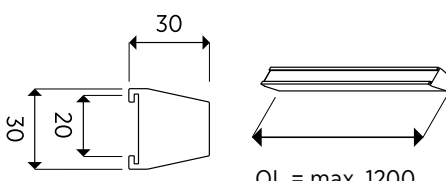
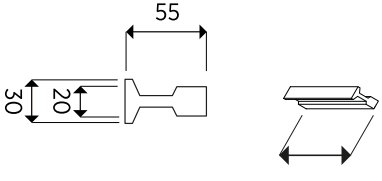
art. DB2850PL	art. DB2851PL	art. DB2852PL
 <p>OL = max. 1200</p>	 <p>OL = max. 1200</p>	 <p>OL = max. 1200</p>
€ 501	€ 501	€ 501

art. DB2960PL

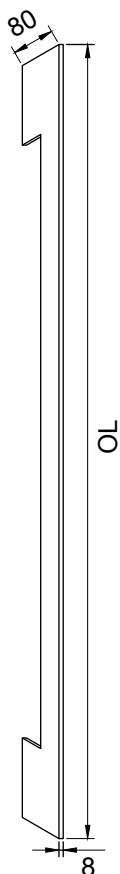

€ 618

art. DB2961PL



€ 618

art. DB2022PL

dikte | épaisseur 20 mm

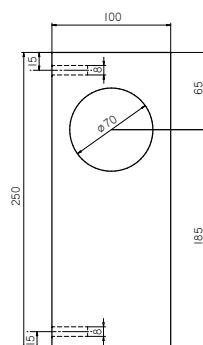

€ 454

art. DB2023PL

dikte | épaisseur 20 mm

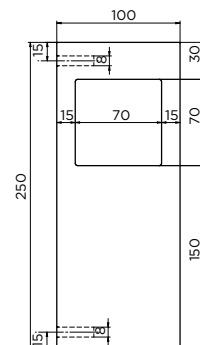

€ 454

art. DB2024PL

dikte | épaisseur 20 mm

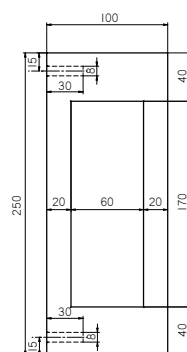

€ 454

art. DB2025PL

dikte | épaisseur 20 mm

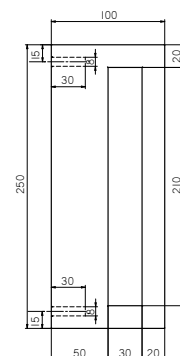

€ 454

Maatwerk art.: zie tabel p. 164-165
Art. sur mesure : voir tableau p. 164-165

art. DB2211PL

**NIEUW
NOUVEAU**

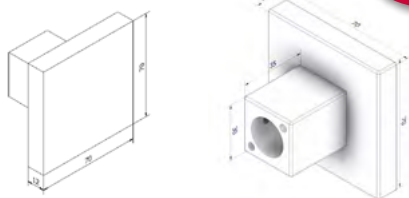

€ 424

art. DB2212PL

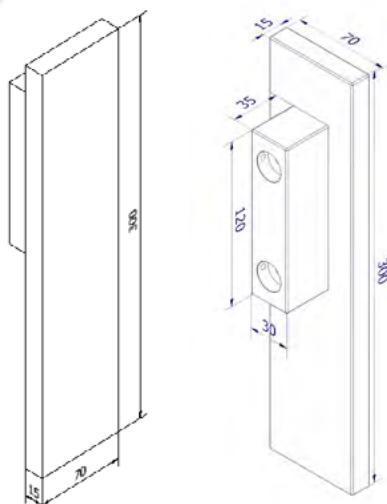

€ 424

art. DB7NEOPL

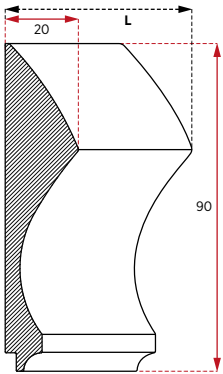

€ 294

art. DB7PASTORPL

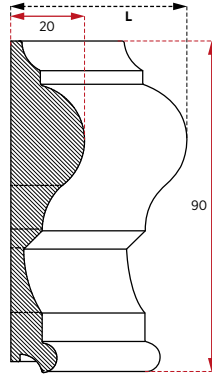

€ 294

art. DB7NOTAR-APL

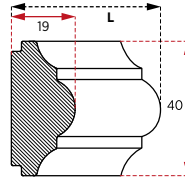

€ 212

art. DB7NOTAR-BPL

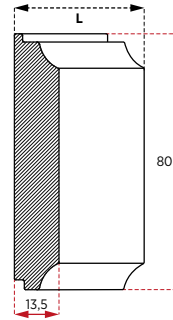

€ 212

art. DB7NOTAR-ABPL

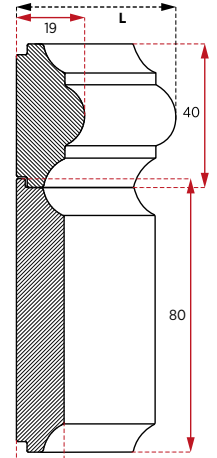

€ 424

NEO - PASTOR - NOTAR A NOTAR B - NOTAR A+B
OL max 3000 mm

NEO - PASTOR - NOTAR A
NOTAR B - NOTAR A+B
OL max 3000 mm



GRIEG - CAPLET



NOTAR A+B

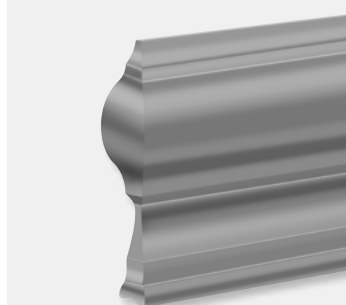

PASTOR

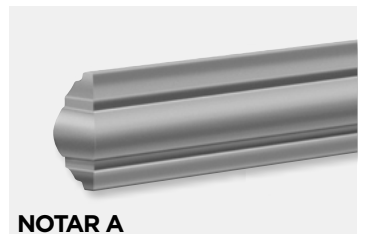

NOTAR A

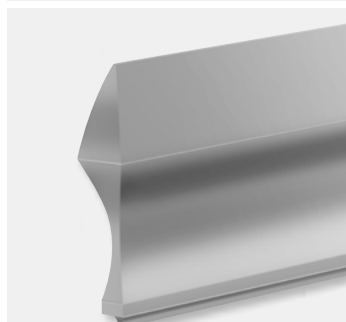

NEO



NOTAR B

TABEL ARTIKELN MAATWERK

TABLEAU ARTICLES SUR MESURE

INOX					
ART. ID	PARAM.	MIN [mm]	MAX [mm]	STAND.	PRIJS €
DB2134IN	AX	201	649	300	203
DB2135IN	AX	650	999	650	221
DB2136IN	AX	1000	2099	1000	270
DB2136IN	AX	2100	2500	-	383
DB2137IN	AX	201	499	300	187
DB2138IN	AX	500	999	500	202
DB2139IN	AX	1000	1600	1000	218
DB2139IN	AX	1601	2500	-	294
DB2140IN	AX	201	499	300	159
DB2141IN	AX	500	999	500	172
DB2142IN	AX	1000	1599	1000	191
DB2142IN	AX	1600	2500	-	265
DB2250IN	AX	201	499	300	277
DB2251IN	AX	500	999	500	313
DB2252IN	AX	1000	1800	1000	368
DB2253IN	AX	201	499	300	226
DB2254IN	AX	500	999	500	272
DB2255IN	AX	1000	1600	1000	328
DB2255IN	AX	1601	2500	-	547
DB2256IN	AX	201	499	300	293
DB2257IN	AX	1000	1800	1000	404
DB2259IN	AX	201	499	300	226
DB2260IN	AX	500	999	500	272
DB2261IN	AX	1000	1600	1000	327
DB2261IN	AX	1601	2500	-	404
DB2262IN	AX	500	999	500	349
DB2292IN	AX	201	999	500	543
DB2293IN	AX	1000	1800	1000	659
DB2297IN	AX	201	499	300	264
DB2298IN	AX	500	999	500	269
DB2299IN	AX	1000	1600	1000	277
DB2299IN	AX	1601	2400	-	358

PL					
ART. ID	PARAM.	MIN [mm]	MAX [mm]	STAND.	PRIJS €
DB2811PL	OL	160	1200	850	500
DB2813PL	OL	160	1200	850	594
DB2816PL	OL	200	1200	850	500
DB2817PL	OL	160	1200	850	500
DB2818PL	OL	160	1200	850	500
DB2821PL	OL	150	1200	850	500
DB2850PL	OL	90	1200	850	529
DB2851PL	OL	30	1200	850	529
DB2852PL	OL	55	1200	850	529
DB2860PL	OL	160	1200	850	500
DB2861PL	OL	150	1200	850	500
DB2911PL	OL	1320	2500	2000	618
DB2911PL	OL	2501	3000	-	725
DB2913PL	OL	1601	2500	2000	741
DB2913PL	OL	2501	3000	-	848
DB2914PL	OL	1601	2500	2000	618
DB2914PL	OL	2501	3000	-	725
DB2916PL	OL	1201	2500	2000	618
DB2916PL	OL	2501	3000	-	725
DB2917PL	OL	1040	2500	2000	618
DB2917PL	OL	2501	3000	-	725
DB2918PL	OL	1040	2500	2000	618
DB2918PL	OL	2501	3000	-	725
DB2921PL	OL	1315	2500	2000	618
DB2921PL	OL	2501	3000	-	725
DB2950PL	OL	1201	2500	2000	618
DB2950PL	OL	2501	3000	-	725
DB2951PL	OL	1201	2500	2000	618
DB2951PL	OL	2501	3000	-	725
DB2952PL	OL	1201	2500	2000	618
DB2952PL	OL	2501	3000	-	725
DB2960PL	OL	1040	2500	2000	618
DB2960PL	OL	2501	3000	-	725
DB2961PL	OL	1315	2500	2000	618
DB2961PL	OL	2501	3000	-	725
DB7NecPL	OL	50	2000	850	294
DB7NotarABPL	OL	50	2000	850	294
DB7NotarAPL	OL	50	2000	850	211
DB7NotarEPL	OL	50	2000	850	211
DB7PastorPL	OL	50	2000	850	423



Gezien de voortdurende prijsschommelingen in vlakke panelen worden hun prijzen voorlopig niet meer opgenomen in de gedrukte prijslijst. We verwijzen voor de actuele prijzen graag naar onze website www.frager.be waar u onder de downloads alle info terugvindt.

Vu les fluctuations des prix au niveau des panneaux lisses, ceux-ci ne seront temporairement plus repris dans le tarif imprimé. Nous nous référons à notre site www.frager.be où vous trouverez les prix et infos actuels dans les downloads.

brutoprijzen per plaat prix bruts par plaque			NL	FR	PVC	REN	REN	REN	RAL	RAL
					wit blanc • beige crème • 120 140	EXT folie filmé • INT 120 140	EXT folie filmé • INT 120 140	EXT folie filmé • INT folie filmé	EXT pistool pistolet • INT 120 140	EXT pistool pistolet • INT pistool pistolet
PRODUCT PRODUIT samenstelling composition	FORMAAT FORMAT (mm)	CAT. COLOR			STAND.	NT ST.				
HARICEL 10 mm - VP110 PVC Schuim Mousse PVC 	1250x 3000 mm	cat A	✓	✓	✓	✓	✓	✓	✓	✓
		cat B	-	✓	✓	✓	✓	✓	✓	✓
U-value = 2,60 W/m²K										
HARICEL 13 mm - VP113 PVC Schuim Mousse PVC 	1250 x 3000 mm	cat A	✓	✓	✓	✓	✓	✓	✓	✓
		cat B	-	✓	✓	✓	✓	✓	✓	✓
U-value = 2,40 W/m²K										
HARICEL 15 mm - VP115 PVC Schuim Mousse PVC 	1250 x 3000 mm	cat A	✓	✓	✓	✓	✓	✓	✓	✓
		cat B	-	✓	✓	✓	✓	✓	✓	✓
U-value = 2,20 W/m²K										
HARICEL 17 mm - VP117 PVC Schuim Mousse PVC 	1250 x 3000 mm	cat A	✓	✓	✓	✓	✓	✓	✓	✓
		cat B	-	✓	✓	✓	✓	✓	✓	✓
U-value = 2,10 W/m²K										

CAT A EN B: Een kleine set van folies en poeders onderscheiden zich op vlak van afwerking en aankoopprijs. Om de prijs van de andere afwerkingen laag te houden, verkopen we deze nu onder 'cat B'. De volledige materiaallijst met bijhorende categorieën is terug te vinden op de website www.frager.be.



STAND EN NT-STAND: Om prijzen te drukken, kopen we veel gevraagde folie-panelen in bulk aan. Een volledige lijst met standaard panelen is terug te vinden op de website www.frager.be.

CAT A ET B : un petit ensemble de feuilles et de poudres différent en termes de finition et de prix d'achat. Pour maintenir le prix des autres finitions à un niveau bas, nous les vendons maintenant sous "cat B." La liste complète des matériaux avec les catégories associées se trouve sur le site www.frager.be.

STAND ET NT-STAND : Pour imprimer les prix, nous achetons de nombreux panneaux filmé en vrac. Une liste complète des panneaux standard peut être consultée sur le site www.frager.be.

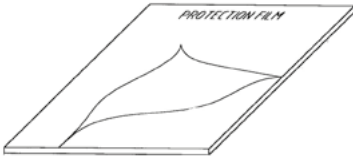
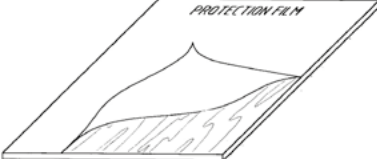
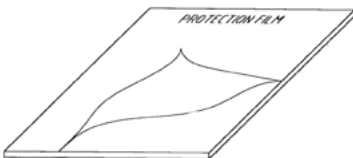

Gezien de voortdurende prijsschommelingen in vlakke panelen worden hun prijzen voorlopig niet meer opgenomen in de gedrukte prijslijst. We verwijzen voor de actuele prijzen graag naar onze website www.frager.be waar u onder de downloads alle info terugvindt.

Vu les fluctuations des prix au niveau des panneaux lisses, ceux-ci ne seront temporairement plus repris dans le tarif imprimé. Nous nous référons à notre site www.frager.be où vous trouverez les prix et infos actuels dans les downloads.

plaatmateriaal plaques			PVC	REN	RAL	RAL
brutoprijzen per plaat prix bruts par plaque  			wit blanc • beige crème	EXT folie filmé	EXT poeder poudre	EXT pistool pistolet
PRODUCT PRODUIT samenstelling composition	FORMAAT FORMAT (mm)	CAT. COLOR				
PLAQUE PVC PLAAT 1,5 mm - VP210 	900x2100	A	✓	-	-	-
		B	-	-	-	-
	1500x3000	A	✓	-	-	-
		B	-	-	-	-
PLAQUE HPL PLAAT 2,0 mm - VP220 	900x2100	A	-	✓	-	-
		B	-	✓	-	-
	1150x3000	A	-	✓	-	-
		B	-	✓	-	-
PLAQUE ALU PLAAT 1,5 mm - VP230 	1000x1080	A	✓	-	✓	✓
		B	-	-	✓	✓
	900x1050	A	✓	✓	✓	✓
		B	-	✓	✓	✓
	900x2100	A	✓	✓	✓	✓
		B	-	✓	✓	✓
	1080x2000	A	✓	-	✓	✓
		B	-	-	✓	✓
	1050x2200	A	✓	-	✓	✓
		B	-	-	✓	✓
	1250x2500	A	✓	-	✓	✓
		B	-	-	✓	✓
	1080x3000	A	✓	-	✓	✓
		B	-	-	✓	✓
	1150x3000	A	-	✓	-	-
		B	-	✓	-	-
	1500x3000	A	✓	-	✓	✓
		B	-	-	✓	✓

Gezien de voortdurende prijsschommelingen in vlakke panelen worden hun prijzen voorlopig niet meer opgenomen in de gedrukte prijslijst. We verwijzen voor de actuele prijzen graag naar onze website www.frager.be waar u onder de downloads alle info terugvindt.

Vu les fluctuations des prix au niveau des panneaux lisses, ceux-ci ne seront temporairement plus repris dans le tarif imprimé. Nous nous référons à notre site www.frager.be où vous trouverez les prix et infos actuels dans les downloads.

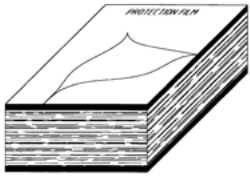
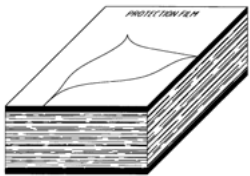
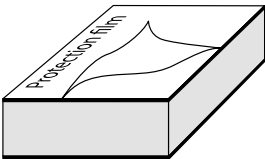
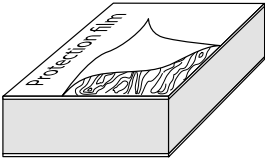
brutoprijzen per plaat prix bruts par plaque			 NL  FR	PVC	REN	REN
PRODUCT / PRODUIT samenstelling / composition	FORMAAT / FORMAT (mm)	CAT. COLOR	wit • beige crème • 120 140	EXT folie filmé • INT 120 140	EXT folie filmé • INT folie filmé	
MONTY MU 23 MM - VP310 	900x2100	A	✓	-	-	
		B	-	-	-	
FRAGER MU 24 mm* - VP350 	900x2100	A	✓	-	-	
		B	-	-	-	
* Zolang de voorraad strekt. Jusqu'à épuisement du stock.						
PVC HARFOAM 36 mm - VP320 	900x1050	A	✓	-	-	
		B	-	-	-	
	900x2100	A	✓	-	-	
		B	-	-	-	
	1500x3000	A	✓	-	-	
		B	-	-	-	
HPL HARFOAM 36/37 mm - VP330 	900x2100	A	-	✓	✓	
		B	-	✓	✓	
	1150x3000	A	-	✓	✓	
		B	-	✓	✓	
Andere kernen beschikbaar, zie p. 171 Autres âmes possible, voir p. 171						

Gezien de voortdurende prijsschommelingen in vlakke panelen worden hun prijzen voorlopig niet meer opgenomen in de gedrukte prijslijst. We verwijzen voor de actuele prijzen graag naar onze website www.frager.be waar u onder de downloads alle info terugvindt.

Vu les fluctuations des prix au niveau des panneaux lisses, ceux-ci ne seront temporairement plus repris dans le tarif imprimé. Nous nous référons à notre site www.frager.be où vous trouverez les prix et infos actuels dans les downloads.

		NL	FR	PVC	REN	REN	RAL	RAL	RAL
brutoprijzen per plaat prix bruts par plaque				wit blanc • beige crème • 120 140	EXT folie filmé • INT 120 140	EXT folie filmé • INT folie filmé	EXT poeder poudre • INT poeder poudre	EXT pistool pistolet • INT 120 140	EXT pistool pistolet • INT pistool pistolet
PRODUCT PRODUIT samenstelling composition	FORMAAT FORMAT (mm)	CAT. COLOR							
ALU HARFOAM 36 mm - VP340 Andere kernen beschikbaar, zie p. 171 Autres âmes possible, voir p. 171	1080x1000	A	✓	-	-	✓	✓	✓	
		B	-	-	-	✓	✓	✓	
	900x1050	A	-	✓	✓	-	-	-	
		B	-	✓	✓	-	-	-	
	900x2100	A	✓	✓	✓	✓	✓	✓	
		B	-	✓	✓	✓	✓	✓	
	1080x2000	A	✓	-	-	✓	✓	✓	
		B	-	-	-	✓	✓	✓	
	1050x2200	A	✓	-	-	✓	✓	✓	
		B	-	-	-	✓	✓	✓	
	1250x2500	A	✓	-	-	✓	✓	✓	
		B	-	-	-	✓	✓	✓	
	1080x3000	A	✓	-	-	✓	✓	✓	
		B	-	-	-	✓	✓	✓	
	1150x3000	A	-	✓	✓	-	-	-	
		B	-	✓	✓	-	-	-	
	1500x3000	A	✓	-	-	✓	✓	✓	
		B	-	-	-	✓	✓	✓	
ANODIC* HARFOAM 36 mm - VP360 	900x2100					✓			
	1500x3000					✓			
ANODIC* PLAAT 1,5 mm - VP270 	900x2100					✓			
	1500x3000					✓			

Gezien de voortdurende prijsschommelingen in vlakke panelen worden hun prijzen voorlopig niet meer opgenomen in de gedrukte prijslijst. We verwijzen voor de actuele prijzen graag naar onze website www.frager.be waar u onder de downloads alle info terugvindt.

Vu les fluctuations des prix au niveau des panneaux lisses, ceux-ci ne seront temporairement plus repris dans le tarif imprimé. Nous nous référons à notre site www.frager.be où vous trouverez les prix et infos actuels dans les downloads.

speciale kernen vlakke panelen | ames speciales panneaux lisses

SUPPL. HARFOAM PVC 1,5 mm pvc KERN-AME 1,5 mm pvc HPL 2 mm hpl KERN-AME 2 mm hpl ALU 1,5 mm alu KERN-AME 1,5 mm alu					bruto supplement - supplément brut								
					1080 x 1000	900 x 1050	900 x 2100	1080 x 2000	1050 x 2200	1250 x 2500	1080 x 3000	1150 x 3000	1500 x 3000
KERN/AME	DIKTE EPAISS. KERN/AME	DIKTE EPAISS. PVC/ALU	DIKTE EPAISS. HPL	U-VALUE W/M2K									
XPS 20	20	23	24	1,10	✓	✓	✓	✓	✓	✓	✓	✓	✓
MU 20	20	23	24	2,97	-	-	✓	-	-	-	-	-	-
ISOL+ 22	22	25	26	1,50	-	-	✓	-	✓	-	-	-	-
XPS 25	25	28	29	0,91	✓	✓	✓	✓	✓	✓	✓	✓	✓
XPS 30	30	33	34	0,78	✓	✓	✓	✓	✓	✓	✓	✓	✓
XPS 33 standaard/ standard.	33	36	37	0,72	✓	✓	✓	✓	✓	✓	✓	✓	✓
THERMIMAX 33	33	36	37	1,10	-	-	✓	-	✓	-	-	-	-
FLAMEBOARD 200+	35	38	39	1,30	-	-	✓	-	-	-	-	-	-
XPS 36	36	39	40	0,67	✓	✓	✓	✓	✓	✓	✓	✓	✓
ISOMIX 37	37	40	41	0,53	-	-	✓	-	✓	-	-	-	-
AMAC 38	38	41	42	2,38	-	-	✓	-	-	-	-	-	-
XPS 40	40	43	44	0,61	✓	✓	✓	✓	✓	✓	✓	✓	✓
ISOMIX 43	43	46	47	0,49	-	-	✓	-	✓	-	-	-	-
XPS 50	50	53	54	0,49	✓	✓	✓	✓	✓	✓	✓	✓	✓

1. VERWERKING

De panelen mogen niet onder de 18° C verwerkt worden. De panelen worden verzaagd met een formaatzaag met aangepast, goed snijdend WIDIA gereedschap, aangepast voor PVC of ALUMINIUM. Vooraleer een paneel te verzagen gelieve na te zien of het paneel beantwoordt aan uw bestelling. Een verzaagd of verwerkt paneel wordt niet teruggenomen.

2. PLAATSING

De panelen worden geplaatst zoals men dubbele beglazing in profielen plaatst, volledig met inachtneming van STS 38.03 (België) en BRL 0709 (Nederland). Onderaan wordt het paneel op kunststof stelblokjes geplaatst en in het onderprofiel is er om de 20 cm een waterafvoer van minimum diameter 8 mm. Alle waarborg vervalt indien stagnatie van water (condens en/of insijpelingswater) in de sponning niet doelmatig verhinderd werd, bij middel van een degelijke drainering. Er wordt diagonaal gecalleerd: onderaan kant scharnier en bovenaan kant slot. Bij ALU-panelen is de buitenste aluminiumplaat gevoeliger aan uitzetting door opwarming. Door dit zogenaamde bimetaal-effect kan het paneel gebogen staan. Na afkoeling herstelt zich deze toestand. Soms stellen we een restbuiging vast, omgekeerd evenredig met de sterkte van het gebruikte profiel. Calleren gebeurt dus uitsluitend op de binnenste aluminiumplaat, zodat de buitenste plaat niet opgespannen staat.

3. ONDERHOUD

Het onderhoud van onze panelen mag enkel gebeuren met lauwwater en zachte doek of spons. Andere specifieke onderhoudsproducten worden gebruikt op eigen risico. In elk geval nooit bijtende producten en/of schuurmiddelen gebruiken.

4. NABEWERKING

Op sierpanelen en vlakke panelen worden geen structurele oppervlakteveranderingen toegelaten. Wordt dit niettemin gedaan, kan er géén garantie meer gegeven worden op het oorspronkelijke paneel.

Lakwerk niet door onze firma uitgevoerd:

- Het lakken van alu panelen door derden gebeurt steeds op eigen risico. Er wordt vanzelfsprekend geen garantie gegeven op dit lakwerk, noch op de waterdichtheid van de eventuele glasafwerking.
- Het lakken van PVC panelen wordt afgeraden (donkere kleuren en het lakken van PVC-harfoam zijn alleszins nefast!!). Indien een PVC paneel extern wordt gelakt, dan vervalt de garantie volledig.

5. BEGLAZING

Fouten in het dubbel glas kunnen pas in aanmerking komen voor een klacht indien ze duidelijk zichtbaar zijn van op een afstand van 3 meter. Kleine luchtbelletjes in decoglas (type D) zijn inherent aan het productieproces en vallen dan ook niet onder garantie. De waarborg bepaalt dat beglazing met eventuele produktiefouten kosteloos wordt hermaakt en geleverd op de plaats van de eerste levering. Bijkomende kosten vallen niet onder garantie. Glasbreuk valt niet onder garantie.

6. KLEUR

A. POEDERLAK (Moffelwerk): zie kolom RAL poeder-poudre-powder

- Standaard RAL kleuren in poederlak:** Zie lijst op onze site www.frager.be
- Niet-standaard RAL kleuren in poederlak:** Dit zijn de kleuren niet vermeld op de online lijst. Voor deze kleuren wordt een minimum supplement aangerekend van € 350 bruto per paneel. Voor bestellingen in deze niet-standaardkleuren met een netto-aankoopprijs van minder dan € 750 netto, kunnen wij deze bestellingen weigeren, al zoeken wij vanzelfsprekend altijd naar een passende oplossing.

Belangrijke opmerking ivm poederlak:

- Bij het lakken met poeders van éénzelfde RAL nummer kunnen kleurschakeringen voorkomen, ten gevolge van verschillende poeder-lakprocedures en/of aangeleverde poeders;
- Kleine foutjes in poederlak zijn soms onvermijdelijk; als deze niet zichtbaar zijn vanaf 3 meter afstand, kunnen deze niet in aanmerking komen als garantie. (zie verder "Kleureisen")
- Er wordt nooit gelakt met poeders geleverd door de klant.

B. LAKNORMEN / KLEUREISEN ivm POEDERLAK & NATLAK

- Beschadigingen en onvolkomenheden
 - De coating mag op de directe zichtvlakken geen beschadigingen vertonen waardoor het metaal zichtbaar wordt.
 - Bij het bekijken van de gecoate zichtvlakken, loodrecht op het gelakte oppervlak, mogen er tijdens de keuring vóór montage, op een afstand van 3 meter, geen gebreken storend zichtbaar zijn zoals beschadigingen, ruw oppervlak, zakkers, insluitingen en gaten.
- Kleur en glansgraad
 - De coating moet wat kleur en glansgraad betreft gelijkmatig en dekkend zijn.
 - Voor buitentoepassing geldt een beoordelingsafstand van 5 meter.
 - Voor binnentoepassing geldt een beoordelingsafstand van 3 meter.

3. Laagdiktes

De minimale laagdiktes in micrometer dienen te voldoen aan volgende eisen:

MILIEU		RAL POWDER poederlak	RAL SPRAY natlak
buiten	- agressieve belasting	90 micron	70 micron
	- normale belasting	60 micron	50 micron
binnen	- natte omgeving	60 micron	50 micron
	- droge omgeving	30 micron	25 micron

Indien hogere laagdiktes vereist zijn, dient men rekening te houden met een meerprijs van + 75 EUR per zijde.

7. FORMATEN PANELEN

Gelieve er rekening mee te houden dat bij gekleurde FRALU-panelen -- vooral in pistoolak -- bovenaan enkele ophanggaatjes in het paneel zijn. Dit verkleint soms de totale zichtbaar te laten oppervlakte van het paneel met 2,5 cm aan de bovenzijde. Voor de symmetrie van de panelen worden in sommige modellen (Pvc, Renolit en aluminium) positioneringsgaten voorzien die de bruikbare hoogte met 2,5 cm verminderen.

DIKTE: de paneeldikte is aangegeven in de prijslijst: er is een tolerantie van 1 à 2 mm.

8. SYMMETRIE

Bij het verlijmen van binnen- en buitenblad van het paneel wordt erop toegezien dat dit volledig symmetrisch geschiedt. Bij panelen met lijnmotief is dit niet altijd 100 % mogelijk. Gelieve hiermee rekening te houden.

9. EVENTUELE TERUGNAME VAN PANELEN

Indien onze firma toestaat om een origineel paneel terug te nemen en te crediteren, geldt dit enkel op voorwaarde dat het paneel zich in een perfecte staat bevindt. Dit betekent: onverzaagd, onbewerkt en terug ingepakt in de originele verpakking inclusief folie en polystyreen. Zoniet kan er géén creditnota opgemaakt worden.

10. LEVERING

In België worden onze producten franco geleverd vanaf € 350 netto excl. BTW. In Nederland & Luxemburg & Frankrijk worden onze producten franco geleverd vanaf € 600 netto excl. BTW. Voor alle andere landen wordt de transportkosten geval per geval bepaald. Voor minder dan bovenstaande bedragen wordt standaard een NETTO transportkost aangerekend, eventueel ook zonder voorafgaand akkoord van de klant: € 45 voor België; € 80 voor Luxemburg, € 95 voor Frankrijk en Nederland. Per zending wordt er omwille van de hoge brandstof- en transportprijzen ook een extra transporttoeslag bijgerekend.

Alle klachten omtrent geleverde panelen dienen binnen de 24 u na de levering gemeld te worden. Anders kan er al sowieso géén gebruik meer gemaakt worden van de verzekering bij onze externe transportfirma. Bij eventuele beschadiging door transport MOET melding gemaakt worden op de leveringsbon, anders zal dit helaas niet aanvaard worden door onze transporteur.

11. GARANTIE - 10 JARIGE FABRIEKSGARANTIE

Er kan enkel garantie gegeven worden indien de hierboven aangehaalde gegevens strikt nageleefd worden.

Alle klachten moeten schriftelijk meegedeeld worden met vermelding van:

- Naam + adres particulier
- Telefoonnummer particulier
- Factuur/orderbevestiging met de gegevens van het paneel
- Zaagmaten van het paneel
- Foto van het paneel + detailfoto van het probleem.

De waarborg vangt aan op de factuurdatum van de eerste levering.

Garantiebepalingen beslag

Alle beslag en brievenbussen dienen geïsoleerd geplaatst te worden ten opzichte van het deurpaneel door middel van silicone.

Contact tussen 2 verschillende metalen kan schade berokkenen aan het lagere metaal op de tabel van Mendeljev.

• Voor messing artikels

Enkel met lauw water en zachte doek onderhouden - géén garantie
Bronskleurige artikels zijn in het algemeen resistenter dan koperkleurige.

• Voor inox (roestvrij staal) artikels:

10 jaar garantie mits regelmatig onderhoud met ENKEL water, zeep en spons. Schuursponsjes en inox zijn ONVERENIGBAAR en kunnen enkel aanleiding geven tot roestvorming!!!

• Voor zwarte artikels:

De verouderde look ontstaat door het aanbrengen van een natuurlijke donkere bijenwas, die de legering tevens beschermt tegen roestvorming. Bij buitengebruik wordt aanbevolen de artikelen regelmatig opnieuw te behandelen met donkere bijenwas.

12. ORDERBEVESTIGINGEN

Na de bestelling, ontvangt de klant altijd automatisch een orderbevestiging per mail. De klant wordt geacht deze steeds nauwkeurig te controleren, want zonder tegenbericht binnen de 24 uur na deze orderbevestiging wordt de bestelling in productie genomen zoals vermeld op deze bevestiging. De leveringstermijnen vermeld op de orderbevestiging zijn louter indicatief en niet bindend.

13. VERKOOPSVORWAARDEN

1. Door het feit overeenkomsten met ons af te sluiten erkent de koper deze voorwaarden te kennen en deze als integrerend bestanddeel van de overeenkomst te aanvaarden. Tenzij onze schriftelijke aanvaarding, zijn alle andersluidende voorwaarden van de medecontractanten ongeldig en niet tegenstelbaar.
2. Onze offerten alsmede aangegeven leveringstermijnen worden enkel bij wijze van benaderende inlichtingen gegeven, maar kunnen nooit enige verbintenis van onzenuwee meebrengen.
3. Elke verkoop wordt gesloten onder voorbehoud van goede referenties, wij behouden ons steeds het recht voor om de overeenkomst op te schorten en voldoende garantiebewijzen te vragen voor de goede uitvoering ervan.
4. Alle klachten op leveringen dienen schriftelijk op straffe van verval ingediend te worden binnen 24 uur na levering van de goederen. Eventuele reactie op laattijdige klachten vindt steeds plaats onder alle voorbehoud en zonder enige nadelige erkenning noch verzaking.
5. Wanneer een klacht omtrent gebrekkige koopwaar erkend wordt, onder partijen of in rechte, gaat onze verantwoordelijkheid niet verder dan vervanging van de betwiste goederen en sluit dan ook uitdrukkelijk om het even welke directe of indirecte schadevergoeding uit.
6. Alle klachten op facturen dienen schriftelijk ingediend binnen 3 dagen na ontvangst ervan.
7. De panelen moeten geplaatst worden zoals men dubbele beglazing in profielen plaatst, volledig met inachtneming van STS 38.03 (België) en BRL 0709 (Nederland).
8. De facturen zijn contant betaalbaar. Bij gehele of gedeeltelijke niet-betaling van de schuld op de vervaldag wordt, van rechtswege en zonder ingebrekestelling, het factuurbedrag verhoogd met een rente van 15 % per jaar.
9. In geval van gehele of gedeeltelijke niet-betaling van de schuld op de vervaldag zonder ernstige redenen wordt, na vergeefse ingebrekestelling het schuld-saldo verhoogd met 15% met een minimum van € 125,- en een maximum van € 1.860,- zelfs bij toekenning van termijnen van respijt.
10. Alle innings- en protestkosten zijn ten laste van de klant.
11. De goederen blijven onze volledige eigendom tot volledige betaling ervan, eventuele verwijltresten en strafbeding inbegrepen, dit in afwijking van art.1583 B.W. Niettegenstaande dit uitdrukkelijk voorbehoud van eigendom en retentie, zijn alle risico's betreffende het goed aan de koper overgedragen.
12. Voor alle geschillen zijn alleen de rechtbanken te Kortrijk bevoegd, en enkel de verkoper kan hiervan afwijken.

1. PRODUCTION

Les panneaux ne peuvent pas être traités sous une température inférieure à 18°C. Pour découper les panneaux, une scie réglable avec un outillage WIDIA bien affûté, approprié pour le PVC et l'aluminium est indispensable. Avant de découper le panneau, veuillez vérifier que le panneau soit conforme à votre commande. Nous ne re prenons pas les panneaux découpés ou usinés.

2. POSE

La pose des panneaux s'effectue de la même manière que la pose de double vitrages dans les profils, conformément aux normes STS 38.03 (Belgique) et BRL 0709 (Pays-Bas). Le panneau est placé sur des cales plastiques et dans le profil du dessous se trouve un écoulement d'eau tous les 20 cm avec un diamètre minimum de 8mm. Toute garantie est automatiquement annulée si la stagnation de l'eau (condensation et/ou infiltration de l'eau) dans le rainurage n'est pas évitée de manière efficace par le moyen d'un drainage solide.

Le calage se fait en diagonale : en bas du côté de la charnière et en haut du côté de la serrure. Pour les panneaux FRALU, la plaque aluminium est plus sensible à une dilatation par la chaleur. Par ce prétendu effet bilame, le panneau peut se galber. Après refroidissement, cette situation se répare. Cependant, parfois un léger cintrage peut persister, qui est inversement proportionnel à la résistance du profil utilisé.

Le calage se fait alors seulement sur la tôle alu intérieure pour permettre la dilatation de la tôle extérieure.

3. ENTRETIEN

L'entretien de nos panneaux ne peut se faire qu'avec de l'eau tiède et un chiffon doux ou une éponge. Les autres produits d'entretien seront utilisés à vos risques et périls. En tout cas, ne jamais utiliser de produits mordants ou des éponges grattantes de type "SPONTEX".

4. APRES-TRAITEMENT

Nous ne permettons pas de modifications structurelles de la surface de nos panneaux décoratifs et lisses.

En cas de non-respect, notre responsabilité ne peut en aucun cas être engagée !

Laquage de panneaux non-réalisé par notre société :

A. Le laquage des panneaux alu réalisé par un tiers est toujours à ses risques et périls. Il n'y a évidemment aucune garantie sur ce laquage.

B. Le laquage des panneaux PVC est à déconseiller (surtout les couleurs foncées et panneaux PVC-harfoam). Si un panneau PVC a été laqué par le client ou un tiers, la garantie est complètement annulée.

5. VITRAGE

Des défauts dans un double vitrage ne peuvent faire l'objet d'un SAV que dans le cas où le défaut est bien visible à une distance de 3 mètres. Des bulles d'air dans les vitrages déco (type D) sont propres au processus de fabrication et ne peuvent en aucun cas donner suite à un remplacement sous garantie. En cas de garantie, le vitrage non-conforme est refabriqué gratuitement et livré à la place de la première livraison. Les frais qui en découlent ne sont pas sous garantie. Des casses de vitrage ne font pas l'objet de garantie.

6. COULEUR

A. THERMOLAQUAGE (laqué au four) : voir colonne RAL poeder-poudre-powder

1. Couleurs RAL standards en thermolaquage (3):

Voir liste sur notre site Internet www.frager.be.

2. Couleurs RAL Non-standard en thermolaquage :

Ceci correspond aux couleurs qui ne sont pas mentionnées sur la liste disponible en ligne. Pour ces couleurs, un supplément minimum de 350€ brut par panneau vous est facturé. Pour les commandes dans ces couleurs hors standard, dont le prix d'achat net est inférieur à 750€, nous nous réservons le droit de refuser la commande. Toutefois, nous cherchons d'un commun accord la solution la plus adaptée.

Remarques importantes en ce qui concerne le thermolaquage:

- Au laquage de poudres d'un même numéro RAL, il peut y avoir des nuances de teinte, à la suite de procédés de thermolaquage différents et/ou de poudres différentes ;
- Des petits « points » dans le laquage sont inévitables ; si ceux-ci ne sont pas visibles à une distance de 3 mètres, on ne peut pas faire appel à la garantie (voir plus bas « Normes de laquages »);
- Thermolaquage avec poudres fournis par le client, n'est pas possible.

EN FRANCE

Vu le grand nombre de fournisseurs de poudre en France, le système est différent de la Belgique. Nous demandons alors de fournir la marque et le numéro de la poudre qui a été laquée sur les profilés.

Deux possibilités:

1. La poudre est en stock chez nous ---> nous laquons cette référence.
2. La poudre n'est pas en stock chez nous --> nous envoyons les échantillons des poudres en stock chez nous et vous comparez avec vos profilés. Vous nous reconfirmez alors ensuite la poudre qui se rapproche le plus de la couleur des profilés. Dans le second cas, nous ne pourrions pas être tenus pour responsables en cas de différence de teinte. Dans le cas où aucun échantillon de couleur ne convient, nous devrions commander la poudre et vous devrez tenir compte d'un supplément de minimum € 350 brut peu importe s'il s'agit d'une poudre structurée, mat, satiné ou brillant

B. NORMES DU LAQUAGE

1. Endommagements et imperfections
 - Des imperfections faisant apparaître la tôle aluminium, ne peuvent pas être visibles sur le panneau après le laquage.
 - Perpendiculairement, à une distance de 3 mètres, des imperfections telles que des endommagements, une surface rugueuse, des surplus de peinture,... ne peuvent pas être visibles sur le panneau laqué.

2. Couleur et brillance

- En ce qui concerne la couleur et l'éclat, le laquage doit être uniforme et couvrant;
- Pour une application extérieure, la distance d'appréciation est de 5 mètres;
- Pour une application intérieure, la distance d'appréciation est de 3 mètres.

3. Epaisseur des couches

L'épaisseur minimale des couches en micromètre doit remplir les conditions suivantes:

ENVIRONNEMENT		RAL POUDRE Thermolaquage	RAL PISTOLET Laquage humide
extérieur	- influence corrosive	90 microns	70 microns
	- influence normale	60 microns	50 microns
intérieur	- environnement humide	60 microns	50 microns
	- environnement sec	30 microns	25 microns

Si - pour des circonstances spéciales - une épaisseur de couche plus importante est requise, celle-ci fera l'objet d'une plus-value de 75 EUR par côté.

7. FORMATS DES PANNEAUX

Veillez tenir compte qu'avec les panneaux Fralu laqués, surtout en laquage au pistolet, la hauteur totale est réduite de 2,5 cm en haut du panneau à cause des trous qui forment les points de soutien pour le laquage. Pour la symétrie des panneaux, sur certains modèles Pvc, Renolit et Aluminium, des trous de positionnement sont prévus et réduisent ainsi la hauteur utilisable du panneau de 2,5 cm.

EPAISSEUR: l'épaisseur du panneau est indiquée dans le tarif même, il y a une tolérance de 1 à 2mm.

8. SYMETRIE

En collant la face extérieure et intérieure d'un panneau, on veille à ce que cela se fasse de façon parfaitement symétrique. Avec les panneaux "à lignes" ceci n'est pas toujours possible à 100%. Veuillez en tenir compte.

9. REPRISE EVENTUELLE DES PANNEAUX

Si notre société autorise de reprendre un panneau original pour faire un avoir après retour, cela sera uniquement valable à condition que ce panneau soit encore en parfait état. Cela signifie : non-débité, non-traité et bien emballé dans l'emballage d'origine. Veuillez à ce que le panneau soit toujours bien emballé avant de le retourner. Sinon, aucun avoir ne sera établi.

10. LIVRAISON

En Belgique, nos produits sont livrés Franco à partir de 350€ net HT; Au Luxembourg, nos produits sont livrés Franco à partir de 450€ net HT;

En France, nos produits sont livrés Franco à partir de 600€ net HT.

Pour tous les autres pays, les frais de port sont déterminés au cas par cas.

A cause des coûts de transport et du gazole extrêmement élevés, chaque expédition fera dorénavant l'objet d'une surcharge transport.

Si votre livraison n'atteint pas le Franco mentionné ci-dessus, votre commande sera systématiquement expédiée avec les frais de port ci-dessous:

- € 45 NET pour la Belgique;
- € 80 NET pour le Luxembourg;
- € 95 NET pour la France et les Pays Bas.

Toutes vos demandes de SAV concernant les panneaux livrés doivent nous parvenir dans les 24h qui suivent la livraison. Passé ce délai, nous n'aurons de toute façon plus la possibilité de faire appel à l'assurance de notre transporteur externe. En cas d'endommagement durant le transport, il est impératif de le notifier directement sur le bon de livraison sinon le transporteur risque de ne pas accepter cette demande.

11. GARANTIE DECENNALE

On ne peut faire appel à la garantie décennale que si les données mentionnées ci-dessus sont strictement observées.

Toutes réclamations doivent nous parvenir par écrit en mentionnant:

- Nom + adresse du particulier
- N° de téléphone du particulier
- Facture/Conf. de commande avec toutes les données du panneau
- Dimensions de découpe du panneau
- Photo du panneau + détail du problème

La garantie commence à compter à partir de la date de la facture du premier panneau.

Conditions de garantie pour les accessoires

Il doit y avoir une isolation entre tous les articles de quincaillerie, les boîtes aux lettres et le panneau de porte au moyen de silicone. Le contact direct entre les 2 différents métaux peut provoquer des dégâts au métal le plus léger selon le tableau de Mendeljev.

- Pour les articles en laiton :
A entretenir uniquement avec de l'eau tiède et un tissu doux – pas de garantie.
Les articles en laiton bronzé sont en général plus résistants que ceux en laiton poli.
- Pour les articles en inoxydable :
Garantie 10 ans à condition que l'article soit régulièrement entretenu avec uniquement de l'eau, du savon et une éponge.
Les éponges grattantes de type "SPONTEX" et l'inox ne sont pas compatibles et peuvent provoquer une formation de rouille.
- Pour les articles en NOIR :
L'apparence vieillie est créée grâce à l'application d'une cire d'abeille naturelle de couleur foncée qui protège l'alliage de toute formation de rouille. En cas d'usage à l'extérieur, il est recommandé de traiter régulièrement les articles à base de cire d'abeille de couleur foncée.

12. CONFIRMATIONS DE COMMANDE

Après la commande, le client reçoit systématiquement par fax ou par mail (au choix du client) une confirmation de commande.

Le client est censé la vérifier rigoureusement car sans avis contraire de sa part dans les 24h, la commande est prise en production comme indiqué sur la confirmation de commande. Les délais de livraison mentionnés sur la confirmation de commande sont à titre purement indicatif et susceptibles d'être modifiés en fonction de l'avancement de la production.

13. CONDITIONS DE VENTE

1. Par le fait de conclure avec nous, l'acheteur est réputé connaître ces conditions de vente et les accepte comme partie intégrante de notre convention. Sauf accord écrit de notre part, toute clause des co-contractants en contradiction avec les nôtres, est frappée de nullité et est non-opposable.
2. Les données contenues dans nos offres ainsi que nos délais de livraison ont un caractère purement indicatif, et ne nous lient en aucun cas.
3. Toute vente est faite sous réserve de bonnes références sur l'acheteur. Nous nous réservons le droit de suspendre les livraisons et de demander des garanties nous assurant une bonne fin du contrat.
4. Sous peine de nullité, toute réclamation doit nous être faite par écrit dans les 24 heures suivant la livraison. Notre réaction sur une réclamation introduite tardivement ne vaut pas renoncement à cette stipulation. Elle est faite sous réserve de tous droits et sans aveux préjudiciables.
5. Dans le cas où une réclamation sur les marchandises livrées est reconnue fondée, notre responsabilité se limite à la livraison d'un nouveau panneau, à l'exclusion expresse de tout dédommagement direct ou indirect.
6. Toute réclamation concernant nos factures devra être faite dans les trois jours suivant sa réception.
7. La pose des panneaux s'effectue de même façon que la pose des double vitrages dans les profils, conformément aux normes STS 38.03 (Belgique) et BRL 0709 (Pays-Bas).
8. Le paiement doit avoir lieu au comptant et net à Wielsbeke. En cas de non-paiement à la date d'échéance et sans mise en demeure préalable, enlevé d'un intérêt de 15% l'an.
9. En cas de non-paiement entier ou partiel de la dette à la date d'échéance sans raisons apparentes, après mise en demeure en vain, la créance sera augmentée de 15% avec un minimum de € 125 et un maximum de € 1.860, même en cas d'accordement de délai.
10. Tous frais de protêt ou d'encaissement sont à charge du client.
11. Les marchandises, y compris les éventuels intérêts de retard et frais de procédure, restent notre propriété jusqu'à leur paiement intégral, ceci par dérogation à l'article 1583 du O.C. En dépit de cette réservation expresse de propriété et de rétention, tout risque relatif à la marchandise livrée, est immédiatement transféré à l'acheteur.
12. Les tribunaux de Courtrai sont seuls compétents pour tous litiges et seul le vendeur peut faire dérogation à cette stipulation.

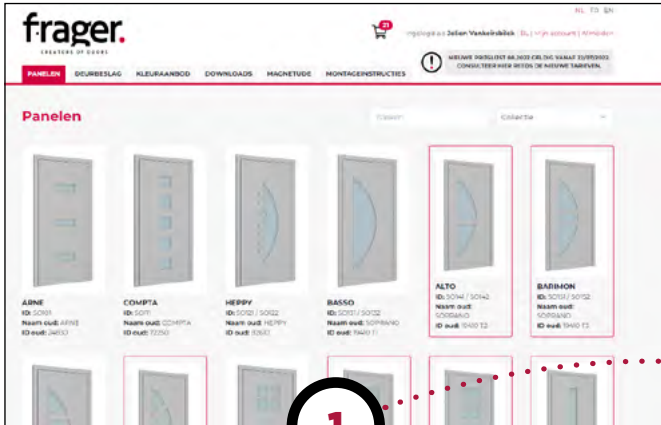

1

Kies een paneel
(een paneel met rood kader is maatwerk)

Choisir un panneau
(un panneau avec un cadre rouge est un panneau sur-mesure)

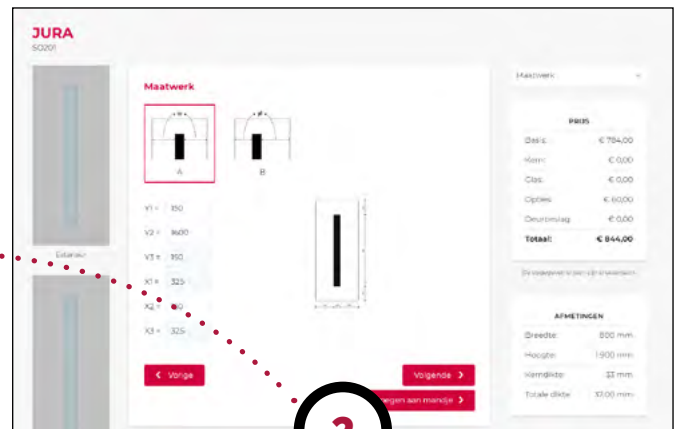

2

Vul de basis in

De afwerking kan met behulp van de dropdown gekozen worden.

Remplir la base de données

La finition peut être sélectionnée à l'aide du menu déroulant.

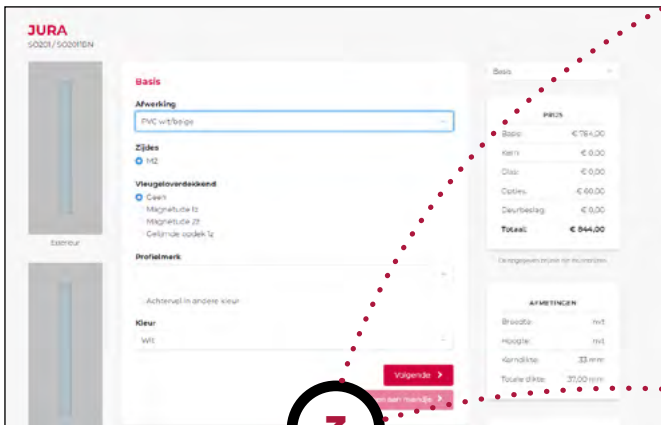

3

Vul de afmetingen van het paneel in
De kern kan gewijzigd worden via de dropdown.

Introduire les dimensions du panneau
L'âme peut être modifiée via le menu déroulant.

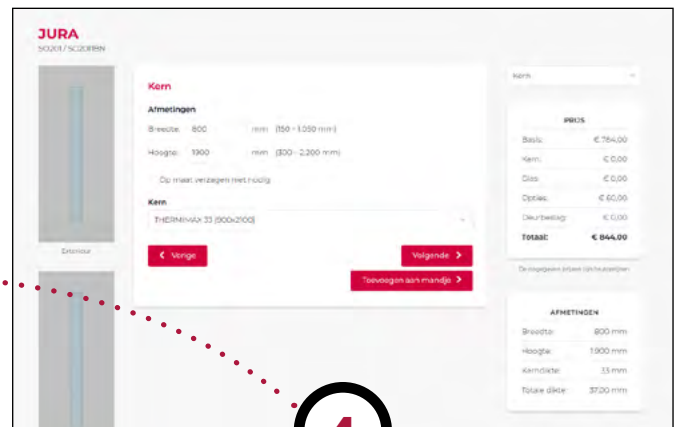

4

Het paneel bevat maatwerk

Het maatwerktafelblad verschijnt. Vul alle waarden in naar wens.

Personnalisation du panneau

L'onglet personnalisation apparaît. Entrez toutes les valeurs souhaitées.

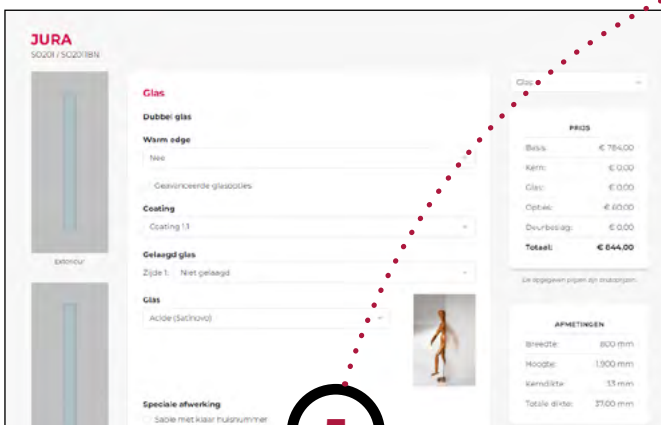

5

Het paneel bevat glas

Het glastafelblad verschijnt. Vul alle waarden in naar wens.

Le panneau contient du vitrage

L'onglet vitrage apparaît. Entrez toutes les valeurs souhaitées.

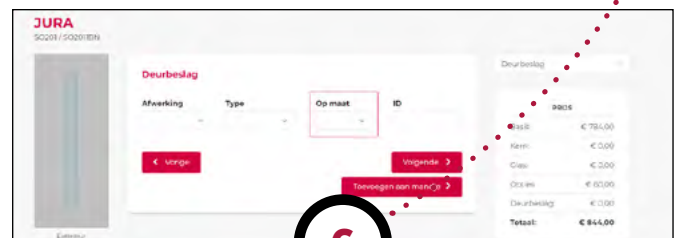

6

Deurbeslag

Er kan deurbeslag toegevoegd worden aan de configuratie.

Quincaillerie

La quincaillerie peut être ajoutée à la configuration.

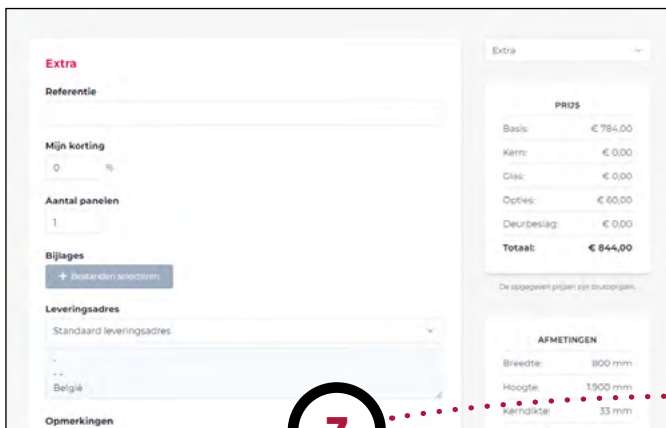

7

Extra's

Eventuele extra's kunnen hier genoteerd worden.

Suppléments

Tous les suppléments peuvent être notés ici.

Toevoegen aan mandje >

Ajouter au panier >

8

Bestel

Voeg de bestelling toe aan het mandje.

Commander

Ajouter la commande au panier.

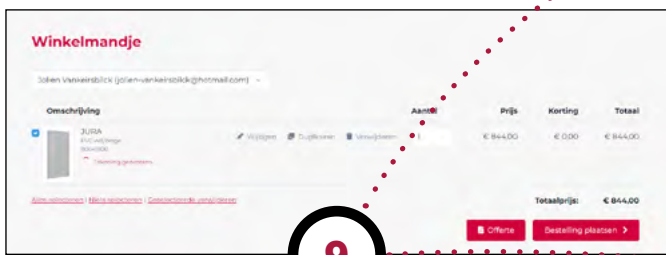

9

Winkelmandje

Indien het paneel maatwerk bevat en/of magnetude is wordt een tekening gegenereerd die goedgekeurd kan worden. Door de automatische generatie van de tekening wordt het goedkeuringsproces versneld.

Panier

Si le panneau est sur-mesure et/ ou Magnetude, un dessin peut être généré pour approbation. La génération automatique des dessins accélère le processus d'approbation.



10

PDF en 3D

Als deze gegenereerd is verschijnen twee doorklikicoontjes.

PDF et 3D

Une fois généré, deux icônes de clic apparaîtront.

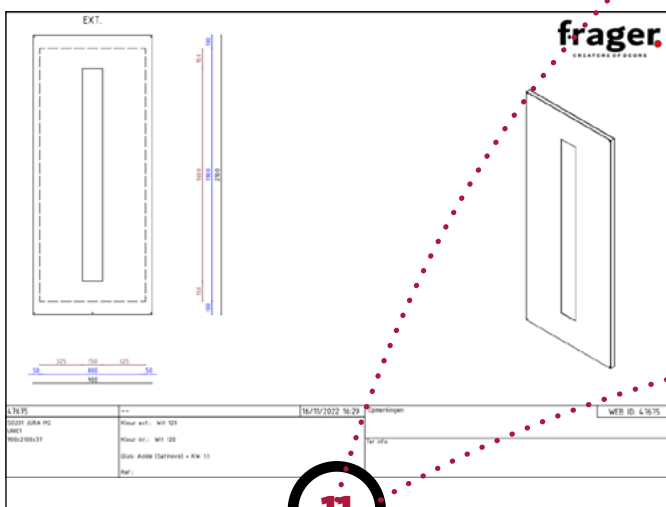

11

PDF en 3D

Als deze gegenereerd is verschijnen twee doorklikicoontjes.

PDF et 3D

Une fois généré, deux icônes de clic apparaîtront.



12

Tekening OK? Bestel!

De tekening voldoet naar wens? Klik op het "Tekening goeagekeurd" en bestel.

Dessin OK? Commander!

Le dessin vous convient? Cliquez sur "dessin approuvé" et commandez.



frager.
CREATORS OF DOORS

HARINCK nv/sa
Heirweg 95, zone 2
B-8710 Wielsbeke
info@frager.be

BELGIË/BELGIQUE
T +32 (0)56 67 40 50
F +32 (0)56 67 40 51
bestellingen@frager.be
commandes@frager.be

FRANCE
T +33 (0)3 20 30 07 98
F +33 (0)3 20 30 09 56
commandes@frager.be

www.frager.be