

## 2646ES SCISSOR LIFTS

A. Platform Height – Elevated	7.92 m
B. Platform Height – Lowered	1.26 m
C. Platform Railing Height	1.10 m
D. Stowed Height (Rails Folded)	1.97 m
E. Platform Size (W x L)	1.12 m x 2.50 m
F. Deck Extension	1.27 m
G. Overall Width	1.17 m
H. Overall Length	2.50 m
I. Wheelbase	2.09 m
J. Ground Clearance	0.13 m
Platform Capacity <sup>1</sup>	450 kg
Capacity on Optional Deck Extension	120 kg
Lift/Lower Time	40/50 sec.
Maximum Drive Height	7.92 m
Machine weight <sup>2</sup>	2,600 kg
Maximum Ground Bearing Pressure	6.90 kg/cm <sup>2</sup>
Drive Speed - Lowered	4.0 km/h
Drive Speed – Elevated	0.8 km/h
Gradeability	25%
Turning Radius – Inside	Zero
Turning Radius – Outside	2.41 m
Tyres (Non-Marking Solid)	406 x 125
Brakes	Automatic Friction - Front
Drive	24V Electric 6 kW
Batteries	4 x 6V 220 A/hr
Charger (120/240V – 50/60HZ)	20 Amp Automatic
Pump Motor	3 kW
Hydraulic System	20.0 L

**JLG Industries, Inc. is a leading designer and manufacturer of access equipment and complementary services and attachments.**

JLG has manufacturing facilities in the United States, France, Romania, China and Belgium. Customers throughout Europe, Scandinavia, Africa and the Middle East benefit from a network of dedicated sales and service operations designed to deliver the highest levels of support.

JLG is an Oshkosh Corporation company.

[www.jlgeurope.com](http://www.jlgeurope.com)

<sup>1</sup> Capacities shown are maximum with 2 persons indoor on all models. Outdoor ratings are: 2646ES – 2 person / 230 kg.  
<sup>2</sup> Certain options or country standards may increase weight and/or dimensions.

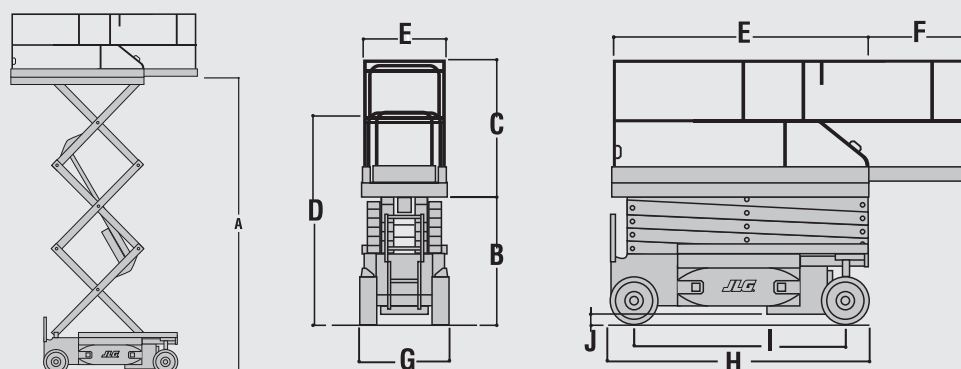

JLG is continually researching and developing products and reserves the right to make modifications without prior notice. All data in this document is indicative. Certain options or country standards will increase weight. Specifications may change to meet country standards or with the addition of optional equipment.